

CATERING - KITCHEN EQUIPMENT CATALOGUE

Hazırlık Ekipmanları
Preparation Equipment

Taşıma Ekipmanları
Carrying Equipment

Cafe Bar Ekipmanları
Cafe Bar Equipment

**Bulaşık Yıkama
Makineleri**
Dishwashers

Snack Serisi
Snack Series

700 Plus Serisi
700 Plus Series

900 Plus Serisi
900 Plus Series

Fırınlr
Ovens

Soğutma Ekipmanları
Cooling Equipment

Açık Büfe Sistemleri
Buffet Systems

İthal Ürünler
Import Products

Teşhir Ürünleri
Display Products

Raflar - Nötr Üniteler
Shelves - Neutral Units

andora

Hazırlık Ekipmanları Preparation Equipment



andora

HAZIRLIK EKİPMANLARI

Gastronom Küvet Vakumlama Kiti
Sebze Doğrama Makineleri
Sebze Doğrama Makinesi Silo Yüklemeli
Sebze Doğrama Makinesi Bıçakları
Soğan Doğrama Makineleri
Sebze Parçalama Makineleri ve Öğütücüler
Sebze Parçalama Makineleri
Hamur Yoğurma Makineleri (Tekerlekli)
Çift Devirli Spiral Hamur Yoğurma Makineleri (Tekerlekli)
Tek Devirli Spiral Hamur Yoğurma Makineleri (Tekerlekli)
Hamur Açma Makineleri
Hamur Kestart Makinesi
Üç Hızlı Mikserler
Hız Kontrollü Mikserler
Paslanmaz Et Kıyma Makineleri
Paslanmaz Soğutmalı Et Kıyma Makineleri
PLUS Paslanmaz Et Kıyma Makineleri
Et ve Kemik Testereleri
Patates Soyma Makineleri
Filtreli Patates Soyma Makineleri
Sebze Yıkama ve Kurutma Makineleri
Sebze ve Salata Kurutma Makineleri
Lokma ve Tulumba Tatlı Makineleri
Lokma ve Tulumba Tatlı Makine Tezgahları
Tulumba ve Köfte Şekillendirme Makineleri
Tabak Kapatma Makineleri
Bardak Kurutma Makineleri
Çatal Kaşık Parlatma Makineleri
Ekmek Dilimleme Makineleri
Ekmek Dilimleme - Simit ve Sandviç Kesme Makineleri
Streç ve Vakum Makineleri
Bıçak Sterilizatörü
Profesyonel Duvar Tipi Izgaralar
Kumpir Fırınları
Elektrikli Piliç Kızartma Makineleri
Gazlı Piliç Kızartma Makineleri
Plus Piliç Kızartma Makineleri
Kömürlü Yatay Piliç Kızartma Makineleri
Elektrikli Isıtmalı Teşhir Üniteleri
El Yıkama Evyeleri

PREPARATION EQUIPMENT

Vacuum Container Vacuuming Kit
Vegetable Cutters
Vegetable Cutter with Silo
Vegetable Cutter Blades
Cutter Mixers
Cutter Mixers and Grinders
Vertical Cutter Mixers
Dough Kneading Machines (with Wheels)
Double Speed Spiral Dough Mixer (with Wheels)
Mono Speed Spiral Dough Mixer (with Wheels)
Dough Roller Machines
Dough Weighing Machine
3 Speed Mixers
Speed Controlled Mixers
Stainless Steel Meat Miners
Stainless Steel Refrigerated Meat Miners
PLUS Stainless Steel Meat Miners
Anodized Bone Saws
Potato Peeler Machines
Filtred Potato Peeler Machines
Vegetable Washing and Dryer Machines
Salad and Vegetable Dryers
Doughnut and Tulumba Dessert Machines
Doughnut and Tulumba Dessert Machine Tables
Semolina Pasta Preparation and Meatball Shapers
Meal Seal Machines
Glass Dryer Machines
Cutlery Polisher Machines
Bread Slicer Machines
Baguette Bread Slicer - Pretzel and Sandwich Slicer Machines
Cling Film and Vacuum Machines
Knife Sterilizer
Professional Wall Type Grill
Potato Baking Ovens
Electrical Chicken Rotisserie
Gas Chicken Rotisserie
Plus Chicken Rotisserie
Horizontal Chicken Rotisserie with Charcoal
Food Warmer Display
Hand Wash Sinks



Sıvı Gıdaların Vakumlanması İçin Uygundur.
Suitable for the Purpose of Vacuuming Liquid foods.

Kod Code	Ürün Adı Description	Ebatlar Dimension a x b x c (mm)	Ağırlık Weight (kg)	Net Net (m ³)	Güç Power (kw)	Kapasite Capacity (lt)
AND.VCM.01 -GN	Vakum Makinesi Vacuum Machine	435x355x540	36	0.07	0.4	
AND.GN.100	Vac-Norm Küvet 1/1-100 Gn Vac-Norm Gn Container 1/1-100 Gn	530x325x100	2.2	0.017		15
AND.GN.150	Vac-Norm Küvet 1/1-150 Gn Vac-Norm Gn Container 1/1-150 Gn	530x325x150	2.7	0.026		20.5
AND.GN.200	Vac-Norm Küvet 1/1-200 Gn Vac-Norm Gn Container 1/1-200 Gn	530x325x200	3.2	0.035		27
AND.GN.K	Vac-Norm Küvet Kapağı 1/1 Gn Vac-Norm Lid 1/1 Gn	530x325	1.8	0.02		
AND.G.11	Vac-Norm Kapak Contası - Harici Conta Vac-Norm Gn Lid Gasket - External Gasket					
AND.V.11	Vac-Norm Sübap Vac-Norm Valve					

TEKNİK ÖZELLİKLER

- 220V. 50 Hz elektrik bağlantısı.
- 10 m³/h pompa kapasitesi.
- Otomatik kontrol.
- Paslanmaz çelik gövde.

TECHNICAL SPECIFICATIONS

- 220V. 50 Hz electric connection.
- Pump capacity: 10m³/h
- Automatic control.
- Stainless steel body.

Gn Kalınlığı : 1.20 mm / Gn Thickness is 1.20 mm

Conta ve Sübap Fiyata Dahildir. / Gasket and Valve are Included In Lids Price.



AND.VCM.01-GN



AND.GN.CONTAINER



AND.GN.K



AND.G.11



AND.V.11

Hazırlık Ekipmanları
Preparation Equipment**Sebze Doğrama Makineleri**
Vegetable Cutters

andora



AND.300



AND.400



Kod Code	Ürün Adı Description	Ebatlar Dimension	Ağırlık Weight	Net Net	Kapasite Capacity
		a x b x c (mm)	(kg)	(m ³)	(kg/saat-kg/hour)
AND.300	Sebze Doğrama Makinesi Vegetable Cutter	295x495x674	35	0.10	300
AND.300-AS	Sebze Doğrama Makinesi Alt Standlı Vegetable Cutter with Bottom Stand	420x495x1155	39	0.25	300
AND.400	Sebze Doğrama Makinesi Vegetable Cutter	295x495x723	37	0.11	400
AND.400-AS	Sebze Doğrama Makinesi Alt Standlı Vegetable Cutter with Bottom Stand	420x495x1199	41	0.26	400

TEKNİK ÖZELLİKLER

- Paslanmaz çelik bıçaklar.
- Kolay değiştirilebilir bıçaklar.
- Güvenlik sensörü.
- Alüminyum üst gövde.
- Paslanmaz çelik gövde.

AND.300

- 0.55 kW 1400 D/Dk-220V motor gücü.

AND.400

- 0.75/80 kW 1500-3000 D/Dk-380V motor gücü.

TECHNICAL SPECIFICATIONS

- Stainless steel blades.
- Blades can be easily removed for cleaning.
- Safety sensor.
- Aluminium top body
- Stainless steel body.

AND.300

- Motor power: 0.55 kW 1400 rpm -220V

AND.400

- Motor power: 0.75/80 kW 1500-3000 rpm -380V



AND.300-AS / AND.400-AS

Standart Bıçaklar / Standard BladesAND.300 - F.01
2-8 mm ayarlanabilir
dilimleme bıçağı.
1.8-8 mm adjustable
slicing blade.AND.300 - F.03
5 mm Rende
5 mm GraterAND.300 - F.04
7 mm Rende
7 mm Grater

2 Başlıklı Değişebilir Yükleme Sistemi
 2 Changeable Head Loading System

Kod Code	Ürün Adı Description	Ebatlar Dimension	Ağırlık Weight	Net Net	Kapasite Capacity
		a x b x c (mm)	(kg)	(m ³)	(kg/saat-kg/hour)
AND.800	Sebze Doğrama Makinesi Silo Yüklemeli Vegetable Cutter with Silo	370x885x1335	60	0.43	800-1000

TEKNİK ÖZELLİKLER

- 0.75/80 kW 1500-3000 D/Dk-380V motor gücü.
- Paslanmaz çelik bıçaklar.
- Çift devirli çalışma sistemi.
- Kolay değiştirilebilir bıçaklar.
- Güvenlik sensörü.
- Alüminyum üst gövde.
- Paslanmaz çelik gövde.
- Full bıçak seti.

TECHNICAL SPECIFICATIONS

- Motor power: 0.75/80 kW 1500-3000 rpm - 380V
- Stainless steel blades.
- Double speed working system.
- Blades can be easily removed for cleaning.
- Safety sensor.
- Aluminium top body
- Stainless steel body.
- Full blade set.

Standart Bıçaklar / Standard Blades

 AND.300 - F.01
 2-8 mm ayarlanabilir
 dilimleme bıçağı.
 1.8-8 mm adjustable
 slicing blade.

 AND.300 - F.03
 5 mm Rende
 5 mm Grater

 AND.300 - F.04
 7 mm Rende
 7 mm Grater

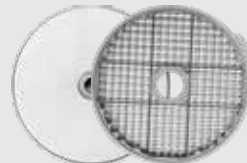
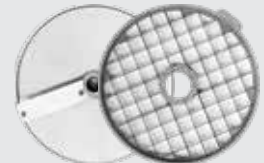
 AND.300 - F.06+F.07 Parmak
 Patates Bıçağı+Alt Diski French
 Fries Blade+Disc

 AND.300 - F.11+F.08 10x10
 mm Kubik Disk+Bıçağı 10x10
 mm Cubic Disc+Blade

 AND.300 - F.12+F.09 20x20
 mm Kubik Disk+Bıçağı 20x20
 mm Cubic Disc+Blade

Hazırlık Ekipmanları
Preparation EquipmentSebze Doğrama Makinesi Bıçakları
Vegetable Cutter Blades

andora

Kod
CodeÜrün Adı
Description

AND.300 - F.01

Ayarlanabilir Disk
Adjustable Disc2/8 mm ayarlanabilir dilimleme bıçağı.
2/8 mm adjustable slicing blade.Kod
CodeÜrün Adı
Description

AND.300 - F.03

5 mm Rende
5 mm GraterKod
CodeÜrün Adı
Description

AND.300 - F.04

7 mm Rende
7 mm GraterKod
CodeÜrün Adı
Description

AND.300 - F.06+F.07

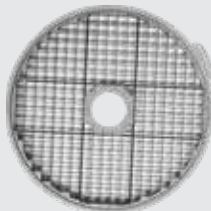
Parmak Patates Bıçağı+Alt Diski
French Fries Blade+DiscKod
CodeÜrün Adı
Description

AND.300 - F.11+F.08

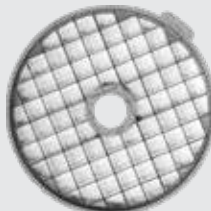
10x10 mm Kubik Disk+Bıçağı
10x10 mm Cubic Disc+BladeKod
CodeÜrün Adı
Description

AND.300 - F.12+F.09

20x20 mm Kubik Disk+Bıçağı
20x20 mm Cubic Disc+Blade



Kod Code	Ürün Adı Description	Ebatlar Dimension	Ağırlık Weight	Net Net
		a x b x c (mm)	(kg)	(m ³)
ASD.01Y	Soğan Doğrama Makinesi Cutter Mixer	340x500x390	18	0.06

TEKNİK ÖZELLİKLER

- 0,37 kW 1400 D/Dk - 220V motor gücü.
- Paslanmaz kazan ölçüleri (çap/derinlik): 240x175 mm
- Güvenlik sensörü.
- Paslanmaz gövde ve kazan.

TECHNICAL SPECIFICATIONS

- Motor power: 0,37 kW 1400 rpm - 220V
- Bowl dimension (diameter/depth): 240x175 mm
- Safety sensor.
- Stainless steel body and bowl.



Kod Code	Ürün Adı Description	Ebatlar Dimension	Ağırlık Weight	Net Net	Kapasite Capacity
		a x b x c (mm)	(kg)	(m ³)	(lt)
AND.350	Soğan Doğrama Makinesi Cutter Mixer	245x360x550	19	0.05	8

TEKNİK ÖZELLİKLER

- 0,37 kW 900 D/Dk - 220V motor gücü.
- Paslanmaz çelik kazan ölçüleri: 240x175 mm
- Güvenlik sensörü.
- Paslanmaz gövde ve kazan.

TECHNICAL SPECIFICATIONS

- Motor power: 0,37 kW 900 rpm - 220V
- Bowl dimension(diameter/depth): 240x175 mm
- Safety switch.
- Stainless steel body and bowl.

Hazırlık Ekipmanları
Preparation EquipmentSebze Parçalama Makineleri ve Öğütücüler
Cutter Mixers and Grinders

andora



Kod Code	Ürün Adı Description	Ebatlar Dimension	Ağırlık Weight	Net Net	Kapasite Capacity
		a x b x c (mm)	(kg)	(m ³)	(gr/sefer-gr/run)
ASD.06	Öğütücü Grinder	395x300x420	17	0.05	800

TEKNİK ÖZELLİKLER

- Paslanmaz çelik kazan ölçüleri: 240x90 mm
- Güvenlik sensörü.
- Malzeme özelliğini bozmadan yağ ve öz sularını çıkarmadan öğütme imkanı.
- Kapağa ve hazneye bağlı emniyet sensörleri.
- Her iki yöne devirmeli boşaltma imkanı.
- 220-240V 50-60 Hz - 6400/15000 Rpm motor.

TECHNICAL SPECIFICATIONS

- Bowl dimension (diameter/depth): 240x90 mm
- Safety switch.
- Possibility of grinding without removing the oil and juice without disturbing the material feature.
- Simple usage and serial work ability.
- Possibility of tipping in both directions.
- Motor power: 220-240V 50-60 Hz-6400/15000 Rpm



Kod Code	Ürün Adı Description	Ebatlar Dimension	Ağırlık Weight	Net Net	Kapasite Capacity
		a x b x c (mm)	(kg)	(m ³)	(lt)
ASD.15	Sebze Parçalama Makinesi Cutter Mixer	470x640x545	46	0.12	15

TEKNİK ÖZELLİKLER

- Paslanmaz kazan ölçüleri (çap/derinlik): 300x220 mm
- Kolay çıkarılabilir bıçak ve kazan.
- Çift devirli zaman ayarlı kontrol panosu.
- Güvenlik sensörü.
- 0.60 - 0.90 kW 750/1500/Dk - 380V motor gücü.

TECHNICAL SPECIFICATIONS

- Bowl dimension (diameter/depth): 300x220 mm
- Easy removable blade and bowl.
- Double circuit timer control panel.
- Safety sensor.
- Motor power: 0.60-0.90 kW 750/1500 rpm-380V

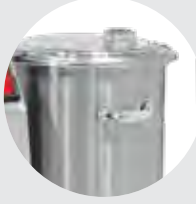
**20 lt**
Kapasite
Capacity**50 lt**
Kapasite
Capacity

Kod Code	Ürün Adı Description	Ebatlar Dimension	Ağırlık Weight	Net Net	Kazan Ebatları Bowl Size	Kapasite Capacity
		a x b x c (mm)	(kg)	(m ³)	(mm)	(lt)
ASD.07	Sebze Parçalama Makinesi Vertical Cutter Mixer	610x645x1045	71	0.40	300x300	20
ASD.07-22	Hız Kontrollü Sebze Parçalama Makinesi Speed Control Vertical Cutter Mixer	615x685x1050	67	0.40	300x300	20
ASD.09	Sebze Parçalama Makinesi Vertical Cutter Mixer	720x685x1250	112	0.60	400x400	50

TEKNİK ÖZELLİKLER

- Parçaların sökülebilir olması sayesinde kolay temizlik imkanı.
- Kolay çıkarılabilir bıçak ve kazan.
- Zaman ayarlı kontrol panosu.
- Güvenlik sensörü.
- Paslanmaz gövde ve kazan.
- Malzeme özelliğini bozmadan yağ ve öz sularını çıkarmadan öğütme imkanı.
- Basit kullanım ve seri iş kabiliyeti.
- Kapağa ve hazneye bağlı çalışan emniyet sensörleri.
- Sessiz ve titreşimsiz çalışma özelliği.

ASD.07

- 1.5/2.5 kW 750/1500 D/Dk - 380V motor gücü.

ASD.07-22

- Hız kontrollü çalışma özelliği.
- 2.2 kW 1500 D/Dk - 220V motor gücü.

ASD.09

- 3.5/5.5 kW 750/1500 D/Dk - 380V motor gücü.

TECHNICAL SPECIFICATIONS

- Easy cleaning by the removable parts.
- Easy removable blade and bowl.
- Time adjustable control panel.
- Safety sensor.
- Stainless steel body and bowl.
- Possibility of grinding without removing the oil and sap without disturbing the material feature.
- Simple usage and serial work ability.
- Safety switch connected to the lid and the chamber.
- Silent and without vibration working.

ASD.07

- Motor power: 1.5/2.5 kW 750/1500 rpm - 380V

ASD.07-22

- Speed controlled operating option.
- Motor power: 2.2 kW 1500 rpm - 220V

ASD.09

- Motor power: 3.5/5.5 kW 750/1500 D/Dk - 380V

**Standart Bıçak / Standard Blade**

Hazırlık Ekipmanları
Preparation EquipmentHamur Yoğurma Makineleri (Tekerlekli)
Dough Kneading Machines (with Wheels)

andora

Kapaklı
with LidTekerlekli
with Wheels

Kod Code	Ürün Adı Description	Ebatlar Dimension	Ağırlık Weight	Net Net	Kazan Ebatları Bowl Size	Un Kap. Flour Cap.
		a x b x c (mm)	(kg)	(m ³)	(mm)	(kg)
AHY.11.K	Hamur Yoğurma Makinesi 15 kg 220V Dough Kneading Machine 15 kg 220V	424x700x647	58	0.19	360x190	7
AHY.12.K	Hamur Yoğurma Makinesi 15 kg 380V Dough Kneading Machine 15 kg 380V	424x700x647	58	0.19	360x190	7
AHY.01.K	Hamur Yoğurma Makinesi 30 kg 220V Dough Kneading Machine 30 kg 220V	550x860x780	78	0.25	430x225	12
AHY.02.K	Hamur Yoğurma Makinesi 30 kg 380V Dough Kneading Machine 30 kg 380V	550x860x780	78	0.25	430x225	12
AHY.03.K	Hamur Yoğurma Makinesi 40 kg 220V Dough Kneading Machine 40 kg 220V	610x910x780	92	0.40	500x270	20
AHY.04.K	Hamur Yoğurma Makinesi 40 kg 380V Dough Kneading Machine 40 kg 380V	610x910x780	92	0.40	500x270	20
AHY.05.K	Hamur Yoğurma Makinesi 50 kg 220V Dough Kneading Machine 50 kg 220V	646x955x794	106	0.49	600x290	30
AHY.06.K	Hamur Yoğurma Makinesi 50 kg 380V Dough Kneading Machine 50 kg 380V	646x955x794	106	0.49	600x290	30
AHY.07.K	Hamur Yoğurma Makinesi 75 kg 220V Dough Kneading Machine 75 kg 220V	815x1130x882	140	0.78	750x350	50
AHY.08.K	Hamur Yoğurma Makinesi 75 kg 380V Dough Kneading Machine 75 kg 380V	815x1130x882	140	0.78	750x350	50

TEKNİK ÖZELLİKLER

- Acil stop.
- Paslanmaz çelik hamur karıştırma kolu ve kazan.
- Kapak açıldığında otomatik durduran switch özelliği.
- Sarsıntısız ve gürültüsüz çalışma özelliği.

AHY.11.K / AHY.12.K

- 0.37 kW 1400 D/Dk 220V - 380V motor gücü.

AHY.01.K / AHY.02.K

- 0.55 kW 1400 D/Dk 220V - 380V motor gücü.

AHY.03.K / AHY.04.K

- 0.55 kW 1400 D/Dk 220V - 380V motor gücü.

AHY.05.K / AHY.06.K

- 0.75 kW 1400 D/Dk 220V - 380V motor gücü.

AHY.07.K / AHY.08.K

- 1.10 kW 1400 D/Dk 220V - 380V motor gücü.

TECHNICAL SPECIFICATIONS

- Emergency stop.
- Stainless steel bowl and dough mixer arm.
- Automatic stopper switch feature when the cover is opened.
- Silent and without vibration working.

AHY.11.K / AHY.12.K

- Motor Power: 0.37 kW 1400 rpm / 220V - 380V

AHY.01.K / AHY.02.K

- Motor Power: 0.55 kW 1400 rpm / 220V - 380V

AHY.03.K / AHY.04.K

- Motor Power: 0.55 kW 1400 rpm / 220V - 380V

AHY.05.K / AHY.06.K

- Motor Power: 0.75 kW 1400 rpm / 220V - 380V

AHY.07.K / AHY.08.K

- Motor Power: 1.10 kW 1400 rpm / 220V - 380V





Kapaklı
with Lid



Tekerlekli
with Wheels

Kod Code	Ürün Adı Description	Ebatlar Dimension	Ağırlık Weight	Net Net	Un Kap. Flour Cap.	Kapasite Capacity
		a x b x c (mm)	(kg)	(m ³)	(kg)	(lt)
ASH.01	Spiral Hamur Yoğurma Makinesi 30 kg 380 V Spiral Dough Mixer 30 kg 380 V	432x792x987	174	0.34	12	30
ASH.02	Spiral Hamur Yoğurma Makinesi 50 kg 380 V Spiral Dough Mixer 50 kg 380 V	544x912x1065	208	0.53	20	50
ASH.03	Spiral Hamur Yoğurma Makinesi 60 kg 380 V Spiral Dough Mixer 60 kg 380 V	637x1040x1105	240	0.73	35	60

TEKNİK ÖZELLİKLER

- İki hızlı çalışabilen hamur karıştırma kolu.
- Zaman ayarlı kontrol panosu.
- Acil stop.
- Paslanmaz çelik hamur karıştırma kolu ve kazan.
- Kapak açıldığında otomatik durduran switch özelliği.
- Her türlü hamuru yoğurma özelliği.

SH.01

- 1.0 - 1.7 kW 750/1500 D/Dk 380V motor gücü.
- Kazan ebatları: 400x260 mm

SH.02

- 1.5 - 2.5 kW 750/1500 D/Dk 380V motor gücü.
- Kazan ebatları: 500x300 mm

SH.03

- 1.5 - 2.5 kW 750/1500 D/Dk 380V motor gücü.
- Kazan ebatları: 600x315 mm

TECHNICAL SPECIFICATIONS

- Two speed dough mixer arm.
- Control panel with adjustable timer .
- Emergency stop.
- Stainless steel bowl and dough mixer arm.
- Automatic stopper switch feature when the cover is opened.
- Ideal machine for kneading all kinds of dough.

SH.01

- Motor power: 1.0 - 1.7 kW - 750/1500 rpm 380V
- Bowl size: 400x260 mm

SH.02

- Motor power: 1.5 - 2.5 kW - 750/1500 rpm 380V
- Bowl size: 500x300 mm

SH.03

- Motor power: 1.5 - 2.5 kW - 750/1500 rpm 380V
- Bowl size: 600x315 mm



Hazırlık Ekipmanları
Preparation EquipmentTek Devirli Spiral Hamur Yoğurma Makineleri (Tekerlekli)
Mono Speed Spiral Dough Mixer (with Wheels)

andora

Kapaklı
with LidTekerlekli
with Wheels

Kod Code	Ürün Adı Description	Ebatlar Dimension	Ağırlık Weight	Net Net	Un Kap. Flour Cap.	Kapasite Capacity
		a x b x c (mm)	(kg)	(m ³)	(kg)	(lt)
ASH.04	Spiral Hamur Yoğurma Makinesi 15 kg 380 V Spiral Dough Mixer 15 kg 380 V	433x756x933	160	0.31	7	15
ASH.05	Spiral Hamur Yoğurma Makinesi 30 kg 380 V Spiral Dough Mixer 30 kg 380 V	433x790x990	174	0.34	12	30
ASH.06	Spiral Hamur Yoğurma Makinesi 50 kg 380 V Spiral Dough Mixer 50 kg 380 V	544x911x1065	202	0.53	20	50

TEKNİK ÖZELLİKLER

- Zaman ayarlı kontrol panosu.
- Acil stop.
- Paslanmaz çelik hamur karıştırma kolu ve kazan.
- Kapak açıldığında otomatik durduran switch özelliği.

ASH.04

- 1.1 kW 900 D/Dk 380V motor gücü.
- Kazan ebatları: 360x210 mm

ASH.05

- 1.5 kW 900 D/Dk 380V motor gücü.
- Kazan ebatları: 400x260 mm

ASH.06

- 1.5 kW 900 D/Dk 380V motor gücü.
- Kazan ebatları: 500x300 mm

TECHNICAL SPECIFICATIONS

- Control Panel with adjustable timer.
- Emergency stop.
- Stainless steel bowl and dough mixer arm.
- Automatic stopper switch feature when the cover is opened.

ASH.04

- Motor power: 1.1 kW 900 rpm 380V
- Bowl size: 360x210 mm

ASH.05

- Motor power: 1.5 kW 900 rpm 380V
- Bowl size: 400x260 mm

ASH.06

- Motor power: 1.5 kW 900 rpm 380V
- Bowl size: 500x300 mm



Pizza hamuru yoğurmak için kullanılır. Sert hamurların yoğurulması için kullanılmaz.
Operates in purpose of kneading pizza dough. Not advised to use kneading hard dough.



Kod Code	Ürün Adı Description	Ebatlar Dimension	Ağırlık Weight	Net Net	Merdane Ölçüleri Roller Dimensions
		a x b x c (mm)	(kg)	(m ³)	(mm)
AND.HA.01	Hamur Açma Makinesi 40 cm Dough Roller Machine 40 cm	530x493x683	41	0.18	400
AND.HA.02	Hamur Açma Makinesi 30 cm Dough Roller Machine 30 cm	430x493x679	37	0.14	300



Kod Code	Ürün Adı Description	Ebatlar Dimension	Ağırlık Weight	Net Net	Merdane Ölçüleri Roller Dimensions
		a x b x c (mm)	(kg)	(m ³)	(mm)
AND.HA.01.Y	Hamur Açma Makinesi 40 cm Dough Roller Machine 40 cm	530x493x754	41	0.19	400
AND.HA.02.Y	Hamur Açma Makinesi 30 cm Dough Roller Machine 30 cm	430x493x710	37	0.15	300

TEKNİK ÖZELLİKLER

- 0.25 kW - 1500 D/Dk-220V motor gücü.
- Hamur kalınlığı ve çapını ayarlayabilme özelliği.
- Pleksiglas koruma kapağı.
- Derlin Merdane.
- Acil stop.
- Paslanmaz çelik gövde.

TECHNICAL SPECIFICATIONS

- Motor power:0.25 kW - 1500 rpm-220V
- Adjustable dough diameter and thickness.
- Plexiglass protection cover.
- Derlin Roller.
- Emergency stop.
- Stainless steel body.

Hazırlık Ekipmanları
Preparation Equipment**Hamur Açma Makineleri**
Dough Roller Machines

andora



Kod Code	Ürün Adı Description	Ebatlar Dimension	Ağırlık Weight	Net Net	Merdane Ölçüleri Roller Dimensions
		a x b x c (mm)	(kg)	(m ³)	(mm)
AND.HA.04	Tek Merdane Hamur Açma Makinesi 40 cm Single Roller Dough Machine 40 cm	542x396x366	24	0.07	400
AND.HA.05	Tek Merdane Hamur Açma Makinesi 30 cm Single Roller Dough Machine 30 cm	442x396x366	21	0.07	300



Kod Code	Ürün Adı Description	Ebatlar Dimension	Ağırlık Weight	Net Net	Merdane Ölçüleri Roller Dimensions
		a x b x c (mm)	(kg)	(m ³)	(mm)
AND.HA.03	Hamur Açma Makinesi 55 cm Dough Roller 55 cm	940x600x540	58	0.29	550

TEKNİK ÖZELLİKLER

- Hamur kalınlığı ve çapını ayarlayabilme özelliği.
- Derlin Merdane.
- Acil stop.
- Paslanmaz çelik gövde.
- Setüstü çalışabilme özelliği.

AND.HA.04 / AND.HA.05

- 0.18 kW 1500 D/Dk 220V motor gücü.

AND.HA.03

- 0.75 kW - 1400 D/Dk-220V motor gücü.

TECHNICAL SPECIFICATIONS

- Adjustable dough diameter and thickness.
- Derlin Roller.
- Emergency stop.
- Stainless steel body.
- Counter top usage.

AND.HA.04 / AND.HA.05

- Motor power: 0.18 kW - 1500 rpm-220V

AND.HA.03

- Motor power: 0.75 kW - 1400 rpm-220V



Kod Code	Ürün Adı Description	Ebatlar Dimension	Ağırlık Weight	Net Net	Güç Power
		a x b x c (mm)	(kg)	(m ³)	(kw)
AND.HKT.01	Hamur Kestart Makinesi Dough Weighing Machine	475x820x790	90	0.31	0.46
AND.HKT.02	Hamur Kestart Makinesi Alt Standı Dough Weighing Machine	695x860x1000	55	0.60	
AND.HKT.03	Hamur Beze Makinesi Dough Meringue Machine	430x655x805	55	0.23	0.37

TEKNİK ÖZELLİKLER

- Pizza ve roll hamur kesme ve yuvarlama özelliği.
- Paslanmaz çelik gövde.
- Bunker kapasitesi: 44 Lt.
- Çalışma aralığı: 50/300 gr.
- Kapasite: 400 kg/saat.
- Yeni nesil bölme sistemi.
- Yuvarlak, pürüzsüz, kompakt hamur topları.
- Yüksek ölçekleme doğruluğu tolerans +/- % 5
- Kapasite saatte 800-1200 hamur topu.

TECHNICAL SPECIFICATIONS

- Pizza and roll dough cutting and rolling feature.
- Stainless steel body.
- Bunker capacity: 44 Lt.
- Working range: 50/300 gr.
- Capacity: 400 kg/hour.
- New generation partition system.
- Round, Smooth, Compact dough balls.
- High scaling accuracy tolerance +/- % 5
- Capacity 800-1200 dough balls / per hour.



AND.HKT.01



AND.HKT.02



AND.HKT.03

Hazırlık Ekipmanları
Preparation EquipmentÜç Hızlı Mikserler
3 Speed Mixers

andora



Mikserler Hamur Yoğurma İçin Uygun Değildir.
Mixers are not Suitable for Dough Kneading.

Kod Code	Ürün Adı Description	Ebatlar Dimension	Ağırlık Weight	Net Net	Kazan Ebatları Bowl Size	Kapasite Capacity
		a x b x c (mm)	(kg)	(m ³)	(mm)	(lt)
AMK.08	3 Hızlı Mikser 3 Speed Mixer	680x860x1380	183	0.86	360x360	30
AMK.04	3 Hızlı Mikser 3 Speed Mixer	680x880x1400	194	0.85	400x400	40
AMK.06	3 Hızlı Mikser 3 Speed Mixer	680x905x1425	198	0.89	430x460	60

TEKNİK ÖZELLİKLER

- 1.1/1.5/1.85 kW 950/1450/2850 D/Dk 380V motor gücü.
- Üç hızlı çalıştırma özelliği.
- 2 adet çırpma teli.
- 1 adet hamur baltası.
- 1 adet çırpma paleti.
- Zaman ayarlı kontrol panosu.
- Paslanmaz çelik kazan.
- Paslanmaz çelik kazan ve karıştırıcı aparatlar.
- Sarsıntısız ve gürültüsüz çalışma özelliği.
- Switch kontrollü koruma kafesi.

TECHNICAL SPECIFICATIONS

- Motor power: 1.1/1.5/1.85 kW 950/1450/2850 rpm 380V
- Three speed operating feature.
- 2 pieces whisks.
- 1 piece dough hook.
- 1 piece mixing paddle
- Control Panel with adjustable timer.
- Stainless steel bowl.
- Stainless steel bowl and mixing apparatuses.
- Silent and without vibration working feature.
- Switch controlled protection cage.

**Karıştırıcı Aparatlar / Mixing Apparatus**Çırpma Teli
WhiskHamur Baltası
Dough HookÇırpma Paleti
Mixing Paddle



Mikserler Hamur Yoğurma için Uygun Değildir.
Mixers are not Suitable for Dough Kneading.

Kod Code	Ürün Adı Description	Ebatlar Dimension	Ağırlık Weight	Net Net	Kazan Ebatları Bowl Size	Kapasite Capacity
		a x b x c (mm)	(kg)	(m ³)	(mm)	(lt)
AMK.07	Hız Kontrollü Mikser Speed Controlled Mixer	680x860x1380	183	0.86	360x360	30
AMK.03	Hız Kontrollü Mikser Speed Controlled Mixer	680x880x1400	194	0.85	400x400	40
AMK.05	Hız Kontrollü Mikser Speed Controlled Mixer	680x905x1425	198	0.89	430x460	60
AND.10	Hız Kontrollü Mikser Speed Controlled Mixer	410x535x720	52	0.19	260x200	10

TEKNİK ÖZELLİKLER

- Hız kontrollü çalışma özelliği.
- 2 adet çırpma teli.
- 1 adet hamur baltası.
- 1 adet çırpma paleti.
- Hız kontrollü zaman ayarlı kontrol panosu.
- Paslanmaz çelik kazan.
- Paslanmaz çelik kazan ve karıştırıcı aparatlar.
- Sarsıntısız ve gürültüsüz çalışma özelliği.
- Switch kontrollü koruma kafesi.

AMK.03 / AMK.05

- 2.2 kW 1400 D/Dk 220V motor gücü.

AMK.07

- 1.5 kW 1400 D/Dk 220 V motor gücü.

AND.10

- 0,55 kW 1400 D/Dk-220V motor gücü.

TECHNICAL SPECIFICATIONS

- Speed controlled operating option.
- 2 pieces whisks.
- 1 piece dough hook.
- 1 piece mixing paddle.
- Speed controlled timer control panel.
- Stainless steel bowl.
- Stainless steel bowl and mixing apparatuses.
- Silent and without vibration working feature.
- Switch controlled protection cage.

AMK.03 / AMK.05

- Motor power:2.2 kW 1400 rpm 220V

AMK.07

- Motor power:1.5 kW 1400 rpm 220V

AND.10

- Motor Power: 0.55 kW 1400 rpm 220V



Karıştırıcı Aparatlar / Mixing Apparatus



Çırpma Teli
Whisk



Hamur Baltası
Dough Hook



Çırpma Paleti
Mixing Paddle

Hazırlık Ekipmanları
Preparation Equipment**Paslanmaz Et Kıyma Makineleri**
Stainless Steel Meat Mincers

andora



Kod Code	Ürün Adı Description	Ebatlar Dimension	Ağırlık Weight	Net Net	Kapasite Capacity
		a x b x c (mm)	(kg)	(m ³)	(kg/saat-kg/hour)
AND.12.01.P	Et Kıyma Makinesi No:12 220V Meat Mincer No:12 220V	530x245x380	25	0.05	125
AND.12.02.P	Et Kıyma Makinesi No:12 380V Meat Mincer No:12 380V	530x245x380	25	0.05	125
AND.22.01.P	Et Kıyma Makinesi No:22 220V Meat Mincer No:22 220V	590x400x245	29	0.05	200
AND.22.02.P	Et Kıyma Makinesi No:22 380V Meat Mincer No:22 380V	590x400x245	29	0.05	200

TEKNİK ÖZELLİKLER

- Paslanmaz çelik helezon, boğaz ve boğaz somunu.
- Kolay sökülebilir et haznesi ile kolay temizlik imkanı.
- El koruma ünitesi ile güvenli çalışma imkanı.
- Paslanmaz çelik gövde.
- Dünya standardı ayna ve bıçak kullanımı.

AND.12.01.P / AND.12.02.P

- 0.55 kW 1400 D/Dk - 220 V / 380V motor gücü.

AND.22.01.P / AND.22.02.P

- 0.75 kW 1400 D/Dk - 220V / 380V motor gücü.

TECHNICAL SPECIFICATIONS

- Stainless steel handwheel and spiral.
- Easy removable handwheel and easy cleaning.
- Hand protection provides safe operation.
- Stainless steel body.
- Mirror plate and blade as per international standards.

AND.12.01.P / AND.12.02.P

- Motor Power:0.55 kW 1400 rpm - 220V / 380V

AND.22.01.P / AND.22.02.P

- Motor Power: 0.75 kW 1400 rpm - 220V / 380V



Kovan helezon, somun grubu paslanmaz çeliktir.
Gear housing, spiral, nut group are stainless steel.



Kod Code	Ürün Adı Description	Ebatlar Dimension	Ağırlık Weight	Net Net	Kapasite Capacity
		a x b x c (mm)	(kg)	(m ³)	(kg/saat-kg/hour)
AN.01.P	Et Kıyma Makinesi No:32 220V Meat Mincer No:32 220V	820x360x410	53	0.12	600
AN.02.P	Et Kıyma Makinesi No:32 380V Meat Mincer No:32 380V	820x360x410	53	0.12	600
AN.09.P	Et Kıyma Makinesi No:22 220V Meat Mincer No:22 220V	775x320x410	46	0.10	400
AN.10.P	Et Kıyma Makinesi No:22 380V Meat Mincer No:22 380V	775x320x410	46	0.10	400

TEKNİK ÖZELLİKLER

- Paslanmaz çelik helezon, boğaz ve boğaz somunu.
- Kolay sökülebilir et haznesi ile kolay temizlik imkanı.
- El koruma ünitesi ile güvenli çalışma imkanı.
- Paslanmaz çelik gövde.
- Dünya standardı ayna ve bıçak kullanımı.

AN.01.P / AN.02.P

- 2.2 kW 1400 D/Dk 220V / 380V motor gücü.

AN.09.P / AN.10.P

- 1.5 kW 1400 D/Dk 220V / 380V motor gücü.

TECHNICAL SPECIFICATIONS

- Stainless steel handwheel and spiral.
- Easy removable handwheel and easy cleaning.
- Hand protection provides safe operation.
- Stainless steel body.
- Mirror plate and blade as per international standards.

AN.01.P / AN.02.P

- Motor Power: 2.2 kW 1400 rpm 220V / 380V

AN.09.P / AN.10.P

- Motor Power: 1.5 kW 1400 rpm 220V / 380V



Kovan helezon, somun grubu paslanmaz çeliktir.
Gear housing, spiral, nut group are stainless steel.

Hazırlık Ekipmanları
Preparation EquipmentPaslanmaz Soğutmalı Et Kıyma Makineleri
Stainless Steel Refrigerated Meat Mincers

andora

CE

SOĞUTMALI
REFRIGERATED

Kod Code	Ürün Adı Description	Ebatlar Dimension	Ağırlık Weight	Net Net	Kapasite Capacity
		a x b x c (mm)	(kg)	(m ³)	(kg/saat-kg/hour)
AN.07	Soğutmalı Et Kıyma Makinesi No:32 220V Refrigerated Meat Mincer No:32 220V	830x360x520	70	0.16	700
AN.08	Soğutmalı Et Kıyma Makinesi No:32 380V Refrigerated Meat Mincer No:32 380V	830x360x520	70	0.16	700

TEKNİK ÖZELLİKLER

- Paslanmaz çelik helezon, boğaz ve boğaz somunu.
- Et haznesi soğutma özelliği.
- Dijital kontrollü soğutma ünitesi.
- El koruma ünitesi ile güvenli çalışma imkanı.
- Paslanmaz çelik gövde.
- Kolay sökülebilir boğaz haznesi ile kolay temizlik imkanı.
- Dünya standardı ayna ve bıçak kullanımı.

AN.07

- 2.2 kW 1400 D/Dk 220V motor gücü.

AN.08

- 2.2 kW 1400 D/Dk 380V motor gücü.

TECHNICAL SPECIFICATIONS

- Motor Power: 2.2 kW 1400 rpm-220V / 380V
- Stainless steel handwheel and spiral.
- Refrigerated neck.
- Cooling system with digital control.
- Hand protection provides safe operation.
- Stainless steel body.
- Easy removable handwell and easy cleaning.
- Mirror plate and blade as per international standards.

AN.07

- Motor Power: 2.2 kW 1400 rpm 220V

AN.08

- Motor Power:1.5 kW 1400 rpm 380V



Kovan helezon, somun grubu paslanmaz çeliktir.
Gear housing, spiral, nut group are stainless steel.



SOĞUTMALI
REFRIGERATED

Kod Code	Ürün Adı Description	Ebatlar Dimension	Ağırlık Weight	Net Net	Kapasite Capacity
		a x b x c (mm)	(kg)	(m ³)	(kg/saat-kg/hour)
AN.22.09	Plus Et Kıyma Makinesi No:22 220V Plus Meat Mincer No:22 220V	510x340x565	42	0.9	400
AN.22.10	Plus Et Kıyma Makinesi No:22 380V Plus Meat Mincer No:22 380V	510x340x565	42	0.9	400
AN.32.09	Plus Et Kıyma Makinesi No:32 220V Plus Meat Mincer No:32 220V	650x350x580	48	0.13	600
AN.32.10	Plus Et Kıyma Makinesi No:32 380V Plus Meat Mincer No:32 380V	650x350x580	48	0.13	600

Kod Code	Ürün Adı Description	Ebatlar Dimension	Ağırlık Weight	Net Net	Kapasite Capacity
		a x b x c (mm)	(kg)	(m ³)	(kg/saat-kg/hour)
AN.22.09-S	Soğutmalı Plus Et Kıyma Makinesi No:22 220V Plus Refrigerated Meat Mincer No:22 220V	560x350x630	55	0.12	400
AN.22.10-S	Soğutmalı Plus Et Kıyma Makinesi No:22 380V Plus Refrigerated Meat Mincer No:22 380V	560x350x630	55	0.12	400
AN.32.09-S	Soğutmalı Plus Et Kıyma Makinesi No:32 220V Plus Refrigerated Meat Mincer No:32 220V	630x360x565	56	0.13	600
AN.32.10-S	Soğutmalı Plus Et Kıyma Makinesi No:32 380V Plus Refrigerated Meat Mincer No:32 380V	630x360x565	56	0.13	600

TEKNİK ÖZELLİKLER

- Şeffaf üst koruma kapağı.
- Paslanmaz çelik helezon, boğaz ve boğaz somunu.
- Dijital kontrollü soğutma ünitesi.
- El koruma ünitesi ile güvenli çalışma imkanı.
- Acil stop.
- Paslanmaz çelik gövde.
- Dünya standardı ayna ve bıçak kullanımı.

AN.22.09 / AN.22.10

- 1.5 kw 1400 D/Dk 220V / 380V motor gücü.

AN.32.09 / AN.32.10

- 2.2 kw 1400 D/Dk 220V / 380V motor gücü.

AN.22.09-S / AN.22.10-S

- 1.5 kw 1400 D/Dk-220V / 380V motor gücü.

AN.32.09-S / AN.32.10-S

- 2.2 kW 1400 D/Dk-220V / 380V motor gücü.

TECHNICAL SPECIFICATIONS

- Transparent top protection cover.
- Stainless steel handwheel and spiral.
- Cooling system with digital control.
- Hand protection provides safe operation.
- Emergency stop.
- Stainless steel body.
- Mirror plate and blade as per international standards.

AN.22.09 / AN.22.10

- Motor Power: 1.5 kw 1400 rpm 220V / 380V

AN.32.09 / AN.32.10

- Motor Power: 2.2 kw 1400 rpm 220V / 380V

AN.22.09-S / AN.22.10-S

- Motor Power: 1.5 kW 1400 rpm-220V / 380V

AN.32.09-S / AN.32.10-S

- Motor Power: 2.2 kW 1400 rpm-220V / 380V



Kovan helezon, somun grubu paslanmaz çeliktir.
Gear housing, spiral, nut group are stainless steel.

Hazırlık Ekipmanları
Preparation EquipmentEt ve Kemik Testereleri
Anodized Bone Saws

andora



Kod Code	Ürün Adı Description	Ebatlar Dimension	Ağırlık Weight	Net Net
		a x b x c (mm)	(kg)	(m ³)
AND.ETK.01	Et ve Kemik Testeresi Anodized Bone Saw	545x590x900	45	0.30
AND.ETK.02	Et ve Kemik Testeresi Alt Standlı Anodized Bone Saw With Stand	550x670x1540	75	0.56

TEKNİK ÖZELLİKLER

- Paslanmaz çelik çalışma yüzeyi ve bıçak.
- Kolay ayarlanabilir ürün dayama kolu.
- Donmuş veya taze kemikli, kemiksiz et kesme testeresi.
- Acil stop.

AND.ETK.01

- 0.75 kW 900 d / dk 220V. motor gücü.
- 1815 mm bant uzunluğu.
- 290 mm kesme yüksekliği.
- 195 mm kesme genişliği.
- 380x545 mm çalışma tezgahı

AND.ETK.02

- 1.5 kW 1400 d / dk 220V motor gücü.
- 2145 mm bant uzunluğu.
- 350 mm kesme yüksekliği.
- 230 mm kesme genişliği.
- 465x545 mm çalışma tezgahı

TECHNICAL SPECIFICATIONS

- Stainless steel working surface and blade.
- Easy adjustable meat holding arm.
- Frozen and fresh boned, boneless and cutting saw.
- Emergency stop.

AND.ETK.01

- Motor power: 0.75 kW 900 rpm 220V
- Band length: 1815 mm
- Usable cut height: 290 mm
- Usable cut depth: 195 mm
- Working table: 380x545 mm

AND.ETK.02

- Motor power: 1.5 kW 1400 rpm 220V
- Band length: 2145 mm
- Usable cut height: 350 mm
- Usable cut depth: 230 mm
- Working table: 465x545 mm



AND.ETK.01



AND.ETK.02



Kod Code	Ürün Adı Description	Ebatlar Dimension	Ağırlık Weight	Net Net	Kapasite Capacity
		a x b x c (mm)	(kg)	(m³)	(kg)
APS.05	Patates Soyma Makinesi 220V Potato Peeler Machine 220V	540x760x965	42	0.35	10
APS.06	Patates Soyma Makinesi 380V Potato Peeler Machine 380V	540x760x965	42	0.35	10
APS.07	Patates Soyma Makinesi 220V Potato Peeler Machine 220V	600x870x1065	53	0.52	20
APS.08	Patates Soyma Makinesi 380V Potato Peeler Machine 380V	600x870x1065	53	0.52	20
APS.09	Patates Soyma Makinesi 220V Potato Peeler Machine 220V	600x870x1160	58	0.57	30
APS.10	Patates Soyma Makinesi 380V Potato Peeler Machine 380V	600x870x1160	58	0.57	30

TEKNİK ÖZELLİKLER

- Zaman ayarlı kontrol panosu.
- Ayarlanan süre bitiminde otomatik durma sistemi.
- 1-2 dk patates soyma süresi.
- Paslanmaz çelik gövde.
- Silisyum karbür (zımpara taşı) ile kaplanmış uzun ömürlü soyma yüzeyleri.
- Ön kapaktan boşaltma sistemi.
- Switch kontrollü, kapak açıldığında otomatik durma sistemi.

APS.05 / APS.06

- 0.55 kW 900 D/Dk - 220V / 380V motor gücü.
- 400x380 mm paslanmaz çelik soyma haznesi.

APS.07 / APS.08

- 0.75 kW 900 D/Dk - 220V / 380V motor gücü.
- 500x400 mm paslanmaz çelik soyma haznesi.

APS.09

- 1.5 kW 900 D/Dk - 220V
- 500x500 mm paslanmaz çelik soyma haznesi.

APS.10

- 1.1 kW 900 D/Dk- 380V
- 500x500 mm paslanmaz çelik soyma haznesi.

TECHNICAL SPECIFICATIONS

- Equipped with timer and control panel.
- Machine stops once setted operation is completed.
- Peeling time: 1-2 minute.
- Stainless steel body.
- Long lasting abrasive surface covered with silicium carbide.
- Discharge from front door.
- Product stop operating once the cover is open, as it has magnetic switch.

APS.05 / APS.06

- Motor Power: 0.55 kW 900 rpm - 220V / 380V
- Stainless steel housing dimension: 400x380 mm

APS.07 / APS.08

- Motor Power: 0.75 kW 900 rpm - 220V / 380V
- Stainless steel housing dimension: 500x400 mm

APS.09

- 1.5 kW 900 rpm 220V
- Stainless steel housing dimension: 500x500 mm

APS.10

- 1.1 kW 900 rpm 380V
- Stainless steel housing dimension: 500x500 mm



Hazırlık Ekipmanları
Preparation EquipmentFiltreli Patates Soyma Makineleri
Filtred Potato Peeler Machines

andora



Kod Code	Ürün Adı Description	Ebatlar Dimension	Ağırlık Weight	Net Net	Kapasite Capacity
		a x b x c (mm)	(kg)	(m ³)	(kg)
APS.05-F	Filtreli Patates Soyma Makinesi 220V Filtred Potato Peeler Machine 220V	490x780x1210	55	0.43	10
APS.06-F	Filtreli Patates Soyma Makinesi 380V Filtred Potato Peeler Machine 380V	490x780x1210	55	0.43	10
APS.07-F	Filtreli Patates Soyma Makinesi 220V Filtred Potato Peeler Machine 220V	590x880x1310	75	0.64	20
APS.08-F	Filtreli Patates Soyma Makinesi 380V Filtred Potato Peeler Machine 380V	590x880x1310	75	0.64	20
APS.09-F	Filtreli Patates Soyma Makinesi 220V Filtred Potato Peeler Machine 220V	590x880x1400	80	0.69	30
APS.10-F	Filtreli Patates Soyma Makinesi 380V Filtred Potato Peeler Machine 380V	590x880x1400	80	0.69	30

TEKNİK ÖZELLİKLER

- Zaman ayarlı kontrol panosu.
- Ayarlanan süre bitiminde otomatik durma sistemi.
- 1-2 dk patates soyma süresi.
- Paslanmaz çelik gövde.
- Silisyum karbür (zımpara taşı) ile kaplanmış uzun ömürlü soyma yüzeyleri.
- Ön kapaktan boşaltma sistemi.
- Switch kontrollü, kapak açıldığında otomatik durma sistemi.

APS.05-F / APS.06-F

- 0.55 kW 900 D/Dk - 220V / 380V motor gücü.
- 400x380 mm paslanmaz çelik soyma haznesi.

APS.07-F / APS.08-F

- 0.75 kW 900 D/Dk - 220V / 380V motor gücü.
- 500x400 mm paslanmaz çelik soyma haznesi.

APS.09-F

- 1.5 kW 900 D/Dk - 220V
- 500x500 mm paslanmaz çelik soyma haznesi.

APS.10-F

- 1.1 kW 900 D/Dk - 380V
- 500x500 mm paslanmaz çelik soyma haznesi.

TECHNICAL SPECIFICATIONS

- Equipped with timer and control panel.
- Machine stops once setted operation is completed.
- Peeling time: 1-2 minute.
- Stainless steel body.
- Long lasting abrassive surface covered with silicium carbide.
- Discharge from front door.
- Product stop operating once the cover is open, as it has magnetic switch.

APS.05-F / APS.06-F

- Motor Power: 0.55 kW 900 rpm - 220V / 380V
- Stainless steel housing dimension: 400x380 mm

APS.07-F / APS.08-F

- Motor Power: 0.75 kW 900 rpm-220V / 380V
- Stainless steel housing dimension: 500x400 mm

APS.09-F

- 1.5 kW 900 rpm 220V
- Stainless steel housing dimension: 500x500 mm

APS.10-F

- 1.1 kW 900 rpm 380V
- Stainless steel housing dimension: 500x500 mm





Kod Code	Ürün Adı Description	Ebatlar Dimension	Ağırlık Weight	Net Net
		a x b x c (mm)	(kg)	(m ³)
AND.SYK.01	Sebze Yıkama ve Kurutma Makinesi Vegetable Washing and Dryer Machine	1300x660x987	137	0.85

TEKNİK ÖZELLİKLER

- 4/20 Kg/Saat yıkama kapasitesi.
- 4/10 Dk. yıkama süresi.
- 2/10 Kg Kurutma kapasitesi.
- 2/4 Dk Kurutma süresi.
- 157 Litre yıkama tank kapasitesi.
- 0.37-0.50 kW 1000 D/Dk 380V
- Paslanmaz çelik gövde ve kazan.
- Su basınç ayar kontrolü.
- Özel yıkama sistemi için oluşturulmuş tankta su hareketiyle yıkanan sebze ve meyvelerin kir ve atıkları çökertme haznesine biriktirilerek tahliye edilmesi yoluyla yıkanır.
- Yıkama kazanı kolay temizlenebilir, çökertme haznesi kolay sökülebilir ve taşma tahliye sistemlidir.

TECHNICAL SPECIFICATIONS

- 4/20 Kg/Hour Washing capacity.
- 4/10 Min. Washing time.
- 2/10 Kg drying capacity.
- 2/10 Min. drying time.
- 157 Liter Washing tank capacity.
- 0.37 - 0.50 kW 1000 rpm 380V
- Stainless steel body and tank.
- Adjustable water pressure.
- The dirty and waste of vegetables and fruits washed by the movement of water in the washing system tank, are collected in the sedimentation chamber, and washing is performed by discharging.
- Washing tank and the coating materials are made of stainless steel.



Hazırlık Ekipmanları
Preparation EquipmentSebze ve Salata Kurutma Makineleri
Salad and Vegetable Dryers

andora



Kod Code	Ürün Adı Description	Ebatlar Dimension	Ağırlık Weight	Net Net	Kapasite Capacity
		a x b x c (mm)	(kg)	(m ³)	(lt)
ASY.40-09	Sebze ve Salata Kurutma Makinesi 220V Salad and Vegetable Dryer 220V	590x780x1065	50	0.45	40
ASY.40-10	Sebze ve Salata Kurutma Makinesi 380V Salad and Vegetable Dryer 380V	590x780x1065	50	0.45	40
ASY.60-09	Sebze ve Salata Kurutma Makinesi 220V Salad and Vegetable Dryer 220V	590x780x1150	53	0.49	60
ASY.60-10	Sebze ve Salata Kurutma Makinesi 380V Salad and Vegetable Dryer 380V	590x780x1150	53	0.49	60

TEKNİK ÖZELLİKLER

- Sebze ve Salata doğal tazeliğinde kısa sürede kurutulmasını sağlar.
- Zaman ayarlı kontrol panosu.
- Paslanmaz çelik gövde.
- Switch kontrollü, makine kapağı açıldığında otomatik durma sistemi.

ASY.40-09 / ASY.60-09

- 0.55-0.75 kW 1500 D/Dk 220V motor gücü.

ASY.40-10 / ASY.60-10

- 0.55-0.75 kW 1500 D/Dk 380V motor gücü.

TECHNICAL SPECIFICATIONS

- Operates in order to dry vegetables in short time.
- Control panel with timer.
- Stainless steel body.
- Dryer stops operating once the lid is open, as it has magnetic switch.

ASY.40-09 / ASY.60-09

- Motor Power: 0.55-0.75 kW 1500 rpm 220V

ASY.40-10 / ASY.60-10

- Motor Power: 0.55-0.75 kW 1500 rpm 380V

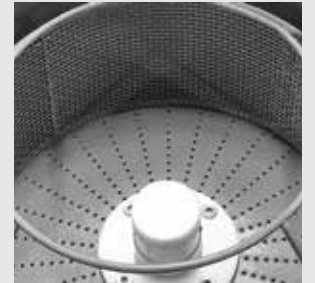



CE

Kod Code	Ürün Adı Description	Ebatlar Dimension	Ağırlık Weight	Net Net	Kapasite Capacity
		a x b x c (mm)	(kg)	(m ³)	(kg)
AND.TK.001	Tulumba Tatlı Şekillendirme Makinesi Semolina Dessert Preparation Machine	695x360x970	49	0.13	5



Kod Code	Ürün Adı Description	Ebatlar Dimension	Ağırlık Weight	Net Net
		a x b x c (mm)	(kg)	(m ³)
AND.LK.001	Saray ve İzmir Lokma Makinesi 220V Doughnut Machine 220V	830x410x590	32	0.17
AND.LK.004	Saray ve İzmir Lokma Makinesi Standı Doughnut Machine Stand	750x800x840	12	0.50

TEKNİK ÖZELLİKLER

- 220V - 50 Hz Enerji.
- 7 kg hamur hazne kapasitesi.

TECHNICAL SPECIFICATIONS

- 220V - 50 Hz Energy.
- Dough capacity: 7 kg



AND.LK.004
Saray ve İzmir Lokma Makinesi Standı
Doughnut Machine Stand

Hazırlık Ekipmanları
Preparation EquipmentLokma ve Tulumba Tatlı Makine Tezgahları
Doughnut and Tulumba Dessert Machine Tables

andora



Kod Code	Ürün Adı Description	Ebatlar Dimension	Ağırlık Weight	Net Net
		a x b x c (mm)	(kg)	(m ³)
AND.LK.002	Saray ve İzmir Lokma Makine Tezgahı Lpg-Ng Doughnut Machine Table Lpg-Ng	1400x700x850/1320	75	1.30
AND.LK.003	Saray ve İzmir Lokma Makine Tezgahı Elektrikli 220V Doughnut Machine Table Electrical 220V	1400x700x850/1320	75	1.30



Kod Code	Ürün Adı Description	Ebatlar Dimension	Ağırlık Weight	Net Net
		a x b x c (mm)	(kg)	(m ³)
AND.LK.006	Saray ve İzmir Lokma Makinesi Tezgahı Lpg-Ng Doughnut Machine Table Lpg-Ng	2200x700x850/1320	105	2
AND.LK.007	Saray ve İzmir Lokma Makinesi Tezgahı Elektrikli 220V Doughnut Machine Table Electrical 220V	2200x750x850/1320	105	2

TEKNİK ÖZELLİKLER

- Kilitlenebilir tekerlekler.
- Paslanmaz çelik gövde.
- Saray Lokma Makinesi dakikada 300 adet.
- İzmir Lokma Makinesi dakikada 48 adet.

AND.LK.002 - AND.LK.003

- 25 lt pişirme kazanı.
- 2x1/1 Gn kuvvetli.

AND.LK.006 - AND.LK.007

- 25+25 lt pişirme kazanı.
- 2x1/1 Gn kuvvetli.

TECHNICAL SPECIFICATIONS

- Lockable castors.
- Stainless steel body.
- 300 pieces of doughnut per a minute.
- 48 pieces of doughnut per a minute.

AND.LK.002 - AND.LK.003

- Cooking bowl capacity: 25 lt
- 2x1/1 Gn container.

AND.LK.006 - AND.LK.007

- Cooking bowl capacity: 25+25 lt
- 2x1/1 Gn container.



AND.TK.001 + AND.LK.001 + AND.LK.006



Kod Code	Ürün Adı Description	Ebatlar Dimension a x b x c (mm)	Ağırlık Weight (kg)	Net Net (m ³)	Kapasite Capacity (kg)
ATK.01	Otomatik Tulumba ve Köfte Şekillendirme Makinesi 220V Automatic Semolina and Meatball Shapers 220V	1510x450x1040	102	0.69	5
ATK.02	Otomatik Tulumba ve Köfte Şekillendirme Makinesi 380V Automatic Semolina and Meatball Shapers 380V	1510x450x1040	102	0.69	5
ATK.05	Otomatik Tulumba ve Köfte Şekillendirme Makinesi 220V Automatic Semolina and Meatball Shapers 220V	1510x450x1040	104	0.69	10
ATK.06	Otomatik Tulumba ve Köfte Şekillendirme Makinesi 380V Automatic Semolina and Meatball Shapers 380V	1510x450x1040	104	0.69	10

TEKNİK ÖZELLİKLER

- 6-7 dakika şekillendirme süresi.
- 4 farklı uzunlukta şekil verme imkanı.
- Aparat değiştirilerek köfte şekillendirmek için kullanılır.
- Haznesinde hamur bitince otomatik durma sistemi.

ATK.01 / ATK.05

- 0.37 kW-1400 D/Dk 220V motor gücü.

ATK.02 / ATK.06

- 0.37 kW-1400 D/Dk 380V motor gücü.

TECHNICAL SPECIFICATIONS

- Duration of shaping: 6-7 minutes.
- 4 different shaping length option.
- With changing the part, you can use for meat shaping.
- Once the dough or meat inside the tank is finished, machine stops automatically.

ATK.01 / ATK.05

- Motor power: 0.37 kW 1400 rpm-220V

ATK.02 / ATK.06

- 0.37 kW-1400 D/Dk 380V motor gücü.

Hamur Kapasiteleri
 Dough Capacities

5 Kg Hamur Haznesi
 5 Kg Dough Tank

10 Kg Hamur Haznesi
 10 Kg Dough Tank

Hazırlık Ekipmanları
Preparation EquipmentTabak Kapatma Makineleri
Meal Seal Machines

andora



Kod Code	Ürün Adı Description	Ebatlar Dimension	Ağırlık Weight	Net Net	Güç Power
		a x b x c (mm)	(kg)	(m ³)	(kw)
AND.TKM.01	Tabak Kapatma Makinesi Meal Seal Machine	330x655x310	18	0.07	1
AND.TKM.02	Tabak Kapatma Makinesi Türk Kalıplı Meal Seal Machine Turkish Mold	330x655x310	18	0.07	1
AND.TKM.01-CM	Standart Dışı Kalıp Fiyat Farkı Custom Made Mold Price Difference				

TEKNİK ÖZELLİKLER

- 1 kW 220 V elektrik bağlantısı.
- 270x250 mm mühürleme ebadı.
- 200 mm film kalınlığı.
- Maksimum 245 mm film genişliği.
- Paslanmaz çelik gövde.

TECHNICAL SPECIFICATIONS

- 1 kW 220 V electric connection.
- Seal surface: 270x250 mm
- Roll thickness of the film: 200 mm
- Film width: 245 mm max.
- Stainless steel body.

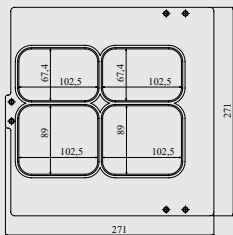
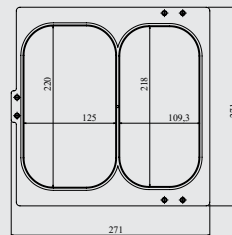
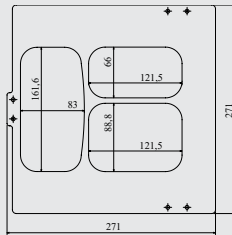
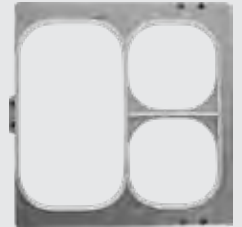
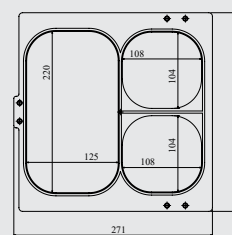
Türk Modeli Kalıp
Turkish MoldStandart Kalıp
Standart Mold

600-720
Bardak/Saat
Glass/Hour300-360
Bardak/Saat
Glass/Hour

Kod Code	Ürün Adı Description	Ebatlar Dimension	Ağırlık Weight	Net Net	Kapasite Capacity
		a x b x c (mm)	(kg)	(m ³)	(bardak/saat - glass/hour)
AND.BPR.001	Bardak Kurutma Makinesi Glass Dryer Machine	355x595x505	27	0.1	600-720
AND.BPR.002	Bardak Kurutma Makinesi Glass Dryer Machine	325x370x505	20	0.06	300-360
Y.AND.BPR.001.1008	Uzun Püskül Long Tassel				
Y.AND.BPR.001.1009	Kısa Püskül Short Tassel				

TEKNİK ÖZELLİKLER

- Sıcak hava kurutma kanalları.
- Paslanmaz çelik gövde.

AND.BPR.001

- 0,37 kW 2800 D/Dk 220V motor gücü.
- 2,62 kW makine toplam gücü.
- 600-720 bardak/saat kapasitesi.
- 8 adet bardak parlatici püskülü.

AND.BPR.002

- 0,37 kW 2800 D/Dk 220V motor gücü.
- 1,49 kW makine toplam gücü.
- 300-360 bardak/saat kapasitesi.
- 5 adet bardak parlatici püskülü.

TECHNICAL SPECIFICATIONS

- Hot air drying.
- Stainless steel body.

AND.BPR.001

- Motor power: 0,37 kW 2800 rpm 220V
- 2,62 kW total power.
- 600-720 glass/hour capacity.
- 8 pieces glass polisher tassels.

AND.BPR.002

- Motor power: 0,37 kW 2800 rpm 220V
- 1,49 kW total power.
- 300-360 glass/hour capacity.
- 5 pieces glass polisher tassels.

**Ürün Detayları / Product Details****AND.BPR.001**

- 6 adet uzun püskül. / 6 pieces long tassel.
- 2 adet kısa püskül. / 2 pieces short tassel.

**AND.BPR.002**

- 4 adet uzun püskül. / 4 pieces long tassel.
- 1 adet kısa püskül. / 1 piece short tassel.

Hazırlık Ekipmanları
Preparation EquipmentÇatal Kaşık Parlatma Makineleri
Cutlery Polisher Machines

andora

CE



Kod Code	Ürün Adı Description	Ebatlar Dimension a x b x c (mm)	Ağırlık Weight (kg)	Net Net (m ³)	Kapasite Capacity (adet/saat-pieces/hour)
AND.CKP.01	Çatal Kaşık Parlatma Makinesi Cutlery Polisher Machine	560x590x431	42	0.14	3000
AND.CKP.02	Çatal Kaşık Parlatma Makinesi Cutlery Polisher Machine	660x650x710	70	0.30	7000

TEKNİK ÖZELLİKLER

- 8 W gücünde ultraviyole ampül.
- Paslanmaz çelik gövde.

AND.CKP.01

- 0.18 kW 1500 D/Dk 220V
- 3 Kg parlatıcı ürün kapasitesi.
- 3000 Adet/Saat parlatma kapasitesi.

AND.CKP.02

- 0.18 kW 1500 D/Dk 220V
- 5 Kg parlatıcı ürün kapasitesi.
- 7000 Adet/Saat parlatma kapasitesi.

TECHNICAL SPECIFICATIONS

- Ultraviolet lamp power: 8 W
- Stainless steel body.

AND.CKP.01

- 0.18 kW 1500 rpm 220V
- 3 Kg tank capacity for polisher material.
- 3000 Piece/Hour polishing capacity.

AND.CKP.02

- 0.18 kW 1500 rpm 220V
- 5 Kg tank capacity for polisher material.
- 7000 Piece/Hour polishing capacity.





Kod Code	Ürün Adı Description	Ebatlar Dimension	Ağırlık Weight	Net Net	Dilim Kalınlığı Slice Thickness
		a x b x c (mm)	(kg)	(m ³)	(mm)
AND.3001-10	Ekmek Dilimleme Makinesi Bread Slicer Machine	717x686x1140	125	0.56	10
AND.3001-13	Ekmek Dilimleme Makinesi Bread Slicer Machine	717x686x1140	125	0.56	13
AND.3001-16	Ekmek Dilimleme Makinesi Bread Slicer Machine	717x686x1140	125	0.56	16
AND.3002	Trabzon Ekmek Dilimleme Makinesi Rye Bread Slicer Machine	717x686x1140	125	0.56	20
AND.3004-10	Setüstü Ekmek Dilimleme Makinesi Bench Top Bread Slicer Machine	733x643x682	86	0.32	10
AND.3004-13	Setüstü Ekmek Dilimleme Makinesi Bench Top Bread Slicer Machine	733x643x682	86	0.32	13
AND.3004-16	Setüstü Ekmek Dilimleme Makinesi Bench Top Bread Slicer Machine	733x643x682	86	0.32	16

TEKNİK ÖZELLİKLER

- 0,37 kW 1400 D/Dk 220V motor gücü.
- Ekmek yüksekliğine göre ayarlanan baskı sistemi.
- Ayar kolu sayesinde ekmeği ezmeden ve parçalamadan keser.
- Kesme işlemi bitiminde makine otomatik olarak kapanır.

AND.3001-10

- 10 mm dilim kalınlığı.
- 46 adet paslanmaz çelik bıçak.

AND.3001-13

- 13 mm dilim kalınlığı.
- 36 adet paslanmaz çelik bıçak.

AND.3001-16

- 16 mm dilim kalınlığı.
- 30 adet paslanmaz çelik bıçak.

AND.3002

- 20 mm dilim kalınlığı.
- 24 adet paslanmaz çelik bıçak.

AND.3004-10

- 10 mm dilim kalınlığı.
- 42 adet paslanmaz çelik bıçak.

AND.3004-13

- 13 mm dilim kalınlığı.
- 30 adet paslanmaz çelik bıçak.

AND.3004-16

- 16 mm dilim kalınlığı.
- 26 adet paslanmaz çelik bıçak.

TECHNICAL SPECIFICATIONS

- Motor Power: 0,37 kW 1400 rpm 220V
- Adjustable press system to height of bread.
- Adjustment arm provide to cut bread without breaking in to piece.
- Automatic turning off after slicing.

AND.3001-10

- 10 mm bread thickness.
- Quantity of stainless steel blades: 46

AND.3001-13

- 13 mm bread thickness.
- Quantity of stainless steel blades: 36

AND.3001-16

- 16 mm bread thickness.
- Quantity of stainless steel blades: 30

AND.3002

- 20 mm bread thickness.
- Quantity of stainless steel blades: 24

AND.3004-10

- 10 mm bread thickness.
- Quantity of stainless steel blades: 42

AND.3004-13

- 13 mm bread thickness.
- Quantity of stainless steel blades: 30

AND.3004-16

- 16 mm bread thickness.
- Quantity of stainless steel blades: 26

Hazırlık Ekipmanları
Preparation Equipment**Ekmek Dilimleme - Simit ve Sandviç Kesme Makineleri**
Baguette Bread Slicer - Pretzel and Sandwich Slicer Machines

andora



Kod Code	Ürün Adı Description	Ebatlar Dimension	Ağırlık Weight	Net Net	Kapasite Capacity
		a x b x c (mm)	(kg)	(m ³)	(dilim/saat - slice/hour)
AND.3003	Baget Ekmek Dilimleme Makinesi Baguette Bread Slicer Machine	390x541x1003	30	0.22	8000

TEKNİK ÖZELLİKLER

- 0,25 kW 1500 D/Dk 220V motor gücü.
- 10-80 mm dilim kalınlığı.
- 8000 dilim/saat kapasitesi.
- Paslanmaz çelik gövde.

TECHNICAL SPECIFICATIONS

- Motor power: 0.25 kW 1500 rpm 220V
- 10-80 mm slice thickness.
- 8000 slice /hour capacity.
- Stainless steel body.



Kod Code	Ürün Adı Description	Ebatlar Dimension	Ağırlık Weight	Net Net
		a x b x c (mm)	(kg)	(m ³)
AND.3005	Simit ve Sandviç Kesme Makinesi Pretzel and Sandwich Slicer	490x300x245	20	0.04

TEKNİK ÖZELLİKLER

- 0,12 kW 220V motor gücü.
- 210 mm kesme uzunluğu.
- 140 mm kesme genişliği.
- 20-55 mm kesme yüksekliği.
- Paslanmaz çelik gövde.

TECHNICAL SPECIFICATIONS

- Motor power: 0.12 kW 220V
- 210 mm slicing length.
- 140 mm slicing width.
- 20-55 mm slicing height.
- Stainless steel body.





Kod Code	Ürün Adı Description	Ebatlar Dimension	Ağırlık Weight	Net Net	Güç Power
		a x b x c (mm)	(kg)	(m ³)	(kw)
AND.SCM.01	Streç Film Makinesi Cling Film Machine	580x435x235	8	0.06	0.17

TEKNİK ÖZELLİKLER

- 220V 50-60 Hz elektrik bağlantısı.
- Hijyenik streç film haznesi.
- 400 mm film boyu.
- Maksimum 90 °C ısıtıcı plaka sıcaklığı.
- Maksimum 150 °C kesici sıcaklığı.
- Paslanmaz çelik gövde.

TECHNICAL SPECIFICATIONS

- 220V 50-60 Hz electric connection.
- Hygienic stretch film container.
- 400 mm film length.
- Maximum 90 °C heating plate temperature.
- Maximum 150 °C cutter temperature.
- Stainless steel body.



Sıvı ürünlerin vakumlanması için uygundur.
 Suitable for the purpose of vacuuming liquids

Kod Code	Ürün Adı Description	Ebatlar Dimension	Ağırlık Weight	Net Net	Güç Power
		a x b x c (mm)	(kg)	(m ³)	(kw)
AND.VCM.01	Vakum Makinesi Vacuum Machine	360x586x433	38	0.09	0.4
AND.VCM.02	Vakum Makinesi Vacuum Machine	550x596x549	62	0.18	0.9

TEKNİK ÖZELLİKLER

- 220V 50 Hz elektrik bağlantısı.
- Şeffaf üst kapak.
- Otomatik kontrol.
- Paslanmaz çelik gövde.

AND.VCM.01

- İç Hazne: 270x350x70 mm
- Yapıştırma Ağız: 250 mm
- 260x8 mm mühürleme ebadı.
- 10 m³/h pompa kapasitesi.

AND.VCM.02

- İç Hazne: 460x360x120 mm
- Yapıştırma Ağız: 430 mm
- 430x8 mm mühürleme ebadı.
- 20 m³/h pompa kapasitesi.

TECHNICAL SPECIFICATIONS

- 220V 50 Hz electric connection.
- Translucent top cover.
- Automatic control.
- Stainless steel body.

AND.VCM.01

- Interior tank: 270x350x70 mm
- Vacuuming Area: 250 mm
- Seal surface: 260x8 mm
- Pump capacity: 10m³/h

AND.VCM.02

- Interior tank: 460x360x120 mm
- Vacuuming Area: 430 mm
- Seal surface: 430x8 mm.
- Pump capacity: 20 m³/h.



Hazırlık Ekipmanları
Preparation EquipmentBıçak Sterilizatörü
Knife Sterilizer

andora



Kod Code	Ürün Adı Description	Ebatlar Dimension	Ağırlık Weight	Net Net	Güç Power	Kapasite Capacity
		a x b x c (mm)	(kg)	(m ³)	(w)	(adet/pieces)
AND.BST.001	Bıçak Sterilizatörü Knife Sterilizer	554x160x621	8	0.06	0.1	10

TEKNİK ÖZELLİKLER

- 0-120 dakika zaman ayarı.
- Renkli pleksiglas kapak.
- Paslanmaz çelik gövde.
- Ultraviyole ışın filtre sistemi.

TECHNICAL SPECIFICATIONS

- 0-120 minutes time setting.
- Colored plexiglass doors.
- Stainless steel body.
- Ultraviolet ray filter system.



Kod Code	Ürün Adı Description	Ebatlar Dimension	Ağırlık Weight	Net Net	Güç Power	Kapasite Capacity
		a x b x c (mm)	(kg)	(m ³)	(w)	(adet/pieces)
AND.BST.002	Bıçak Sterilizatörü Knife Sterilizer	1024x160x621	15	0.10	0.2	20

TEKNİK ÖZELLİKLER

- 0-120 dakika zaman ayarı.
- Renkli pleksiglas kapak.
- Paslanmaz çelik gövde.
- Ultraviyole ışın filtre sistemi.

TECHNICAL SPECIFICATIONS

- 0-120 minutes time setting.
- Colored plexiglass doors.
- Stainless steel body.
- Ultraviolet ray filter system.





Kod Code	Ürün Adı Description	Ebatlar Dimension	Ağırlık Weight	Net Net
		a x b x c (mm)	(kg)	(m ³)
AND.PRG.01	Profesyonel Duvar Tipi Izgara Elektrostatik Boyalı Professional Wall Type Grill Electrostatic Dyed	1600x750x2150	382	2.58
AND.PRG.02	Profesyonel Duvar Tipi Izgara Elektrostatik Boyalı Professional Wall Type Grill Electrostatic Dyed	2150x750x2150	495	3.47

TEKNİK ÖZELLİKLER

- 400x500 mm kömür yakma haznesi.
- 2 adet yüksekliği ayarlanabilir 510x530 mm kömür haznesi.
- 20 cm paslanmaz çelik ön çalışma tablası.
- Monoblok davlumbaz.
- Devrilir kömür saklama haznesi.
- Kül toplama çekmeceleri.
- Yanma işlemini hızlandıran ayarlanabilir hava penceresi.
- Ayarlanabilir havalandırma flapları.
- Dekoratif elektrostatik boyalı gövde.

TECHNICAL SPECIFICATIONS

- 400x500 mm charcoal burning reservoir.
- Height adjustable charcoal reservoir 2 pieces 510x530 mm
- 20 cm stainless steel front worktop.
- Monoblock hood.
- Tilting drawer for charcoal storage.
- Ash drawer.
- Adjustable air passage provides quick burning.
- Adjustable air circulating flaps.
- Decorative electrostatics dyed body.



**Kendinden Kömür Haznesi
ve Kül Çekmecesini**
Self-Contained Coal Hopper
and Ash Drawer

Hazırlık Ekipmanları
Preparation EquipmentProfesyonel Duvar Tipi Izgaralar
Professional Wall Type Grills

andora

Paslanmaz Duvar Tipi Kömürlü Izgara
Stainless Steel Wall Type Charcoal GrillPaslanmaz Duvar Tipi Gazlı Sulu Izgara
Stainless Steel Wall Type Gas Vapor Grill

CE

Izgaralar Fiyata Dahildir.
Grills are included in the price.

Kod Code	Ürün Adı Description	Ebatlar Dimension	Ağırlık Weight	Net Net	Kapasite Capacity
		a x b x c (mm)	(kg)	(m ³)	(izgara/grill cm)
AND.OCK.010-W	Paslanmaz Duvar Tipi Kömürlü Izgara Stainless Steel Wall Type Charcoal Grill	965x850x2150	225	1.83	80

AND.OCK.020-	Paslanmaz Duvar Tipi Kömürlü Izgara Stainless Steel Wall Type Charcoal Grill	1365x850x2150	290	2.5	120
--------------	---	---------------	-----	-----	-----

AND.OCK.030-W	Paslanmaz Duvar Tipi Kömürlü Izgara Stainless Steel Wall Type Charcoal Grill	1765x850x2150	355	3.2	160
---------------	---	---------------	-----	-----	-----

Kod Code	Ürün Adı Description	Ebatlar Dimension	Ağırlık Weight	Net Net	Kapasite Capacity
		a x b x c (mm)	(kg)	(m ³)	(izgara/grill cm)
AND.OCG.010-W	Paslanmaz Duvar Tipi Gazlı Sulu Izgara Stainless Steel Wall Type Gas Vapor Grill	965x850x2150	234	1.83	80

AND.OCG.020-W	Paslanmaz Duvar Tipi Gazlı Sulu Izgara Stainless Steel Wall Type Gas Vapor Grill	1365x850x2150	337	2.5	120
---------------	---	---------------	-----	-----	-----

TEKNİK ÖZELLİKLER

- Monoblok davlumbaz.
- Paslanmaz çelik gövde.
- Sulu veya kömürlü ızgara ile kullanıma uygun.
- Ateş tuğlalı kömür ızgarası.
- Kül Haznesi.
- Paslanmaz çelik gövde.

TECHNICAL SPECIFICATIONS

- Monoblock hood.
- Stainless steel body.
- Compatible with gas vapor or charcoal grill use.
- Coal grill firebrick.
- Ash Drawer.
- Stainless steel body.

AND.OCG.010-W

- Gaz Tüketim Değeri (ng): 1,10m³/h
- Gaz Tüketim Değeri (lpg): 1,20 kg/h

AND.OCG.020-W

- Gaz Tüketim Değeri (ng): 1,65 m³/h
- Gaz Tüketim Değeri (lpg): 1,80 kg/h

AND.OCG.010-W

- Gas Consumption (ng): 1,10 m³/h
- Gas Consumption (lpg): 1,20 kg/h

AND.OCG.020-W

- Gas Consumption (ng): 1,65 m³/h
- Gas Consumption (lpg): 1,80 kg/h



Kod Code	Ürün Adı Description	Ebatlar Dimension	Ağırlık Weight	Net Net	Güç Power	Kapasite Capacity
		a x b x c (mm)	(kg)	(m ³)	(kw)	(adet/saat pieces/hour)
AND.KFE.020	Elektrikli Kumpir Fırını 2 Çekmeceli Electrical Potato Baking Oven 2 Drawers	500x700x750	45	0.26	3	24-30
AND.KFE.030	Elektrikli Kumpir Fırını 3 Çekmeceli Electrical Potato Baking Oven 3 Drawers	500x700x980	60	0.34	4.5	36-45

TEKNİK ÖZELLİKLER

- Her çekmece için ayrı rezistans
- Çift izolasyonlu gövde.
- Dijital Termostat.

AND.KFE.020

- 3 kW 380V - 50 Hz güç.

AND.KFE.030

- 4.5 kW 380V - 50 Hz güç.

TECHNICAL SPECIFICATIONS

- Separated resistance in each drawer
- Double insulated body.
- Digital Thermostat.

AND.KFE.020

- Power: 3 kW 380V - 50 Hz

AND.KFE.030

- Power: 4.5 kW 380V - 50 Hz



Kod Code	Ürün Adı Description	Ebatlar Dimension	Ağırlık Weight	Net Net	Güç Power	Kapasite Capacity
		a x b x c (mm)	(kg)	(m ³)	(kw)	(adet/saat pieces/hour)
AND.KFG.020	Gazlı Kumpir Fırını 2 Çekmeceli Gas Potato Baking Oven 2 Drawers	500x700x950	55	0.33	4.9	24-30
AND.KFG.030	Gazlı Kumpir Fırını 3 Çekmeceli Gas Potato Baking Oven 3 Drawers	500x700x1200	73	0.42	4.9	36-45

TEKNİK ÖZELLİKLER

- Her çekmece için ayrı brülör.
- Çift izolasyonlu gövde.
- Emniyet ventili ve piezo çakmak ile kontrol.

AND.KFG.020 - AND.KFG.030

- Gaz Tüketim Değeri (ng): 0,51 m³/h
- Gaz Tüketim Değeri (lpg): 0,38 kg/h

TECHNICAL SPECIFICATIONS

- Separated burner in each drawer.
- Double insulated body.
- Piezo electric ignition system and safety valve.

AND.KFG.020 - AND.KFG.030

- Gas Consumption (ng): 0,51 m³/h
- Gas Consumption (lpg): 0,38 kg/h

Hazırlık Ekipmanları
Preparation EquipmentElektrikli Piliç Kızartma Makineleri
Electrical Chicken Rotisserie

andora

CE



Kod Code	Ürün Adı Description	Ebatlar Dimension	Ağırlık Weight	Net Net	Güç Power	Kapasite Capacity
		a x b x c (mm)	(kg)	(m ³)	(kw)	(adet/pieces)
AND.3EE	Elektrikli Piliç Kızartma Makinesi Electrical Chicken Rotisserie	1194x481x820	108	0.47	9.9	18
AND.5EE	Elektrikli Piliç Kızartma Makinesi Electrical Chicken Rotisserie	1194x481x1180	144	0.68	16.5	30
AND.8EE	Elektrikli Piliç Kızartma Makinesi Electrical Chicken Rotisserie	1194x481x2030	214	1.17	26.4	48

TEKNİK ÖZELLİKLER

- Her rezistans ayrı ayrı kontrol edilebilir.
- Kapak camları temperlidir.
- Şiş ve cam kapak tutma kulpları ısıya dayanıklı bakalitir.
- Elektrik tesisatı yüksek ısıya dayanıklıdır.
- Çelik dişli sistemi sessiz bir çalışma imkanı sağlar.
- Paslanmaz çelik gövde.
- Bakımı ve temizliği kolaydır.
- Her şiş 6 piliç alır.

TECHNICAL SPECIFICATIONS

- Each resistance can be controlled separately.
- Heat resistant tempered glass doors.
- Spear and door handles are made of heat resistant bakelite.
- Electrical fitting is durable to high temperatures.
- Steel gear system provides quiet operation.
- Stainless steel body.
- Provides simple maintain and easy cleaning.
- Each spear takes 6 chicken.





Kod Code	Ürün Adı Description	Ebatlar Dimension	Ağırlık Weight	Net Net	Güç Power	Kapasite Capacity
		a x b x c (mm)	(kg)	(m ³)	(kw)	(adet/pieces)
AND.3EG	Gazlı Piliç Kızartma Makinesi Gas Chicken Rotisserie	1194x481x820	108	0.47	19.4	18
AND.5EG	Gazlı Piliç Kızartma Makinesi Gas Chicken Rotisserie	1194x481x1180	144	0.68	32.33	30
AND.8EG	Gazlı Piliç Kızartma Makinesi Gas Chicken Rotisserie	1194x481x2030	214	1.17	51.73	48

TEKNİK ÖZELLİKLER

- Lpg ve doğalgaza uyumludur.
- Kumanda muslukları emniyet ventillidir.
- Her brülör ayrı ayrı kontrol edilebilir.
- Kapak camları temperlidir.
- Çelik dişli sistemi sessiz bir çalışma imkanı sağlar.
- Şiş ve cam kapak tutma kulpları ısıya dayanıklı bakalitir.
- Elektrik tesisatı yüksek ısıya dayanıklıdır.
- Paslanmaz çelik gövde.
- Bakımı ve temizliği kolaydır.
- Her şiş 6 piliç alır.

AND.3EG

- Gaz Tüketim Değeri (ng): 2,05 m³/h
- Gaz Tüketim Değeri (lpg): 1,52 kg/h

AND.5EG

- Gaz Tüketim Değeri (ng): 3,41 m³/h
- Gaz Tüketim Değeri (lpg): 2,53 kg/h

AND.8EG

- Gaz Tüketim Değeri (ng): 5,47 m³/h
- Gaz Tüketim Değeri (lpg): 4,05 kg/h

TECHNICAL SPECIFICATIONS

- LPG or NG.
- Safety valve.
- Each burner can be controlled separately.
- Heat resistant tempered glass doors.
- Steel gear system provides quiet operation.
- Spear and door handles are made of heat resistant bakelite.
- Electrical fitting is durable to high temperatures.
- Stainless steel body.
- Easy cleaning.
- Each spear takes 6 chicken.

AND.3EG

- Gas Consumption (ng): 2,05 m³/h
- Gas Consumption (lpg): 1,52 kg/h

AND.5EG

- Gas Consumption (ng): 3,41 m³/h
- Gas Consumption (lpg): 2,53 kg/h

AND.8EG

- Gas Consumption (ng): 5,47 m³/h
- Gas Consumption (lpg): 4,05 kg/h



Hazırlık Ekipmanları
Preparation Equipment**+ Piliç Kızartma Makineleri**
+ Chicken Rotisserie**andora**

CE



Kod Code	Ürün Adı Description	Ebatlar Dimension	Ağırlık Weight	Net Net	Güç Power	Kapasite Capacity
		a x b x c (mm)	(kg)	(m ³)	(kw)	(adet/pieces)
AND.PLS.5EE	Plus Gold Piliç Kızartma Makinesi Elektrikli Plus Gold Electrical Chicken Rotisserie	1194x565x2030	193	1.37	16.50	30
AND.PLS.5EG	Plus Gold Piliç Kızartma Makinesi Gazlı Plus Gold Gas Chicken Rotisserie	1194x565x2030	208	1.37	32.33	30

TEKNİK ÖZELLİKLER

- Pişirme tipi elektrikli veya gazlı olup, her radyan ayrı ayrı kontrol edilebilir.
- Kapak camları temperlidir.
- Şiş ve cam kapak tutma kulpları ısıya dayanıklı bakalitir.
- Elektrik tesisatı yüksek ısıya dayanıklıdır.
- Çelik dişli sistemi sessiz bir çalışma imkanı sağlar.
- Paslanmaz çelik gövde.
- Bakımı ve temizliği kolaydır.
- Her şiş 6 piliç alır.

TECHNICAL SPECIFICATIONS

- Roasting type operates electrically or gas and each radian may controlled separately.
- Heat resistant tempered glass doors.
- Spear and door handles are made of heat resistant bakelite.
- Electrical fitting is durable to high temperatures.
- Steel gear system provides quiet operation.
- Stainless steel body.
- Provides simple maintain and easy cleaning.
- Each spear takes 6 chicken.

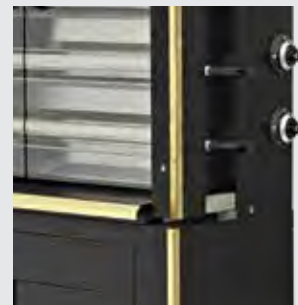
**AND.PLS.5EE / AND.PLS.5EG****AND.PLS.5EG**

- Gaz Tüketim Değeri (ng): 3,41 m³/h
- Gaz Tüketim Değeri (lpg): 2,53 kg/h

AND.PLS.5EG

- Gas Consumption (ng): 3,41 m³/h
- Gas Consumption (lpg): 2,53 kg/h



Kod Code	Ürün Adı Description	Ebatlar Dimension	Ağırlık Weight	Net Net	Kapasite Capacity
		a x b x c (mm)	(kg)	(m ³)	(şiş/skewer)
AND.5YI	Kömürlü Yatay Piliç Kızartma Makinesi Horizontal Chicken Rotisserie with Charcoal	1200x930x1100	245	1.22	5
AND.6YI	Kömürlü Yatay Piliç Kızartma Makinesi Horizontal Chicken Rotisserie with Charcoal	1400x930x1100	270	1.43	6
AND.8YI	Kömürlü Yatay Piliç Kızartma Makinesi Horizontal Chicken Rotisserie with Charcoal	1800x930x1100	345	1.84	8

TEKNİK ÖZELLİKLER

- Sökülebilir şiş sistemi.
- Kül çekmeceli.
- Hareketli sistem.
- Taban ve yanlar ateş tuğlalı.
- Çelik dişli sistemi sessiz çalışma imkanı sağlar.
- Paslanmaz çelik gövde.
- Bakımı ve temizliği kolaydır.

TECHNICAL SPECIFICATIONS

- Detachable skewer system.
- With ash drawer.
- With wheels system.
- Base and sides with firebrick.
- Steel gear system provides silent working.
- Stainless steel body.
- Easy cleaning and maintaining.



Hazırlık Ekipmanları
Preparation EquipmentElektrikli Isıtılmalı Teşhir Üniteleri
Food Warmer Display

andora

CE



Kod Code	Ürün Adı Description	Ebatlar Dimension	Ağırlık Weight	Net Net	Güç Power	Kapasite Capacity
		a x b x c (mm)	(kg)	(m ³)	(kw)	(gn)
AND.PLC-D-GN21	Elektrikli Isıtılmalı Teşhir Ünitesi Food Warmer Display	800x691x932	72	0.51	2	2x1/1 Gn Alt/Bottom 2x2/3 Gn Üst/Top
AND.PLC-D-GN31	Elektrikli Isıtılmalı Teşhir Ünitesi Food Warmer Display	1150x691x932	93	0.74	2.7	3x1/1 Gn Alt/Bottom 3x2/3 Gn Üst/Top
AND.PLC-D-GN41	Elektrikli Isıtılmalı Teşhir Ünitesi Food Warmer Display	1500x691x932	112	0.97	4	4x1/1 Gn Alt/Bottom 4x2/3 Gn Üst/Top
AND.PLC-D-GN51	Elektrikli Isıtılmalı Teşhir Ünitesi Food Warmer Display	1800x691x932	128	1.15	4.7	5x1/1 Gn Alt/Bottom 5x2/3 Gn Üst/Top

TEKNİK ÖZELLİKLER

- Termostatik kontrol.
- Otomatik su doldurma ve boşaltma sistemi.
- İç aydınlatma.
- Ergonomik tasarım.
- Çalışma aralığı: 30 °C / 90 °C
- Pres baskı iç havuz sistemi.
- Paslanmaz çelik gövde.

TECHNICAL SPECIFICATIONS

- Thermostatic control.
- Automatic water filling and drain system.
- Inside lighting.
- Ergonomic design.
- Working temperature: 30 °C / 90 °C
- Pressed stainless steel inner pool system.
- Stainless steel body.





Kod Code	Ürün Adı Description	Ebatlar Dimension	Ağırlık Weight	Net Net
		a x b x c (mm)	(kg)	(m ³)
AND.DKE.001	Dizden Kumandalı El Yıkama Evyesi Knee Operating Handwash Basin	505x450x220	7	0.05
AND.DKE.002	Dizden Kumandalı El Yıkama Evyesi Knee Operating Handwash Basin	400x400x220	6	0.04

TEKNİK ÖZELLİKLER

- 15 saniye boyunca su akıtma özelliği.
- Duvara monte edilebilir.
- Paslanmaz çelik gövde.

TECHNICAL SPECIFICATIONS

- 15 seconds water flow is available in every operation.
- Wall-mounted option.
- Stainless steel body.



Kod Code	Ürün Adı Description	Ebatlar Dimension	Ağırlık Weight	Net Net	Evye Sink
		a x b x c (mm)	(kg)	(m ³)	(mm)
AND.PE.5060	Paspas Yıkama Evyesi Janitorial Sink Unit	500x600x900	16	0.27	400x400x250
AND.PE.5070	Paspas Yıkama Evyesi Janitorial Sink Unit	500x700x900	18	0.32	400x400x250

andora



www.turkeyner.com

Taşıma Ekipmanları Carrying Equipment



andora

andora

TAŞIMA EKİPMANLARI

Nötr Banket Arabası
Sıcak Banket Arabaları
Soğuk Banket Arabaları
PLUS Sıcak Banket Arabaları
PLUS Soğuk Banket Arabaları
PLUS Sıcak-Soğuk Banket Arabaları
Sıcak Mobil Benmariler
Sıcaklık Dolapları
Çekmeceli Isıtma Üniteleri
Sıcak - Soğuk Yemek Dağıtım Arabaları
Yemek Dağıtım Araba Aksesuarları
Yemek Dağıtım Arabaları için Kırılmaz Tabaklar
Termobox
Epp Carrybox
Servis Çantaları
Plastik Servis Arabaları
Servis Arabaları
Ayaktan Kumandalı El Yıkama Evyeleri
Elektrikli Mobil Dezenfektan İstasyonu
Dezenfektan İstasyonları
Mutfak Bulaşık Arabaları
Servis Arabaları
Taşıma ve Muhafaza Arabaları
Tabak Otomatları
Tabak Otomatları ve Yağ Ayırıcılar
Oda Servis Üniteleri

CARRYING EQUIPMENT

Neutral Banquet Trolley
Hot Banquet Trolleys
Cold Banquet Trolleys
PLUS Hot Banquet Trolleys
PLUS Cold Banquet Trolleys
PLUS Hot-Cold Banquet Trolleys
Hot Mobil Bainmaries
Hot Cupboards
Drawer Warmers
Hot - Cold Meal Distribution Trolleys
Meal Distribution Trolley Accessories
Unbreakable Plates for Meal Distribution Trolleys
Termobox
Epp Carrybox
Service Bags
Plastic Service Trolleys
Service Trolleys
Foot Operated Hand Wash Sinks
Electrical Mobile Disinfection Station
Disinfection Stations
Kitchen Trolleys
Service Trolleys
Mobile Storage Bins and Transport Carts
Plate Dispensers
Plate Dispensers and Grease Separator
Hotel Service Units



Kod Code	Ürün Adı Description	Ebatlar Dimension	Ağırlık Weight	Net Net	Kapasite Capacity
		a x b x c (mm)	(kg)	(m ³)	(gn)
AND.BQ3-002-N	Nötr Banket Arabası Neutral Banquet Trolley	716x888x1275	131	0.81	8x2/1

TEKNİK ÖZELLİKLER

- Kilitlenebilir tekerlekler ile sabitleyebilme özelliği.
- 40 kg/m³ yoğunluk poliüretan izolasyon.
- Paslanmaz çelik gövde.

TECHNICAL SPECIFICATIONS

- Lockable castors provide stabilizing.
- Isolation type: 40 kg/m³ density polyurathane isolation.
- Stainless steel body.

**Pres baskı iç tepsi kızakları**
Pressed interior tray slids

Taşıma Ekipmanları Carrying Equipment

Sıcak Banket Arabaları Hot Banquet Trolleys

andora

CE



AND.BQ1



AND.BQ2



AND.BQ3



Kod Code	Ürün Adı Description	Ebatlar Dimension	Ağırlık Weight	Net Net	Güç Power	Kapasite Capacity
		a x b x c (mm)	(kg)	(m ³)	(kw)	(gn)
AND.BQ1	Sıcak Banket Arabası Hot Banquet Trolley	716x888x1835	124	1.21	3	11x2/1 Gn
AND.BQ2	Sıcak Banket Arabası Hot Banquet Trolley	1350x888x1835	200	2.17	3	2x(11x2/1 Gn)
AND.BQ3	Sıcak Banket Arabası Hot Banquet Trolley	716x888x1251	60	0.79	3	6x2/1 Gn
AND.BQ4	Sıcak Banket Arabası Hot Banquet Trolley	581x769x1683	94	0.75	3	15x1/1 Gn

TEKNİK ÖZELLİKLER

- 220V çalışma voltajı.
- Dijital termostat kontrol ünitesi.
- İç ısı göstergesi.
- Nemlendirme.
- Mıknatıslı kilit.
- Kilitlenebilir tekerlekler ile sabitleyebilme özelliği.
- 40 kg/m³ yoğunluk poliüretan izolasyon.
- Tüm koşullarda hızlı ısıtma imkanı sağlayan optimize edilmiş güçlü hava sirkülasyonu sayesinde homojen ısı dağılımı sağlar.
- Paslanmaz çelik gövde.
- Çalışma aralığı: 0 °C / 75 °C

TECHNICAL SPECIFICATIONS

- Operating voltage: 220V
- Digital thermostat control unit.
- Interior heating indicator.
- Humidification system.
- Magnetic locker.
- Lockable castors provide stabilizing.
- Isolation type: 40 kg/m³ density polyurathane isolation.
- Optimized strong air circulation provides homogenic air flow from bottom to top in all conditions.
- Stainless steel body.
- Working temperature: 0 °C / 75 °C



Pres baskı iç tepsi kızakları
Pressed interior tray slides



Çıkarılabilir ısıtma sistemi
Removable heating system



AND.BQ4



AND.BQ1-5



AND.BQ2-5



AND.BQ3-5



Kod Code	Ürün Adı Description	Ebatlar Dimension	Ağırlık Weight	Net Net	Güç Power	Kapasite Capacity
		a x b x c (mm)	(kg)	(m ³)	(kw)	(gn)
AND.BQ1-5	Soğuk Banket Arabası Cold Banquet Trolley	716x888x1835	131	1.16	0.20	11x2/1 Gn
AND.BQ2-5	Soğuk Banket Arabası Cold Banquet Trolley	1350x888x1835	225	2.20	0.30	2x(11x2/1 Gn)
AND.BQ3-5	Soğuk Banket Arabası Cold Banquet Trolley	716x888x1251	102	0.79	0.20	6x2/1 Gn
AND.BQ4-5	Soğuk Banket Arabası Cold Banquet Trolley	581x769x1683	107	0.71	0.18	15x1/1 Gn

TEKNİK ÖZELLİKLER

- 220V - 240V -1 +N - 50 60 Hz elektrik gücü.
- "CFC Free" R-134 A soğutucu gaz.
- 220V çalışma voltajı.
- Dijital termostat kontrol ünitesi.
- Manyetik kilit.
- Kilitlenebilir tekerlekler ile sabitleyebilme özelliği.
- 40 kg/m³ yoğunluk poliüretan izolasyon.
- Paslanmaz çelik gövde.
- Çalışma aralığı: 0 °C / +5 °C (tropikal 43 °C)

TECHNICAL SPECIFICATIONS

- 220V - 240V -1 +N - 50 60 Hz electrical power.
- "CFC Free" R-134 A refrigerant gas.
- Operating voltage: 220V
- Digital thermostat control unit.
- Magnetic locker.
- Lockable castors provide stabilizing.
- Isolation type: 40 kg/m³ density polyurathane isolation.
- Stainless steel body.
- Working temperature: 0 °C / +5 °C (at ambient temp. 43 °C)

R-290 Soğutucu Gaz Tipi için %3 fiyat farkı ekleyiniz. / Please add %3 price difference for R-290 refrigerant gas.



Pres baskı iç tepsi kızakları
Pressed interior tray slides



Darbelerle Karşı Koruma Tamponu
Impact Protection Buffer



AND.BQ4-5

Taşıma Ekipmanları Carrying Equipment

+ Sıcak Banket Arabaları
+ Hot Banquet Trolleys

andora



AND.BQ1-12H
AND.BQ2-12H



AND.BQ1-12+12H
AND.BQ2-12+12H



Kod Code	Ürün Adı Description	Ebatlar Dimension	Ağırlık Weight	Net Net	Güç Power	Kapasite Capacity
		a x b x c (mm)	(kg)	(m³)	(kw)	(gn)
AND.BQ1-12H	Plus Sıcak Banket Arabası Plus Hot Banquet Trolley	536x920x1480	65	0.73	1.9	12x1/1 Gn
AND.BQ2-12H	Plus Sıcak Banket Arabası Plus Hot Banquet Trolley	740x1036x1480	79	1.14	1.9	12x2/1 Gn
AND.BQ1-12+12H	Plus Sıcak Banket Arabası Plus Hot Banquet Trolley	1115x920x1400	130	1.44	3.8	24x1/1 Gn
AND.BQ2-12+12H	Plus Sıcak Banket Arabası Plus Hot Banquet Trolley	1526x1036x1400	152	2.22	3.8	24x2/1 Gn

TEKNİK ÖZELLİKLER

- 220V çalışma voltajı.
- Dijital termostat kontrol ünitesi.
- Panadur sandviç panel.
- Tam açılabilir kapı sistemi.
- İç ısı göstergesi.
- Kilitlenebilir tekerlekler ile sabitleyebilme özelliği.
- Paslanmaz tepsi kızakları.
- Alüminyum gövde.
- Çalışma aralığı: 65 °C / 75 °C

TECHNICAL SPECIFICATIONS

- Operating voltage: 220V
- Digital thermostat control unit.
- Panadur sandwich panel.
- Fully openable door system.
- Interior heating indicator.
- Lockable castors provide stabilizing.
- Stainless steel tray slides.
- Aluminium body.
- Working temperature: 65 °C / 75 °C



AND.BQ1-12C
AND.BQ2-12CAND.BQ1-12+12C
AND.BQ2-12+12C

Kod Code	Ürün Adı Description	Ebatlar Dimension	Ağırlık Weight	Net Net	Güç Power	Kapasite Capacity
		a x b x c (mm)	(kg)	(m ³)	(kw)	(gn)
AND.BQ1-12C	Plus Soğuk Banket Arabası Plus Cold Banquet Trolley	536x920x1480	80	0.73	0.15	12x1/1 Gn
AND.BQ2-12C	Plus Soğuk Banket Arabası Plus Cold Banquet Trolley	740x1036x1480	94	1.14	0.15	12x2/1 Gn
AND.BQ1-12+12C	Plus Soğuk Banket Arabası Plus Cold Banquet Trolley	1115x920x1400	160	1.44	0.3	24x1/1 Gn
AND.BQ2-12+12C	Plus Soğuk Banket Arabası Plus Cold Banquet Trolley	1526x1036x1400	182	2.22	0.3	24x2/1 Gn

TEKNİK ÖZELLİKLER

- 220V - 230V -1 +N - 50 60 Hz elektrik gücü.
- "CFC Free" R-134 A soğutucu gaz.
- Dijital termostat kontrol ünitesi.
- Panadur sandviç panel.
- Tam açılabilir kapı sistemi.
- Kilitlenebilir tekerlekler ile sabitleyebilme özelliği.
- Paslanmaz tepsi kızakları.
- Alüminyum gövde.
- Çalışma aralığı: +4 °C / +10 °C (tropikal 43 °C)

TECHNICAL SPECIFICATIONS

- 220V - 230V -1 +N - 50 60 Hz electrical power.
- "CFC Free" R-134 A refrigerant gas.
- Digital thermostat control unit.
- Panadur sandwich panel.
- Fully openable door system.
- Lockable castors provide stabilizing.
- Stainless steel tray slides.
- Aluminium body.
- Working temperature: +4 °C / +10 °C (at ambient temp. 43 °C)



R-290 Soğutucu Gaz Tipi için lütfen sorunuz.
Please ask for R-290 refrigerant gas.

Taşıma Ekipmanları Carrying Equipment

+ Sıcak-Soğuk Banket Arabaları
+ Hot-Cold Banquet Trolleys

andora



AND.BQ1-6+6HC
AND.BQ2-6+6HC



AND.BQ1-12+12HC
AND.BQ2-12+12HC



Kod Code	Ürün Adı Description	Ebatlar Dimension	Ağırlık Weight	Net Net	Güç Power	Kapasite Capacity
		a x b x c (mm)	(kg)	(m ³)	(kw)	(gn)
AND.BQ1-6+6HC	Plus Sıcak-Soğuk Banket Arabası Plus Hot-Cold Banquet Trolley	536x920x1640	95	0.81	2.05	6x1/1 Gn Sıcak-Hot 6x1/1 Gn Soğuk-Cold
AND.BQ2-6+6HC	Plus Sıcak-Soğuk Banket Arabası Plus Hot-Cold Banquet Trolley	740x1036x1640	117	1.26	2.05	6x2/1 Gn Sıcak-Hot 6x2/1 Gn Soğuk-Cold
AND.BQ1-12+12HC	Plus Sıcak-Soğuk Banket Arabası Plus Hot-Cold Banquet Trolley	1115x920x1400	162	1.44	2.05	12x1/1 Gn Sıcak-Hot 12x1/1 Gn Soğuk-Cold
AND.BQ2-12+12HC	Plus Sıcak-Soğuk Banket Arabası Plus Hot-Cold Banquet Trolley	1526x1036x1400	182	2.22	2.05	12x2/1 Gn Sıcak-Hot 12x2/1 Gn Soğuk-Cold

TEKNİK ÖZELLİKLER

- 220V - 230V -1 +N - 50 60 Hz elektrik gücü.
- "CFC Free" R-134 A soğutucu gaz.
- Dijital termostat kontrol ünitesi.
- Panadur sandviç panel.
- Tam açılabilir kapı sistemi.
- İç ısı göstergesi.
- Kilitlenebilir tekerlekler ile sabitleyebilme özelliği.
- Paslanmaz tepsi kızakları.
- Alüminyum gövde.
- Sıcak çalışma aralığı: 65 °C / 75 °C
- Soğuk çalışma aralığı: +4 °C / +10 °C (tropikal 43 °C)

TECHNICAL SPECIFICATIONS

- 220V - 230V -1 +N - 50 60 Hz electrical power.
- "CFC Free" R-134 A refrigerant gas.
- Digital thermostat control unit.
- Panadur sandwich panel.
- Fully openable door system.
- Interior heating indicator.
- Lockable castors provide stabilizing.
- Stainless steel tray slides.
- Aluminium body.
- Hot working temperature: 65 °C / 75 °C
- Cold Working temperature: +4 °C / +10 °C (at ambient temp. 43 °C)



R-290 Soğutucu Gaz Tipi için lütfen sorunuz.
Please ask for R-290 refrigerant gas.



Kod Code	Ürün Adı Description	Ebatlar Dimension	Ağırlık Weight	Net Net	Güç Power	Kapasite Capacity
		a x b x c (mm)	(kg)	(m ³)	(kw)	(gn)
AND.MBLB.01	Sıcak Mobil Benmari Hot Mobile Bainmarie	855x705x850	39	0.51	1,75	2x1/1 Gn
AND.MBLB.02	Sıcak Mobil Benmari Hot Mobile Bainmarie	1185x705x850	45	0.67	1,75	3x1/1 Gn
AND.MBLB.03	Sıcak Mobil Benmari Hot Mobile Bainmarie	1505x705x850	60	0.90	1,75	4x1/1 Gn

TEKNİK ÖZELLİKLER

- Elektrikli termostatik ısı kontrolü.
- Kilitlenebilir tekerlekler ile sabitleme özelliği.
- Paslanmaz çelik gövde.

TECHNICAL SPECIFICATIONS

- Electric thermostatic temperature control.
- Fixing feature with lockable wheels.
- Stainless steel body.



**Pres baskı iç havuz sistemi.
Pressed inner pool system.**



İzolasyonsuz / Non Insulated

Kod Code	Ürün Adı Description	Ebatlar Dimension	Ağırlık Weight	Net Net	Güç Power
		a x b x c (mm)	(kg)	(m ³)	(kw)
AND.IDP.7120	Sıcaklık Dolabı - İzolasyonsuz Hot Cupboard - Non Insulated	1200x700x850	82	0.71	1.4
AND.IDP.7140	Sıcaklık Dolabı - İzolasyonsuz Hot Cupboard - Non Insulated	1400x700x850	93	0.83	1.6
AND.IDP.7160	Sıcaklık Dolabı - İzolasyonsuz Hot Cupboard - Non Insulated	1600x700x850	102	0.95	1.8
AND.IDP.7180	Sıcaklık Dolabı - İzolasyonsuz Hot Cupboard - Non Insulated	1800x700x850	131	1.07	2
AND.IDP.7200	Sıcaklık Dolabı - İzolasyonsuz Hot Cupboard - Non Insulated	2000x700x850	142	1.19	2.2

İzolasyonlu / Insulated

Kod Code	Ürün Adı Description	Ebatlar Dimension	Ağırlık Weight	Net Net	Güç Power
		a x b x c (mm)	(kg)	(m ³)	(kw)
AND.IDP.7120-I	Sıcaklık Dolabı - İzolasyonlu Hot Cupboard - Insulated	1200x700x850	82	0.71	1.4
AND.IDP.7140-I	Sıcaklık Dolabı - İzolasyonlu Hot Cupboard - Insulated	1400x700x850	93	0.83	1.6
AND.IDP.7160-I	Sıcaklık Dolabı - İzolasyonlu Hot Cupboard - Insulated	1600x700x850	102	0.95	1.8
AND.IDP.7180-I	Sıcaklık Dolabı - İzolasyonlu Hot Cupboard - Insulated	1800x700x850	131	1.07	2
AND.IDP.7200-I	Sıcaklık Dolabı - İzolasyonlu Hot Cupboard - Insulated	2000x700x850	142	1.19	2.2

TEKNİK ÖZELLİKLER

- Paslanmaz çelik gövde.
- Çalışma aralığı: 0 °C / 90 °C

TECHNICAL SPECIFICATIONS

- Stainless steel body.
- Working temperature: 0 °C / 90 °C



Kod Code	Ürün Adı Description	Ebatlar Dimension	Ağırlık Weight	Net Net	Güç Power
		a x b x c (mm)	(kg)	(m ³)	(kw)
AND.EI.01	Tek Çekmeceli Isıtma Ünitesi Single Drawer Heating Unit	825x640x405	45	0.2	2
AND.EI.02	2 Çekmeceli Isıtma Ünitesi 2 Drawers Heating Unit	825x640x680	69	0.3	4
AND.EI.03	3 Çekmeceli Isıtma Ünitesi 3 Drawers Heating Unit	825x640x960	98	0.9	6

TEKNİK ÖZELLİKLER

- 220V çalışma voltajı.
- Her çekmece için ayrı ayrı kontrol edilebilir termostatik kontrol.
- İzolasyonlu iç gövde.
- Dayanıklı çekmece iç kızakları.
- Paslanmaz çelik gövde.
- 1/1 Gn Küvet Kapasitesi.
- Çalışma aralığı: 0 °C / 90 °C

TECHNICAL SPECIFICATIONS

- Operating voltage: 220V
- Each drawer has separate thermostatic control.
- Insulated inner body.
- Heavy duty drawer slides.
- Stainless steel body.
- 1/1 Gn Capacity.
- Working temperature: 0 °C / 90 °C



Taşıma Ekipmanları Carrying Equipment

Sıcak - Soğuk Yemek Dağıtım Arabaları Hot - Cold Meal Distribution Trolleys

andora

CE



Hastanelerde, kliniklerde ve benzeri yerlerde kolaylıkla yemek taşımak ve yemeği gerekli sıcaklıkta muhafaza etmek için üretilmiş bu araç özel dizaynı sayesinde kullanıcıya kolaylık sağlar. Araçlar yan yana ve arka arkaya kolayca dizilebilir ve bu sayede işletmelerde yer kaplamaz. Kompakt yapısı sayesinde kolayca katlar arasında taşınabilir, katlarda yer kaplamadan çalışabilir. İki tarafta yer alan itme kulpları sayesinde kullanıcı kolay şekilde aracı hareket ettirebilir manevra yaptırabilir. Ayrıca araç üzerinde yer alan altı adet tekerlek ile araç kolaylıkla kendi etrafında dönebilir. Aracın ön kısmında yer alan katlanabilir tepsi masası ile kullanıcı istediği zaman tepsilerini koyabilir, yada ihtiyacı doğrultusunda bu masadan yardım alabilir.

Araç üzerinde yer alan 7" ekran kullanıcıya kolaylık sağlar, dokunmatik ekran sayesinde kullanıcı çok kolay şekilde program seçebilir ve/veya yeni program yapabilir. Araba üzerinde yer alan birçok parça kolaylıkla sökülüp takılabilir. Bu sayede servis ve bakım masrafsız şekilde yapılmış olur. Arabanın ömrü uzar ve uzun süreler hizmet verebilir.

Alt kısımda yer alan tamponlar sayesinde araç darbelerle karşı korunaklıdır. Bu sayede içinde taşınan gıdanın da güvenliği sağlanmış olur. Aracın kapıları kolaylıkla açılır. Orta kısımda yer alan kilit mekanizması sayesinde istenildiği zaman kilitlenebilir ve katta araç operasyonda iken gıdalara izni olmayan kişilerin erişimi durdurulmuş olur. Kapılar açıldıktan sonra aracın arka kısmına katlanır ve böylece yerden de tasarruf edilmiş olur. Bu sayede kolayca tepsiler yerleştirilir, tepsiler çıkarılabilir ayrıca araç içi temizliği kolayca yapılabilir.

Araçlar porsiyonlama mutfağında porsiyonlanan tepsiler ile doldurulur. Tepsiler ile doldurulan araçlar katlara çıkarılır. Araç iki bölümden oluşmaktadır. Bu iki bölme ayıran izolasyon duvarı vardır. Aracın soğuk bölmesi +4°C'de (ayarlanabilir 0°C / +6°C), sıcak bölmesi ise 100°C'de (ayarlanabilir 50°C / 100°C) tutulur. Yemekler servis edilene kadar iç sıcaklıkları en doğru değerlerde muhafaza olunur ve hasta yatağına kadar bu değerler değişmez.

It is designed to carry and deliver the meals easily in hospitals, clinics and similar places and keeps the food at the required temperature. Trolleys can be easily stored side by side and back-to-back so that they do not occupy so much space in the operation. Thanks to its compact structure, it can be easily moved between floors, work at the floors easily. Thanks to push handles on both sides, the user can easily maneuver the trolley. In addition, with six wheels on the trolley, it can easily turn around itself. With the foldable tray table located at the front of the trolley, the user can put trays at any time and can get help from this table in the direction of need.

The 7" screen on the vehicle provides convenience to the user, which he can easily select the program and / or make a new program with the touch screen. Many parts on the trolley can be easily removed and installed back. At this point, service and maintenance are done at no cost. The lifetime of the trolley is much longer and it can serve for a long time.

Thanks to the bumpers located at the bottom, the trolley is protected against impacts. By this the food being transported is also secured. The doors of the trolley are easily opened. Thanks to the locking mechanism located in the middle, it can be locked whenever requested, and when the trolley is in the operation at the floor, the access of the unauthorized persons is stopped. Once the doors are opened, they are folded to the rear of the trolley, which helps saving space. In this way, trays can be easily placed, trays can be removed and trolley can be cleaned easily.

The trolleys are filled with the trays which are prepared at the portioning kitchen and they are transported to the patient floors. The vehicle consists of two compartments. There is an isolation wall separating these two chambers. The cold compartment of the trolley is at + 4°C (adjustable 0°C / + 6°C), the hot compartment is at 100 ° C (adjustable 50°C / 100°C.). As long as the meals are served, the internal temperatures are kept at the right values and these values do not change until the food served to patient bed.



Touch Screen



Kod Code	Ürün Adı Description	Ebatlar Dimension a x b x c (mm)	Ağırlık Weight (kg)	Net Net (m ³)	Tepsi Kapasitesi Tray Capacity (adet/pieces)
AND.MED.S.24-1/2	Sıcak - Soğuk Yemek Dağıtım Arabası Hot - Cold Meal Distribution Trolley	811x1139x1382	195	1.28	24
AND.MED.S.24-1/3	Sıcak - Soğuk Yemek Dağıtım Arabası Hot - Cold Meal Distribution Trolley	811x1139x1382	195	1.28	24
AND.MED.S.30-1/2	Sıcak - Soğuk Yemek Dağıtım Arabası Hot - Cold Meal Distribution Trolley	811x1139x1619	215	1.50	30
AND.MED.S.30-1/3	Sıcak - Soğuk Yemek Dağıtım Arabası Hot - Cold Meal Distribution Trolley	811x1139x1619	215	1.50	30

TEKNİK ÖZELLİKLER

- IP-65 korumalı USB portu
- IP-65 korumalı ethernet portu
- Kablosuz ağ (WI-FI) bağlantı özelliği
- Dahili aküsü sayesinde hareket halindeyken sıcaklık verisini toplayabilme.
- Geçmişe dönük 1 yıllık sıcaklık verisini dahili hafızasında tutabilme
- Usb bellek, kablolu veya kablosuz ağ üzerinden MED-SOFT yazılımına veri aktarabilme.
- Ekranda akü durumunu ve tarihi gösterme
- Ekranda arabanın ait olduğu departmanın etiketini gösterme.
- +50°C ile +90°C derece arasında sıcak kompartman ısı ayarı
- 0°C ile +6°C arasında soğuk kompartman ısı ayarı
- 4 adet ayarlanabilir program ile istenilen sıcaklık ve zaman ayarı ile programlama yapabilme.
- Tepsi Ebatları: 575x325 mm
- Tepsi Tipi: Gn 1/2 - Gn 1/3

AND.MED.S.24-1/2 - AND.MED.S.24-1/3

- Güç: 5-1.3 kW

AND.MED.S.30-1/2 - AND.MED.S.30-1/3

- Güç: 5.6-1.3 kW

TECHNICAL SPECIFICATIONS

- IP-65 protected USB port
- IP-65 protected ethernet port
- Wireless WI-FI communication system
- Internal battery helps to collect data when the trolley is not plugged.
- Data storage for one year in the memory.
- Data transfer from the USB memory stick, cable connection or wireless connection to software MED-SOFT in the main computer.
- Battery and date information display on the screen.
- Adress and the department information of the trolley display on the screen.
- Hot compartment temperature can be adjustable between +50°C ile +100°C
- Cold compartment temperature can be adjustable between 0°C and +6°C.
- 4 cycle programs can be adjustable with the required temperature and time.
- Tray Size: 575x325 mm
- Tray Type: Gn 1/2 - Gn 1/3

AND.MED.S.24-1/2 - AND.MED.S.24-1/3

- Power: 5-1.3 kW

AND.MED.S.30-1/2 - AND.MED.S.30-1/3

- Power: 5.6-1.3 kW



Taşıma Ekipmanları Carrying Equipment

Yemek Dağıtım Araba Aksesuarları Meal Distribution Trolley Accessories

andora

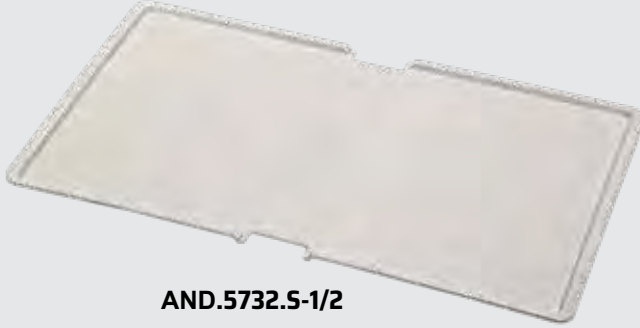

AND.5732.S-1/2



AND.5732.S-1/3

Kod Code	Ürün Adı Description	Ebatlar Dimension a x b x c (mm)
AND.5732.S-1/2	1/2 Sıcak - Soğuk Araba Özel Tepsisi 1/2 Hot-Cold Trolley Special Tray	575x325
AND.5732.S-1/3	1/3 Sıcak - Soğuk Araba Özel Tepsisi 1/3 Hot-Cold Trolley Special Tray	575x325
AND.MED.SOFT	MED-SOFT Yazılım MED-SOFT Software	



AND.MED.SOFT

*** 1/2 TEPŞİ : Bu tepsiler ara duvara yerleşirken %50/%50 olarak bölünmüştür. Sıcak taraf ve soğuk taraf genişlik ve derinlik olarak aynıdır.**

* These 1/2 trays are divided into 50% / 50% when they are fitted in the partition wall. The hot side and the cold side of the trays are the same in width and depth when they are settled in the trolley.

**** 1/3 TEPŞİ : Bu tepsiler ara duvara yerleşirken %37/%63 olarak bölünmüştür. Sıcak taraf geniş ve soğuk taraf dar olarak planlanmıştır. Böylece sıcak tarafa 3 kap (Ø12, Ø21, Ø17) sıcak yemek konabilir.**

* These 1/3 trays are divided into %37 / %63 when they are fitted in the partition wall. The hot side is wide and the cold side is narrow when they are settled in the trolley. By this 3 dishes can be loaded on the hot side of the tray. (Ø12, Ø21, Ø17) hot dishes can be loaded **at the same time.**

Ürün Görseli Product Picture	Kod Code	Ürün Adı Description
	AND.MED. JØ12T	Çorba Kasesi Soup Plate Beyaz Ø 12 mm White Ø12 mm
	AND.MED. JØ12K	Çorba Kasesi Kapağı Soup Plate Lid

	AND.MED. ÇØ21T	Çukur Yemek Tabağı Hot Dish Plate Beyaz Ø 21 mm White Ø 21 mm
	AND.MED. ÇØ21K	Çukur Yemek Tabağı Kapağı Hot Dish Plate Lid

	AND.MED. DØ19T	Düz Pilav Tabağı Flat Rice Plate Beyaz Ø 19 mm White Ø19 mm
	AND.MED. DØ19K	Düz Pilav Tabağı Kapağı Flat Rice Plate Lid

Ürün Görseli Product Picture	Kod Code	Ürün Adı Description
	AND.MED. DØ17T	Düz Tatlı Tabağı Flat Desert Plate Beyaz Ø 17 mm White Ø17 mm
	AND.MED. DØ17K	Düz Tatlı Tabağı Kapağı Flat Desert Plate Lid

	AND.MED. S12x17T	Salata Kasesi Salad Plate Beyaz R12*17 mm White R12*17 mm
	AND.MED. S12x17K	Salata Kasesi Kapağı Salad Plate Lid

	AND.MED. KTØ23T	Bölmeli Kahvaltı Tabağı Divided Breakfast Plate Beyaz Ø23 mm White Ø23 mm
	AND.MED. KTØ23K	Bölmeli Kahvaltı Tabağı Kapağı Divided Breakfast Plate Lid

Taşıma Ekipmanları Carrying Equipment

Termobox Termobox

andora



Kod Code	Ürün Adı Description	İç Ebatlar Internal Dimension	Dış Ebatlar External Dimension	Ağırlık Weight	Kapasite Capacity
		a x b x c (mm)	a x b x c (mm)	(kg)	(lt)
AND.BOX-S	Termobox 1/2 Gn Thermobox 1/2 Gn	330x275x355	425x375x495	4.9 (± 200 gr)	19.5

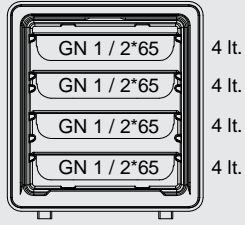

TOPLAM/TOTAL 16 lt.

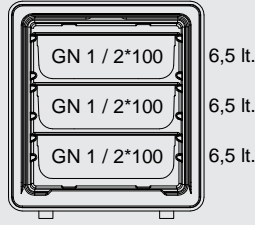

TOPLAM/TOTAL 19,5 lt.

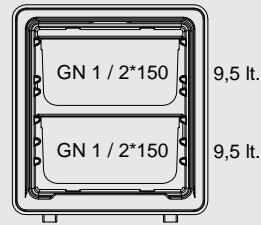

TOPLAM/TOTAL 19 lt.

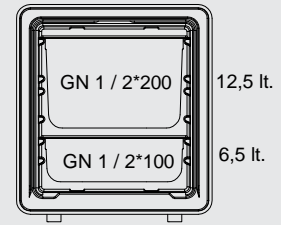

TOPLAM/TOTAL 19 lt.



Kod Code	Ürün Adı Description	İç Ebatlar Internal Dimension	Dış Ebatlar External Dimension	Ağırlık Weight	Kapasite Capacity
		a x b x c (mm)	a x b x c (mm)	(kg)	(lt)
AND.BOX-600	Termobox 600 Thermobox 600	335x533x500	450x635x575	9.3 (± 200 gr)	83



AND.BOX-600-K



AND.BOX-600-K-I

Kod Code	Ürün Adı Description	İç Ebatlar Internal Dimension	Dış Ebatlar External Dimension	Ağırlık Weight	Kapasite Capacity
		a x b x c (mm)	a x b x c (mm)	(kg)	(lt)
AND.BOX-600-K	Termobox 600 Mentешeli Thermobox 600 Side-Hinged	335x533x500	465x635x575	10.2 (± 200 gr)	83
AND.BOX-600-K-I	Termobox 600 Mentешeli (Isıtmalı) Thermobox 600 Side-Hinged (with Heated)	335x533x500	465x655x575	14.5 (± 200 gr)	83

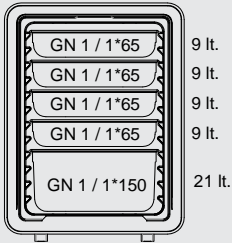

TOPLAM/TOTAL 57 lt.

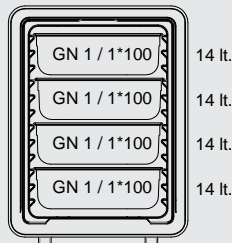

TOPLAM/TOTAL 56 lt.

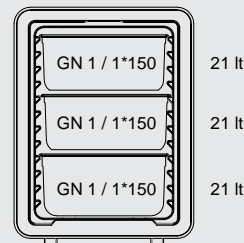

TOPLAM/TOTAL 63 lt.

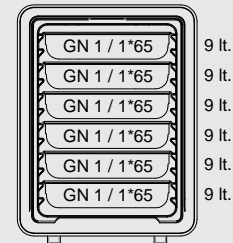

TOPLAM/TOTAL 54 lt.

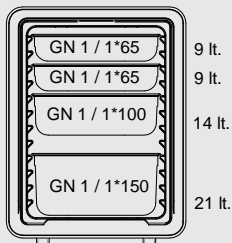

TOPLAM/TOTAL 53 lt.

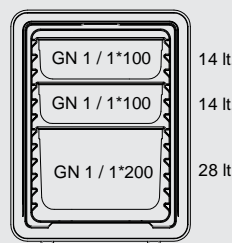

TOPLAM/TOTAL 56 lt.

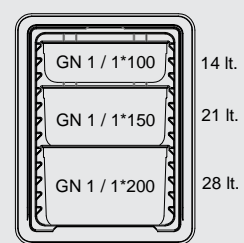

TOPLAM/TOTAL 63 lt.

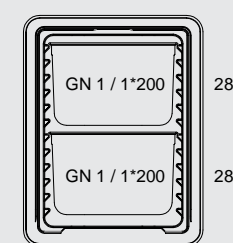

TOPLAM/TOTAL 56 lt.

60x40 Tepsi / Tray



AND.BOX-700



AND.BOX-700-I

Kod Code	Ürün Adı Description	İç Ebatlar Internal Dimension	Dış Ebatlar External Dimension	Ağırlık Weight	Kapasite Capacity
		a x b x c (mm)	a x b x c (mm)	(kg)	(lt)
AND.BOX-700	Termobox 700 Menteşeli Termobox 700 Side-Hinged	410x610x550	565x720x670	14.2 (± 200 gr)	140
AND.BOX-700-I	Termobox 700 Menteşeli (Isıtmalı) Termobox 700 Side-Hinged (with Heated)	410x610x550	565x740x670	18.5 (± 200 gr)	140

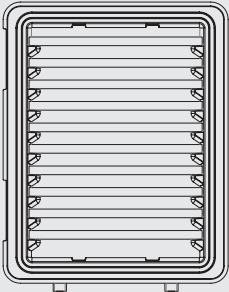

40x60 TEPSİ/TRAY
10 ADET/PIECES



AND.BOX-800



AND.BOX-800-I

Kod Code	Ürün Adı Description	İç Ebatlar Internal Dimension	Dış Ebatlar External Dimension	Ağırlık Weight	Kapasite Capacity
		a x b x c (mm)	a x b x c (mm)	(kg)	(lt)
AND.BOX-800	Termobox 800 Thermobox 800	535x670x500	670x765x615	15.8 (± 200 gr)	180
AND.BOX-800-I	Termobox 800 (Isıtmalı) Thermobox 800 (with Heated)	535x670x500	670x785x615	20 (± 200 gr)	180

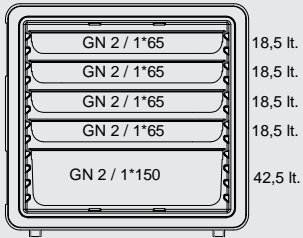

TOPLAM/TOTAL 116,5 lt.

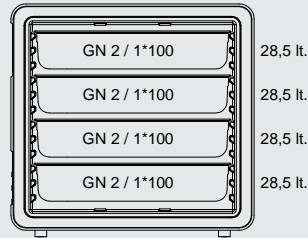

TOPLAM/TOTAL 114 lt.

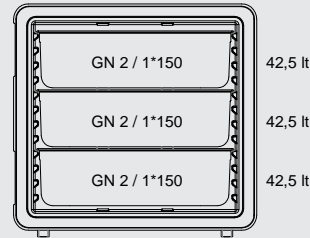

TOPLAM/TOTAL 127,5 lt.



TOPLAM/TOTAL 111 lt.

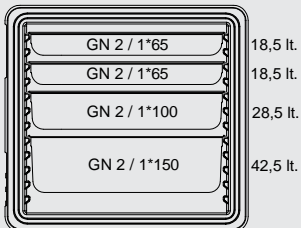

TOPLAM/TOTAL 108 lt.

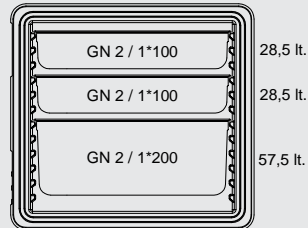

TOPLAM/TOTAL 114,5 lt.

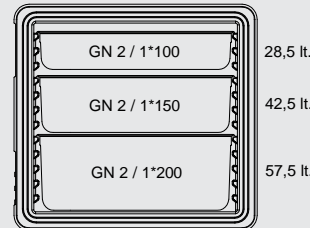

TOPLAM/TOTAL 128,5 lt.

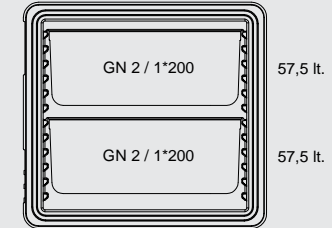

TOPLAM/TOTAL 115 lt.

Taşıma Ekipmanları Carrying Equipment

Termobox
Termobox

andora



AND.BOX-800+800

AND.BOX-800+800-I

Kod Code	Ürün Adı Description	İç Ebatlar Internal Dimension	Dış Ebatlar External Dimension	Ağırlık Weight	Kapasite Capacity
		a x b x c (mm)	a x b x c (mm)	(kg)	(lt)
AND.BOX-800+800	Termobox 800+800 Thermobox 800+800	535x655x500	758x765x1375	42 (± 200 gr)	2x180
AND.BOX-800+800-I	Termobox 800+800 (Isıtmalı) Thermobox 800+800 (with Heated)	535x655x500	758x785x1375	50 (± 200 gr)	2x180

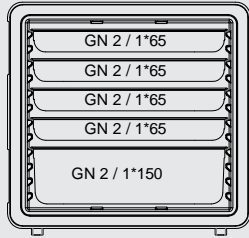

18,5 lt.
18,5 lt.
18,5 lt.
18,5 lt.
42,5 lt.

TOPLAM/TOTAL 116,5 lt.

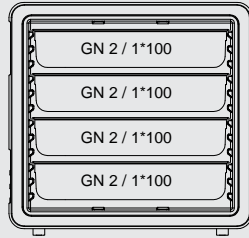

28,5 lt.
28,5 lt.
28,5 lt.
28,5 lt.

TOPLAM/TOTAL 114 lt.

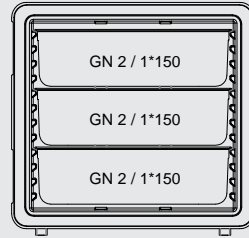

42,5 lt.
42,5 lt.
42,5 lt.

TOPLAM/TOTAL 127,5 lt.



18,5 lt.
18,5 lt.
18,5 lt.
18,5 lt.
18,5 lt.
18,5 lt.

TOPLAM/TOTAL 111 lt.



18,5 lt.
18,5 lt.
28,5 lt.
42,5 lt.

TOPLAM/TOTAL 108 lt.

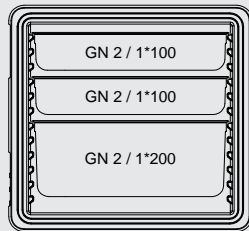

28,5 lt.
28,5 lt.
57,5 lt.

TOPLAM/TOTAL 114,5 lt.

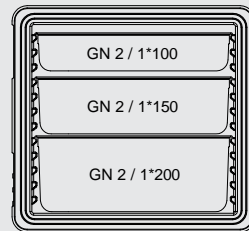

28,5 lt.
42,5 lt.
57,5 lt.

TOPLAM/TOTAL 128,5 lt.

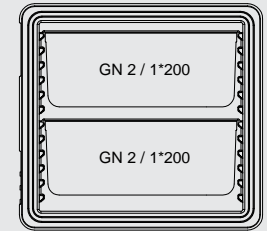

57,5 lt.
57,5 lt.

TOPLAM/TOTAL 115 lt.



AND.BOX-200



AND.BOX-300

Kod Code	Ürün Adı Description	İç Ebatlar Internal Dimension	Dış Ebatlar External Dimension	Ağırlık Weight	Kapasite Capacity
		a x b x c (mm)	a x b x c (mm)	(kg)	(lt)
AND.BOX-200	Termobox 200 Thermobox 200	535x335x146	616x422x305	6 (± 200 gr)	26
AND.BOX-300	Termobox 300 Thermobox 300	535x335x246	616x422x405	8 (± 200 gr)	48

AND.BOX-200

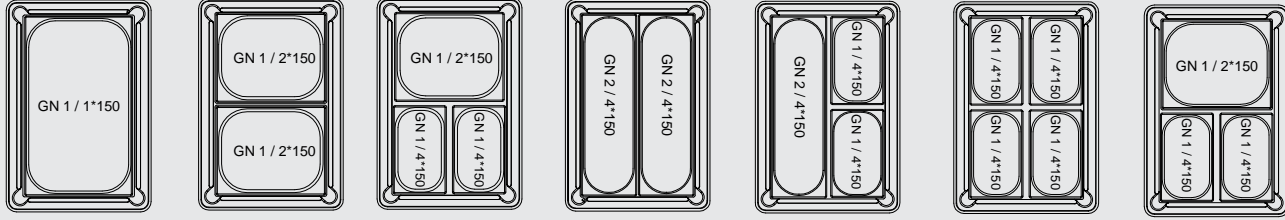

AND.BOX-300

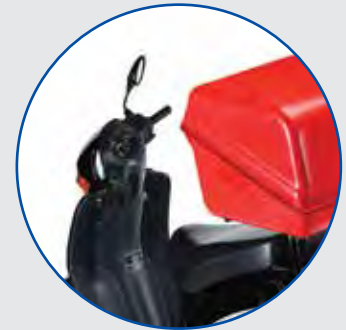
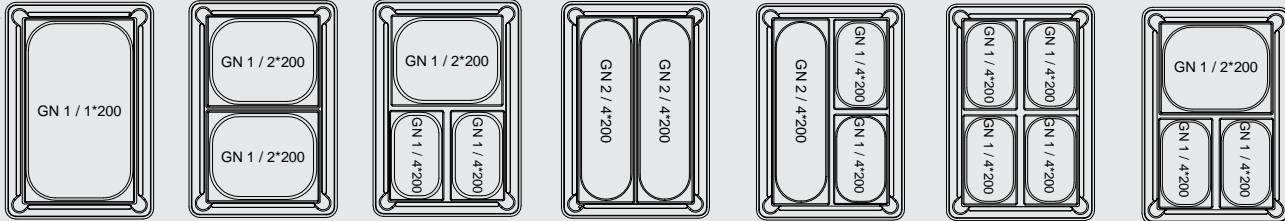

Kod Code	Ürün Adı Description	İç Ebatlar Internal Dimension	Dış Ebatlar External Dimension	Ağırlık Weight	Kapasite Capacity
		a x b x c (mm)	a x b x c (mm)	(kg)	(lt)
AND.MOB-0	Pizzabox Pizzabox	460x490x360	560x615x415	7.2 (± 200 gr)	70

Taşıma Ekipmanları Carrying Equipment

Epp Carrybox Epp Carrybox

andora



Kod Code	Ürün Adı Description	İç Ebatlar Internal Dimension	Dış Ebatlar External Dimension	Ağırlık Weight	Kapasite Capacity
		a x b x c (mm)	a x b x c (mm)	(kg)	(lt)
AND.EPP.600	Epp Carrybox 600 Epp Carrybox 600	330x530x525	440x645x630	3.8	92

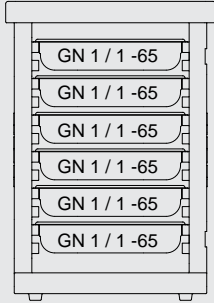

51 L
GN 1 / 1 -65 x 6 Adet

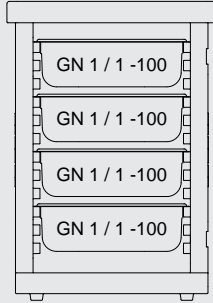

52,5 L
GN 1 / 1 -100 x 4 Adet

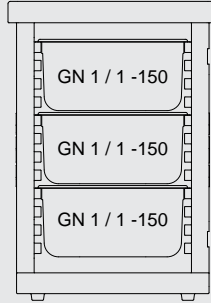

58,5 L
GN 1 / 1 -150 x 3 Adet

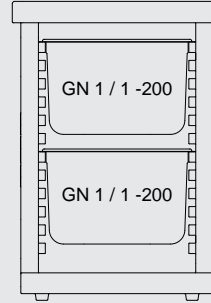

51 L
GN 1 / 1 -200 x 2 Adet



Kod Code	Ürün Adı Description	İç Ebatlar Internal Dimension	Dış Ebatlar External Dimension	Ağırlık Weight	Kapasite Capacity
		a x b x c (mm)	a x b x c (mm)	(kg)	(lt)
AND.EPP.700	Epp Carrybox 700 Epp Carrybox 700	410x615x585	535x770x689	6.5	147

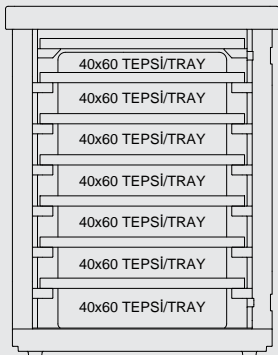

40x60 TEPSI/TRAY x 7 Adet/Pieces



AND.PİZ.35-4



AND.EPP.MOB



AND.EPP.MOB-F

Kod Code	Ürün Adı Description	İç Ebatlar Internal Dimension	Dış Ebatlar External Dimension	Ağırlık Weight	Kapasite Capacity
		a x b x c (mm)	a x b x c (mm)	(kg)	(lt)
AND.EPP.MOB	Epp Carrybox Epp Carrybox	491x420x508	602x570x575	4.4	100
AND.EPP.MOB-F	Epp Carrybox Full Epp Carrybox Full	491x420x508	602x570x575	5.4	100



Kod Code	Ürün Adı Description	İç Ebatlar Internal Dimension	Dış Ebatlar External Dimension	Ağırlık Weight	Kapasite Capacity
		a x b x c (mm)	a x b x c (mm)	(kg)	(lt)
AND.EPP.GN.1.1-200	Epp Carrybox 1/1 Gn Epp Carrybox 1/1 Gn	338x538x253	400x600x317	1.2	46

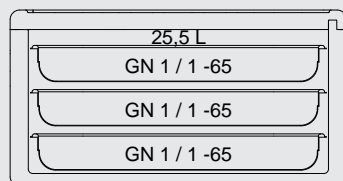
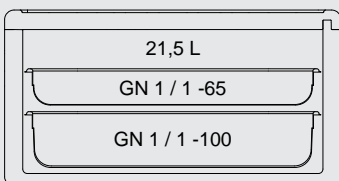
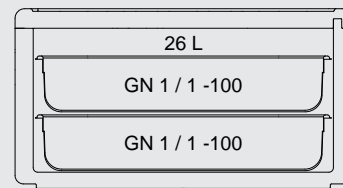
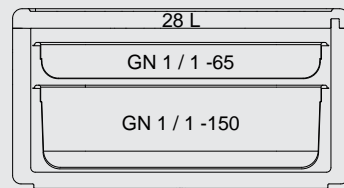
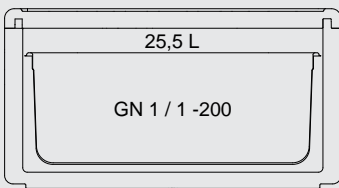

60x40 Tepsi / Tray



Kod Code	Ürün Adı Description	İç Ebatlar Internal Dimension	Dış Ebatlar External Dimension	Ağırlık Weight	Kapasite Capacity
		a x b x c (mm)	a x b x c (mm)	(kg)	(lt)
AND.EPP.TR60.40.20	Epp Carrybox 60x40x20 Epp Carrybox 60x40x20	425x625x205	490x690x269	1.3	53
AND.EPP.TR60.40.30	Epp Carrybox 60x40x30 Epp Carrybox 60x40x30	425x625x305	490x690x369	1.6	81



Kod Code	Ürün Adı Description	İç Ebatlar Internal Dimension	Dış Ebatlar External Dimension	Ağırlık Weight	Kapasite Capacity
		a x b x c (mm)	a x b x c (mm)	(kg)	(lt)
AND.PİZ.35-4	Epp Carrybox 4 PizzaxØ 35 cm Epp Carrybox 4 PizzaxØ 35 cm	350x365x175	410x425x235	0.70	22
AND.PİZ.35-8	Epp Carrybox 8 PizzaxØ 35 cm Epp Carrybox 8 PizzaxØ 35 cm	350x365x335	410x425x395	1	43
AND.PİZ.40-4	Epp Carrybox 4 PizzaxØ 40 cm Epp Carrybox 4 PizzaxØ 40 cm	420x420x175	480x480x245	1	31
AND.PİZ.40-8	Epp Carrybox 8 PizzaxØ 40 cm Epp Carrybox 8 PizzaxØ 40 cm	420x420x335	480x480x405	1.3	59

Kod Code	Ürün Adı Description	Ebatlar Dimension	Net Net
		a x b x c (mm)	(m ³)
AND.TRBAG.01	Thermo Küçük Pizza Çanta Thermo Small Pizza Delivery Bag	350x350x200	0.03



Kod Code	Ürün Adı Description	Ebatlar Dimension	Net Net
		a x b x c (mm)	(m ³)
AND.TRBAG.02	Thermo Orta Pizza Servis Çantası Thermo Medium Pizza Delivery Bag	400x400x200	0.04



Kod Code	Ürün Adı Description	Ebatlar Dimension	Net Net
		a x b x c (mm)	(m ³)
AND.TRBAG.03	Thermo Büyük Pizza Servis Çantası Thermo Big Pizza Delivery Bag	450x450x200	0.04



Kod Code	Ürün Adı Description	Ebatlar Dimension	Net Net
		a x b x c (mm)	(m ³)
AND.TRBAG.04	Thermo Cepli Pizza Servis Çantası Thermo Pizza Delivery Bag (With Pocket)	350x450x200	0.03



Taşıma Ekipmanları Carrying Equipment

Servis Çantaları Delivery Bags

andora



Kod Code	Ürün Adı Description	Ebatlar Dimension	Net Net
		a x b x c (mm)	(m ³)
AND.TRBAG.05	Thermo Pide Servis Çantası Thermo Turkish Pizza Delivery Bag	520x230x15	0.02



Kod Code	Ürün Adı Description	Ebatlar Dimension	Net Net
		a x b x c (mm)	(m ³)
AND.TRBAG.06	Thermo Kare Servis Çantası Thermo Square Delivery Bag	380x380x250	0.03



Kod Code	Ürün Adı Description	Ebatlar Dimension	Net Net
		a x b x c (mm)	(m ³)
AND.TRBAG.07	Thermo Dikdörtgen Servis Çantası Thermo Rectangle Delivery Bag	350x230x230	0.02



Kod Code	Ürün Adı Description	Ebatlar Dimension	Net Net
		a x b x c (mm)	(m ³)
AND.TRBAG.08	Thermo Büyük Servis Çantası Thermo Big Delivery Bag	500x360x240	0.04

Plastik Servis Arabalar
Plastic Service Trolleys

Taşıma Ekipmanları
Carrying Equipment



Kod Code	Ürün Adı Description	Ebatlar Dimension	Ağırlık Weight
		a x b x c (mm)	(kg)
AND.PSV.03-K	Plastik Kapalı Servis Arabası 3 Katlı Plastic Service Trolley 3 Tiers	500x800x970	14
AND.CK.01-P	Plastik Çöp Aparatı Plastic Trash Apparatus	330x225x560	1.7
AND.CK.02-P	Plastik Kaşık Aparatı Plastic Spoon Apparatus	330x230x175	0.75
AND.YK.01	Monoblok Kapaklar Monoblock Covers		



Kod Code	Ürün Adı Description	Ebatlar Dimension	Ağırlık Weight
		a x b x c (mm)	(kg)
AND.PSV.02	Plastik Servis Arabası 2 Katlı Plastic Service Trolley 2 Tiers	500x800x970	8.1
AND.PSV.03	Plastik Servis Arabası 3 Katlı Plastic Service Trolley 3 Tiers	500x800x970	11

Taşıma Ekipmanları Carrying Equipment

Servis Arabaları Service Trolleys

andora



Pres baskılı tabla / Pressed stainless steel table

Kod Code	Ürün Adı Description	Ebatlar Dimension a x b x c (mm)	Ağırlık Weight (kg)
AND.2.SV.02	Paslanmaz Servis Arabası 2 Katlı Service Trolley 2 Tiers	550x860x900	15
AND.2.SV.03	Paslanmaz Servis Arabası 3 Katlı Service Trolley 3 Tiers	550x860x900	20



Tepsi fiyata dahildir. / Tray is included

Kod Code	Ürün Adı Description	Ebatlar Dimension a x b x c (mm)	Ağırlık Weight (kg)
AND.MS.01	Plastik Mama Sandalyesi Plastic Baby Feeding Chair	600x600x750	6.5



AND.AYK.002

AND.DKE.50-T

Kod Code	Ürün Adı Description	Ebatlar Dimension	Ağırlık Weight	Net Net
		a x b x c (mm)	(kg)	(m ³)
AND.AYK.002	Ayaktan Kumandalı El Yıkama Evyesi Foot Operated Hand Wash Sink	500x450x850/1350	22	0.30
AND.DKE.50-T	Ayaktan Kumandalı Mobil El Yıkama Evyesi Foot Operated Mobile Hand Wash Sink	500x655x900/1400	25	0.45

TEKNİK ÖZELLİKLER

- Paslanmaz çelik gövde.
- Modern tasarım.
- Hızlı ve kolay kurulum.
- Hijyenik kapalı çöp kabini.
- Ayaktan kumandalı su akım sistemi.
- Z tipi peçetelik.
- Dirsekten kumandalı sıvı sabunluk.

AND.DKE.50-T

- Mobil taşınabilir sistem.
- Temiz Su Tankı: 30 lt
- Pis Su Tankı: 30 lt

TECHNICAL SPECIFICATIONS

- Stainless steel body.
- Contemporary design.
- Quick and easy set-up.
- Hygienic, closed trash bin.
- Foot operated Push-Pull water flow system.
- Z type napkin holder.
- Elbow operated soap dispenser.

AND.DKE.50-T

- Mobile system.
- Fresh Water Tank: 30 lt
- Waste Tank: 30 l



AND.DKE.50-T

Taşıma Ekipmanları Carrying Equipment

Elektrikli Mobil Dezenfektan İstasyonu Electrical Mobile Disinfection Station

andora



AND.DKE.75



AND.DKE.102

Kod Code	Ürün Adı Description	Ebatlar Dimension	Ağırlık Weight	Net Net	Güç Power
		a x b x c (mm)	(kg)	(m ³)	(kw)
AND.DKE.75	Elektrikli Mobil Dezenfektan İstasyonu Electrical Mobile Disinfection Station	750x605x875/1590	44	0.72	0.22
AND.DKE.102	Elektrikli Mobil Dezenfektan İstasyonu Electrical Mobile Disinfection Station	1020x605x875/1590	87	0.98	0.22

TEKNİK ÖZELLİKLER

- Paslanmaz çelik gövde.
- Modern tasarım.
- Hızlı ve kolay kurulum.
- Ayaktan kumanda elektrikli su akım sistemi.
- Mobil taşınabilir su tank sistemi.
- Z tipi peçetelik.
- Dirsekten kumandalı dezenfektan.
- Dirsekten kumandalı sıvı sabunluk.
- Mobil taşınabilir sistem.
- Temiz Su Tankı: 30 lt
- Pis Su Tankı: 30 lt
- 220V 50-60 Hz çalışma aralığı.

TECHNICAL SPECIFICATIONS

- Stainless steel body.
- Contemporary design.
- Quick and easy set-up.
- Foot operated electrical water flow system.
- Mobile water tank system.
- Z type napkin holder.
- Elbow operated disinfectant.
- Elbow operated soap dispenser.
- Mobile system.
- Fresh Water Tank: 30 lt
- Waste Tank: 30 lt
- 220V 50-60 Hz operating range.



Temiz su ve pis su tankı
Fresh and waste water tank



DEMONTE



AND.DKE.007

AND.DKE.008

Kod Code	Ürün Adı Description	Ebatlar Dimension	Ağırlık Weight	Net Net
		a x b x c (mm)	(kg)	(m ³)
AND.DKE.007	Dezenfektan İstasyonu Dirsekten Kumandalı 1 lt Elbow Operated Disinfection Station 1 lt	200x60x1445	12	0.17
AND.DKE.008	Dezenfektan İstasyonu Dirsekten Kumandalı 2.5 lt Elbow Operated Disinfection Station 2.5 lt	200x60x1445	12	0.17

DEMONTE



AND.AYK.001

AND.AYK.004

AND.AYK.003

Kod Code	Ürün Adı Description	Ebatlar Dimension	Ağırlık Weight	Net Net
		a x b x c (mm)	(kg)	(m ³)
AND.AYK.001	Dezenfektan İstasyonu Ayaktan Kumandalı 1 lt Foot Operated Disinfection Station 1 lt	200x167x1125	11	0.037
AND.AYK.004	Dezenfektan İstasyonu Ayaktan Kumandalı 2.5 lt Foot Operated Disinfection Station 2.5 lt	200x167x1125	11	0.037
AND.AYK.003	Dezenfektan İstasyonu Ayaktan Kumandalı 5/10 lt Foot Operated Disinfection Station 5/10 lt	300x440x1212	17	0.16

Taşıma Ekipmanları Carrying Equipment

Mutfak Bulaşık Arabaları Kitchen Trolleys

andora



Kod Code	Ürün Adı Description	Ebatlar Dimension
		a x b x c (mm)
AND.TT.2.7050	Tepsi Taşıma Arabası 50x70 Tepsiye Göre Tray Trolley For 50x70 Tray	560x730x1700



Kod Code	Ürün Adı Description	Ebatlar Dimension	Kapasite Capacity
		a x b x c (mm)	basket adet
AND.BAKA.2.5	Basket Taşıma Arabası Alçak Basket Trolley With Rails Low	560x530x900	5
AND.BAKY.2.10	Basket Taşıma Arabası Yüksek Basket Trolley With High	560x530x1650	10

- Paslanmaz Çelik. / Stainless Steel.



Kod Code	Ürün Adı Description	Ebatlar Dimension	Kapasite Capacity
		a x b x c (mm)	(tepsi/tray)
AND.BA.2.3753-13	Bulaşık Toplama Arabası Selfrom 37x53 Tekli Tray Trolley with Rails Single Row For 37x53	430x560x1710	13-15
AND.BA.2.3753-26	Bulaşık Toplama Arabası Selfrom 37x53 İkili Tray Trolley with Rails Twin Row For 37x53	830x560x1710	26-30
AND.BA.2.3753-39	Bulaşık Toplama Arabası Selfrom 37x53 Üçlü Tray Trolley with Rails Triple Row For 37x53	1230x560x1710	39-45



Kod Code	Ürün Adı Description	Ebatlar Dimension	Kapasite Capacity
		a x b x c (mm)	(gn 1/1)
AND.BA.2.GN-9	Gn Küvet Taşıma Arabası Alçak Tekli 1/1 Gn Gn Trolley Low Single 1/1 Gn	380x560x1050	9
AND.BA.2.GN-17	Gn Küvet Taşıma Arabası Yüksek Tekli 1/1 Gn Gn Trolley High Single 1/1 Gn	380x560x1720	17
AND.BA.2.GN-34	Gn Küvet Taşıma Arabası Yüksek İkili 1/1 Gn Gn Trolley High Twin 1/1 Gn	740x560x1720	34

- Paslanmaz Çelik. / Stainless Steel.



Kod Code	Ürün Adı Description	Ebatlar Dimension	Kapasite Capacity
		a x b x c (mm)	(gn 2/1)
AND.BA.2.GN2-9	Tepsi Taşıma Arabası Alçak Tekli 2/1 Gn Gn Trolley Low Single 2/1 Gn	590x680x1050	9
AND.BA.2.GN2-17	Tepsi Taşıma Arabası Yüksek Tekli 2/1 Gn Gn Trolley High Single 2/1 Gn	590x680x1720	17
AND.BA.2.GN2-34	Tepsi Taşıma Arabası Yüksek İkili 2/1 Gn Gn Trolley High Twin 2/1 Gn	1150x680x1720	34

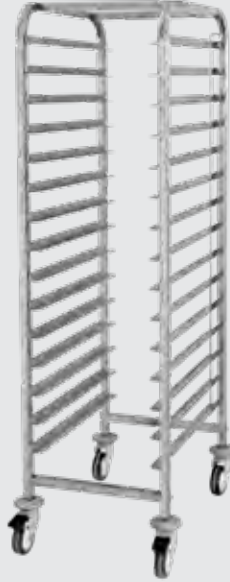

Kod Code	Ürün Adı Description	Ebatlar Dimension	Kapasite Capacity
		a x b x c (mm)	(tepsi/tray)
AND.TT.2.6040	Tepsi Taşıma Arabası 40x60 Tepsiye Göre Tekli Tray Trolley For 40x60 Tray Single	460x630x1650	15
AND.2TT.2.6040	Tepsi Taşıma Arabası 40x60 Tepsiye Göre İkili Tray Trolley For 40x60 Tray Twin	900x630x1650	30

- Paslanmaz Çelik. / Stainless Steel.



Kod Code	Ürün Adı Description	Ebatlar Dimension
		a x b x c (mm)
AND.BAH.2.8555-90	Bulaşık Toplama Arabası Havuzlu Tray Clearing Trolley	850x550x900



Kod Code	Ürün Adı Description	Ebatlar Dimension
		a x b x c (mm)
AND.BAKT.2.5555-90	Basket Taşıma Arabası Basket Trolley	550x550x900

Taşıma Ekipmanları Carrying Equipment

Taşıma ve Muhafaza Arabaları Mobile Storage Bins and Transport Carts

andora



Kod Code	Ürün Adı Description	Ebatlar Dimension
		a x b x c (mm)
AND.BAKTT.2.906050-90	Kazan ve Tencere Taşıma Arabası Pot Trolley	900x600x500/900



Kod Code	Ürün Adı Description	Ebatlar Dimension
		a x b x c (mm)
AND.TA.2.1055-17	Et Askı Arabası Carcass Hanger	1000x550x1700
AND.TA.2.1255-17	Et Askı Arabası Carcass Hanger	1200x550x1700
AND.TA.2.1555-17	Et Askı Arabası Carcass Hanger	1500x550x1700



Kod Code	Ürün Adı Description	Ebatlar Dimension
		a x b x c (mm)
AND.PD.2.806020-90	Düz Platform Taşıma Arabası Solid Platform Trolley	800x600x200 / 900

- Paslanmaz Çelik. / Stainless Steel.



Kod Code	Ürün Adı Description	Ebatlar Dimension a x b x c (mm)	Tipi Type
AND.CY.01	Yuvarlak Çöp Arabası Mobile Waste Bin-Round	∅ 400x400	Inox 304

- Pres Baskı / Pressed



Kod Code	Ürün Adı Description	Ebatlar Dimension a x b x c (mm)	Tipi Type
AND.CK.01	Çöp Arabası Kare Mobile Waste Bin-Square	500x550x500	Inox 304

- Pres Baskı / Pressed



Kod Code	Ürün Adı Description	Ebatlar Dimension a x b x c (mm)	Tipi Type
AND.ECK.3.8454-58	Çift Kapaklı Erzak Arabası Mobile Bin Double Lid	840x540x580	Inox 304

- Pres Baskı / Pressed



Kod Code	Ürün Adı Description	Ebatlar Dimension	Kapasite Capacity
		a x b x c (mm)	tabak/plate
AND.TO.1826-N-1	Tekli Tabak Otomatı Single Plate Dispenser	Nötr / Neutral 440x500x900	18/26
AND.TO.1826-I-1	Tekli Tabak Otomatı Single Plate Dispenser	Isıtımlı / Heating 440x500x900	18/26
AND.TO.2432-N-1	Tekli Tabak Otomatı Single Plate Dispenser	Nötr / Neutral 480x550x900	24/32
AND.TO.2432-I-1	Tekli Tabak Otomatı Single Plate Dispenser	Isıtımlı / Heating 480x550x900	24/32



Kod Code	Ürün Adı Description	Ebatlar Dimension	Kapasite Capacity
		a x b x c (mm)	tabak/plate
AND.TO.1826-N-2	Çiftli Tabak Otomatı Double Plate Dispenser	Nötr / Neutral 440x880x900	18/26
AND.TO.1826-I-2	Çiftli Tabak Otomatı Double Plate Dispenser	Isıtımlı / Heating 440x880x900	18/26
AND.TO.2432-N-2	Çiftli Tabak Otomatı Double Plate Dispenser	Nötr / Neutral 480x1000x900	24/32
AND.TO.2432-I-2	Çiftli Tabak Otomatı Double Plate Dispenser	Isıtımlı / Heating 480x1000x900	24/32

- Paslanmaz Çelik. / Stainless Steel.



Kod Code	Ürün Adı Description	Ebatlar Dimension	Kapasite Capacity
		a x b x c (mm)	tabak/plate
AND.TO.1826-N	Tabak Kartuşu Plate Dispensing Cartridge	Nötr / Neutral 380x380x750	18/26
AND.TO.1826-I	Tabak Kartuşu Plate Dispensing Cartridge	Isıtmalı / Heating 380x380x750	18/26
AND.TO.2432-N	Tabak Kartuşu Plate Dispensing Cartridge	Nötr / Neutral 440x440x750	24/32
AND.TO.2432-I	Tabak Kartuşu Plate Dispensing Cartridge	Isıtmalı / Heating 440x440x750	24/32

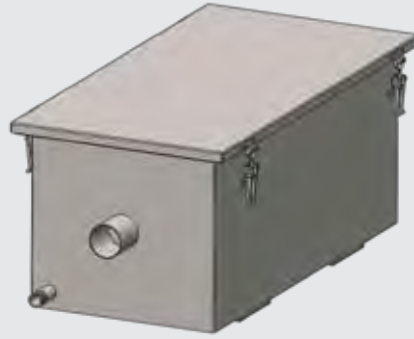

Kod Code	Ürün Adı Description	Ebatlar Dimension	Ağırlık Weight	Kapasite Capacity
		a x b x c (mm)	(kg)	(lt)
AND.YT.01	Yağ Ayırıcı Grease Separator	655x340x290	20	10
AND.YT.02	Yağ Ayırıcı Grease Separator	730x413x420	29	16
AND.YT.03	Yağ Ayırıcı Grease Separator	900x540x640	52	50

Taşıma Ekipmanları Carrying Equipment

Oda Servis Üniteleri Hotel Service Units

andora



Kod Code	Ürün Adı Description	Ebatlar Dimension	Ağırlık Weight	Net Net
		a x b x c (mm)	(kg)	(m ³)
AND.MBQ.01	Isıtmalı Mini Servis Basket Room Service Hot Box	420x435x515	20	0.1



AND.OKS.01



AND.OSA.01



Kod Code	Ürün Adı Description	Ebatlar Dimension	Ağırlık Weight	Net Net
		a x b x c (mm)	(kg)	(m ³)
AND.OKS.01	Otel Kat Isıtma Arabası Hot Box Heating Rack	1070x530x1400	23	0.80
AND.OSA.01	Oda Servis Masası (Katlanır) Room Service Desk (Foldable)	930x910x750	12	0.64

Cafe Bar Ekipmanları

Cafe Bar Equipment



andora

andora

CAFE BAR EKİPMANLARI

Otomatik Portakal Sıkma Makineleri
Şerbet ve Ayran Makineleri
Köpüklü Ayran Makineleri
Capuccino Espresso Makineleri
Otomatik Capuccino Espresso Makineleri
Kahve Makineleri
Türk Kahve Makineleri
Demlikli Çay Otomatları
Çay ve Su Otomatları
Gazlı Döner Ocakları (Üstten Motorlu)
Gazlı Döner Ocakları (Alttan Motorlu)
Elektrikli Camlı Döner Ocakları (Alttan Motorlu)
Gazlı Camlı Döner Ocakları (Alttan Motorlu)
Gazlı Döner Ocakları V Tip (Alttan Motorlu)
Tost Makineleri (Elektrikli)
Krep ve Waffle Makineleri
Elektrikli Salamander Izgaralar
Gazlı Salamander Izgaralar
Sıcak Teşhir Üniteleri (Halogen Isıtıcı)
Ekmek Kızartma Makineleri ve Kuruyemiş Çekmeceleri

CAFE BAR EQUIPMENT

Automatic Orange Juicers
Juicers and Ayran Makers
Sparkling Ayran Makers
Cappucino Espresso Machines
Automatic Cappucino Espresso Machines
Coffee Grinders
Turkish Coffee Machines
Tea Maker with Pots
Tea Makers and Hot Water Dispensers
Gas Shawarma Machines (Motor on Top)
Gas Shawarma Machines (Motor at Bottom)
Electrical Robax Glass Shawarma Machines (Motor at Bottom)
Gas Robax Glass Shawarma Machines (Motor at Bottom)
Gas Shawarma Machines V Type (Motor at Bottom)
Toaster (Electrical)
Crepe and Waffle Makers
Electrical Salamander Grills
Gas Salamander Grills
Hot Display Units (Halogen Lamp)
Conveyor Toasters and Nuts Units



Kod Code	Ürün Adı Description	Ebatlar Dimension	Ağırlık Weight	Net Net	Kapasite Capacity
		a x b x c (mm)	(kg)	(m ³)	(adet/dk pcs/min)
AND.ORG.50-T	Otomatik Portakal Sıkma Makinesi (Turuncu Renk) Automatic Orange Juicer (Orange Color)	420x578x910	68	0.22	24
AND.ORG.51-T	Alt Stand (Turuncu Renk) Bottom Stand (Orange Color)	470x578x800	21	0.22	
AND.ORG.50-G	Otomatik Portakal Sıkma Makinesi (Gri Renk) Automatic Orange Juicer (Gray Color)	420x578x910	68	0.22	24
AND.ORG.51-G	Alt Stand (Gri Renk) Bottom Stand (Gray Color)	470x578x800	21	0.22	

TEKNİK ÖZELLİKLER

- 0.37 kW 1500 D/Dk 220 - 240V 50-60 Hz motor gücü.
- Güvenlik sensörü.
- Tek seferde 18 kg yükleme kapasitesi.
- 60-85 mm portakal çapı.
- 2 farklı renk seçeneği.
- Besleyici kapasitesi 12 kg
- Kolay sökülüp yıkanabilir sıkıcı sistemi.

TECHNICAL SPECIFICATIONS

- Motor power: 0.37 kW 1500 rpm 220 - 240V 50-60 Hz
- Safety sensor.
- Loading capacity: 18 kg/time.
- Orange diameter: 60-85 mm
- 2 different color options.
- Feeder capacity 12 kg
- Easily removable and washable hole punching system.



Cafe Bar Ekipmanları Cafe Bar Equipment

Şerbet ve Ayrın Makineleri Juicers and Ayrın Makers

andora



Kod Code	Ürün Adı Description	Ebatlar Dimension	Ağırlık Weight	Net Net	Kapasite Capacity
		a x b x c (mm)	(kg)	(m ³)	(lt)
AND.SY.19	Şerbet ve Ayrın Makinesi Juice and Ayrın Maker	320x400x700	20	0.09	19

TEKNİK ÖZELLİKLER

- 220V. 50 Hz. çalışma gücü.
- R134A Soğutucu gaz.
- Tabandan soğutma sistemi ile içeceği son damlasına kadar eşit olarak soğutma.
- Dijital termostat ve soğutma sistemi sayesinde %15 enerji tasarrufu.
- Dijital termostat kontrol.
- +3 ile +10 derece arasında sıcaklık.
- Su sızması ve motora su kaçma riski ortadan kaldıran manyetik karıştırma sistemi.
- Geniş musluk hortumu.
- Düşük çalışma ses seviyesi.
- Hazne kapağının düz formu sayesinde bardaklık olarak kullanılabilme imkanı.
- İçecek ile temas eden tüm parçalar kolaylık çıkarılabilir ve temizlenebilir.

TECHNICAL SPECIFICATIONS

- 220V. 50 Hz operating power.
- R134A Refrigerant gas.
- Surface cooling system cools evenly until the last drop of drink.
- The digital thermostat and cooling system provides a 15% energy savings.
- It shows the current temperature of the drink with digital thermostat.
- Beverage temperature can be adjusted +3 and +10 degrees between.
- With one hand, the developed system makes it easier to tap beverage intake.
- With magnetic mixing system eliminates the risk of water leakage into the water leakage and engine.
- The low noise level of the class.
- Possibility to use the cup holder thanks to the flat form of the hopper cover.
- All parts in contact with the beverage removable and can be cleaned with ease.

Ahşap Kaplama
Wooden DecoratedPaslanmaz Çelik
Stainless Steel

Kod Code	Ürün Adı Description	Ebatlar Dimension	Ağırlık Weight	Net Net	Kapasite Capacity
		a x b x c (mm)	(kg)	(m ³)	(lt)
AND.AYR.40	Köpüklü Ayran Makinesi Ahşap Kaplamalı Sparkling Ayran Maker Wooden Decorated	660x600x1528	78	0.5	40
AND.AYR.40-P	Köpüklü Ayran Makinesi Paslanmaz Çelik Sparkling Ayran Maker Stainless Steel	660x600x1528	78	0.5	40

TEKNİK ÖZELLİKLER

- 220V / 50 Hz
- 200 Watt.
- 40 litre kapasiteli.
- Kazan temizlik ve tahliye vanası.
- Bardak doldurma musluğu ve alt süzgeci.
- Köpüklü veya köpüksüz ayran doldurma seçeneği.
- İç aydınlatmalı.

TECHNICAL SPECIFICATIONS

- 220V / 50 Hz
- 200 Watt.
- 40 lt.capacities.
- Tank cleaning and discharge valve.
- Glass filling sink and sub filter.
- Foomly or foomless yogurt drink options.
- Interior lighting.



Cafe Bar Ekipmanları Cafe Bar Equipment

Capuccino Espresso Makineleri Cappuccino Espresso Machines

andora



Kod Code	Ürün Adı Description	Ebatlar Dimension	Ağırlık Weight	Net Net	Güç Power	Kapasite Capacity
		a x b x c (mm)	(kg)	(m ³)	(kw)	(lt)
AND.CPC.1GR	Capuccino ve Espresso Makinesi 1 Gruplu Capuccino Espresso Machine 1 Group	410x590x610	27	0.14	2.5	4.6
AND.CPC.2GR	Capuccino ve Espresso Makinesi 2 Gruplu Capuccino Espresso Machine 2 Groups	811x600x628	67	0.30	4.5	11
AND.CPC.3GR	Capuccino ve Espresso Makinesi 3 Gruplu Capuccino Espresso Machine 3 Groups	1023x600x628	81	0.39	5	19



Kod Code	Ürün Adı Description	Ebatlar Dimension	Ağırlık Weight	Net Net	Güç Power	Kapasite Capacity
		a x b x c (mm)	(kg)	(m ³)	(kw)	(lt)
AND.CPC.1GB	Capuccino ve Espresso Makinesi 1 Gruplu Capuccino Espresso Machine 1 Group	410x590x610	27	0.14	2.5	4.6
AND.CPC.2GB	Capuccino ve Espresso Makinesi 2 Gruplu Capuccino Espresso Machine 2 Groups	811x600x628	67	0.30	4.5	11
AND.CPC.3GB	Capuccino ve Espresso Makinesi 3 Gruplu Capuccino Espresso Machine 3 Groups	1023x600x628	81	0.39	5	19

TEKNİK ÖZELLİKLER

- 230V çalışma gücü
- Çift buhar kolu.
- Dozaj ayar ünitesi.
- Ekstra sıcak su kolu.
- Yarı otomatik.

TECHNICAL SPECIFICATIONS

- 230V operating voltage.
- Double steam arm.
- Dosage adjustment unit.
- Extra-warm water arm.
- Semi automatic.



Kod Code	Ürün Adı Description	Ebatlar Dimension	Ağırlık Weight	Net Net	Güç Power	Kapasite Capacity
		a x b x c (mm)	(kg)	(m ³)	(kw)	(lt)
AND.CPC.2GR-D	Otomatik Capuccino Espresso Makineleri 2 Gruplu Automatic Cappuccino Espresso Machine 2 Group	811x600x628	67	0.30	4.5	11
AND.CPC.3GR-D	Otomatik Capuccino Espresso Makineleri 3 Gruplu Automatic Cappuccino Espresso Machine 3 Group	1023x600x628	81	0.39	5	19



Kod Code	Ürün Adı Description	Ebatlar Dimension	Ağırlık Weight	Net Net	Güç Power	Kapasite Capacity
		a x b x c (mm)	(kg)	(m ³)	(kw)	(lt)
AND.CPC.2GB-D	Otomatik Capuccino Espresso Makineleri 2 Gruplu Automatic Cappuccino Espresso Machine 2 Group	811x600x628	67	0.30	4.5	11
AND.CPC.3GB-D	Otomatik Capuccino Espresso Makineleri 3 Gruplu Automatic Cappuccino Espresso Machine 3 Group	1023x600x628	81	0.39	5	19

TEKNİK ÖZELLİKLER

- 380V çalışma gücü
- Çift buhar kolu.
- Dozaj ayar ünitesi.
- Ekstra sıcak su kolu.
- Tam otomatik dijital kontrollü

TECHNICAL SPECIFICATIONS

- 380V operating voltage.
- Double steam arm.
- Dosage adjustment unit.
- Extra-warm water arm.
- Full automatic digital board.

Cafe Bar Ekipmanları
Cafe Bar Equipment

Kahve Değirmenleri
Coffee Grinders

andora



Kod Code	Ürün Adı Description	Ebatlar Dimension	Ağırlık Weight	Net Net	Kapasite Capacity
		a x b x c (mm)	(kg)	(m ³)	(lt)
AND.CCG.01	Kahve Değirmeni Coffee Grinder	210x380x600	9	0.04	2
AND.KCM.01	Kahve Çekmecesi Coffee Drawer	410x490			

TEKNİK ÖZELLİKLER

- 230V - 356 W - 1.75 A
- Termal koruyuculu motor ekipmanı.
- Maksimum çalışma süresi 30 dk.
- Değirmen çapı 60 mm.
- Hazne kapasitesi 2 kg.
- Dispenser kapasitesi ortalama 2 kg.

TECHNICAL SPECIFICATIONS

- 230V - 356 W - 1.75 A
- Thermal motor protection equipment.
- Maximum operating time 30 minutes.
- Mill diameter of 60 mm
- Bin capacity 2 kg
- Dispenser average of 2 kg capacity.

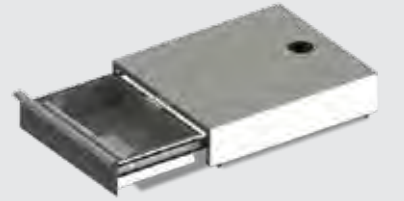



Kod Code	Ürün Adı Description	Ebatlar Dimension	Ağırlık Weight	Net Net	Güç Power
		a x b x c (mm)	(kg)	(m ³)	(kw)
AND.LC2	Türk Kahve Makinesi 2 Cezveli Turkish Coffee Machine 2 Coffee Pots	340x365x405		0.05	1.3
AND.LC3	Türk Kahve Makinesi 3 Cezveli Turkish Coffee Machine 3 Coffee Pots	500x365x405		0.08	1.8

TEKNİK ÖZELLİKLER

- Isıtmalı 4 litre tank sistemi.
- Kahve hazır olduğunda otomatik kapanma.
- Taşma önleyici sensör.
- Susuz kaldığında otomatik kapanma
- 3 fincana kadar ölçü ayarlama seçeneği.
- Kahve hazır olduğunda sesli uyarı sistemi.
- Su bittiğinde sesli uyarı sistemi.

TECHNICAL SPECIFICATIONS

- Heated 4 liter tank system.
- Automatic shutdown when coffee is ready.
- Anti-overflow sensor.
- Automatic shut-off feature when water level is low.
- Option to measure up to 3 cups.
- Audible alert system when coffee is ready.
- Audible warning system when water runs out.

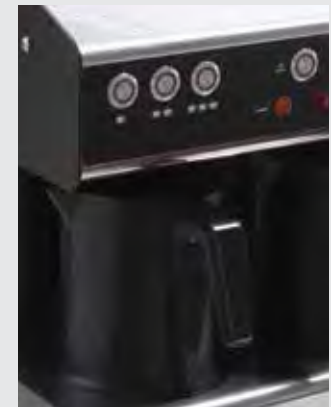

Cafe Bar Ekipmanları Cafe Bar Equipment

Demlikli Çay Otomatları Tea Maker with Pots

andora

CE



Kod Code	Ürün Adı Description	Ebatlar Dimension	Ağırlık Weight	Net Net	Güç Power	Kapasite Capacity
		a x b x c (mm)	(kg)	(m ³)	(kw)	(lt)
AND.DCY.120	Demlikli Çay Otomatı 120 Bardak Tea Maker With Pot 120 Cups	294x367x400	15	0.04	2	13
AND.DCY.250	Demlikli Çay Otomatı 250 Bardak Tea Maker With Pot 250 Cups	352x425x440	20	0.06	2.5	23
AND.DCY.350	Demlikli Çay Otomatı 350 Bardak Tea Maker With Pot 350 Cups	415x487x455	27	0.09	3.5	37

TEKNİK ÖZELLİKLER

- Termostat kontrol ünitesi.
- Isı yalıtımlı.
- İkaz lambası.
- Paslanmaz çelik iç hazne.

TECHNICAL SPECIFICATIONS

- Thermostat control unit.
- Heating isolation.
- Warning lamp.
- Stainless steel interior reservoir.





Kod Code	Ürün Adı Description	Ebatlar Dimension	Ağırlık Weight	Net Net	Güç Power	Kapasite Capacity
		a x b x c (mm)	(kg)	(m ³)	(kw)	(lt)
AND.CY.80	Çay Otomatı 80 Bardak Tea Maker 80 Cups	Ø 300x425	4	0.02	1.75	8
AND.CY.120	Çay Otomatı 120 Bardak Tea Maker 120 Cups	Ø 335x480	5	0.03	1.75	13
AND.CY.250	Çay Otomatı 250 Bardak Tea Maker 250 Cups	Ø 390x500	7	0.05	2.5	20
AND.CY.400	Çay Otomatı 400 Bardak Tea Maker 400 Cups	Ø 510x620	11	0.1	5	40

Kod Code	Ürün Adı Description	Ebatlar Dimension	Ağırlık Weight	Net Net	Güç Power	Kapasite Capacity
		a x b x c (mm)	(kg)	(m ³)	(kw)	(lt)
AND.SU.80	Sıcak Su Otomatı 80 Bardak Hot Water Dispenser 80 Cups	Ø 300x425	3	0.02	1.75	8
AND.SU.120	Sıcak Su Otomatı 120 Bardak Hot Water Dispenser 120 Cups	Ø 335x480	4	0.03	1.75	13
AND.SU.250	Sıcak Su Otomatı 250 Bardak Hot Water Dispenser 250 Cups	Ø 390x500	6	0.05	2.5	20
AND.SU.400	Sıcak Su Otomatı 400 Bardak Hot Water Dispenser 400 Cups	Ø 510x620	8	0.1	5	40

TEKNİK ÖZELLİKLER

- Termostat kontrol ünitesi.
- Paslanmaz çelik gövde.

TECHNICAL SPECIFICATIONS

- Thermostat control unit.
- Stainless steel body.

Cafe Bar Ekipmanları Cafe Bar Equipment

Gazlı Döner Ocakları (Üstten Motorlu) Gas Shawarma Machines (Motor on Top)

andora



3
Isıtıcı Radyan
Burner

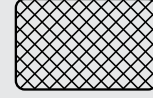

4
Isıtıcı Radyan
Burner

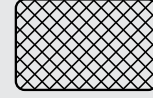

5
Isıtıcı Radyan
Burner



Kod Code	Ürün Adı Description	Ebatlar Dimension	Ağırlık Weight	Net Net	Güç Power	Isıtıcı Burner
		a x b x c (mm)	(kg)	(m ³)	(kw)	
AND.DN.220	Gazlı Döner Ocağı Üstten Motorlu Gas Shawarma Machines Motor on Top	630x830x983	30	0.51	10.5	3
AND.DN.221	Gazlı Döner Ocağı Üstten Motorlu Gas Shawarma Machines Motor on Top	630x830x1163	34	0.60	14	4
AND.DN.222	Gazlı Döner Ocağı Üstten Motorlu Gas Shawarma Machines Motor on Top	630x830x1343	39	0.70	17.5	5
AND.KT.01	Paslanmaz Çelik Kanat (3'lü Isıtıcı) Stainless Steel Wing (3 Burners)					
AND.KT.02	Paslanmaz Çelik Kanat (4'lü Isıtıcı) Stainless Steel Wing (4 Burners)					
AND.KT.03	Paslanmaz Çelik Kanat (5'lü Isıtıcı) Stainless Steel Wing (5 Burners)					

TEKNİK ÖZELLİKLER

- Lpg veya doğalgazla çalışabilme imkanı.
- 220V-50Hz enerji.
- Üstten Motorlu.
- Magnet emniyet ventilli musluklar.
- Ayarlanabilir döner şişi.
- Çift yöne dönebilme özelliği.
- Hijyenik ve emniyetli.
- Paslanmaz çelik gövde.

TECHNICAL SPECIFICATIONS

- Lpg or naturel gas.
- 220V-50Hz
- Motor on Top.
- Magnet safety valve.
- Adjustable spear.
- Dual direction option.
- Hygienic and safe.
- Stainless steel body.

AND.DN.220

- Gaz Tüketim Değeri (ng): 1,10 m³/h
- Gaz Tüketim Değeri (lpg): 0,80 kg/h

AND.DN.221

- Gaz Tüketim Değeri (ng): 1,48 m³/h
- Gaz Tüketim Değeri (lpg): 1,09 kg/h

AND.DN.222

- Gaz Tüketim Değeri (ng): 1,85 m³/h
- Gaz Tüketim Değeri (lpg): 1,36 kg/h

AND.DN.220

- Gas Consumption (ng): 1,10 m³/h
- Gas Consumption (lpg): 0,80 kg/h

AND.DN.221

- Gas Consumption (ng): 1,48 m³/h
- Gas Consumption (lpg): 1,09 kg/h

AND.DN.222

- Gas Consumption (ng): 1,85 m³/h
- Gas Consumption (lpg): 1,36 kg/h

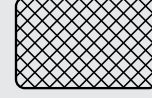
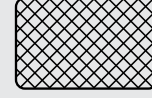

AND.KT.01 - AND.KT.02 - AND.KT.03
Paslanmaz Çelik Kanatlar Stainless
Steel Wings

3
 Isıtıcı Radyan
 Burner

4
 Isıtıcı Radyan
 Burner

5
 Isıtıcı Radyan
 Burner

Kod Code	Ürün Adı Description	Ebatlar Dimension	Ağırlık Weight	Net Net	Güç Power	Isıtıcı Burner
		a x b x c (mm)	(kg)	(m ³)	(kw)	
AND.DN.150	Gazlı Döner Ocağı Altın Motorlu Gas Shawarma Machines Motor at Bottom	568x707x964	36	0.39	10.5	3
AND.DN.151	Gazlı Döner Ocağı Altın Motorlu Gas Shawarma Machines Motor at Bottom	568x707x1158	41	0.46	14	4
AND.DN.152	Gazlı Döner Ocağı Altın Motorlu Gas Shawarma Machines Motor at Bottom	568x707x1337	44	0.54	17.5	5
AND.KT.01	Paslanmaz Çelik Kanat (3'lü Isıtıcı) Stainless Steel Wing (3 Burners)					
AND.KT.02	Paslanmaz Çelik Kanat (4'lü Isıtıcı) Stainless Steel Wing (4 Burners)					
AND.KT.03	Paslanmaz Çelik Kanat (5'lü Isıtıcı) Stainless Steel Wing (5 Burners)					
AND.PT.01	Paslanmaz Çelik Tepsi Genişletme Sacı Stainless Steel Tray Expand Plate					

TEKNİK ÖZELLİKLER

- Lpg veya doğalgazla çalışabilme imkanı.
- 220V-50Hz enerji.
- Magnet emniyet ventilli musluklar.
- Altın hareketli kızaklar döner etinin ısıtıcıya yaklaşmasını sağlar.
- Ayarlanabilir döner şişi.
- Çift yöne dönebilme özelliği.
- Hijyenik ve emniyetli.
- Paslanmaz çelik gövde.

AND.DN.150

- Gaz Tüketim Değeri (ng): 1,10 m³/h
- Gaz Tüketim Değeri (lpg): 0,80 kg/h

AND.DN.151

- Gaz Tüketim Değeri (ng): 1,48 m³/h
- Gaz Tüketim Değeri (lpg): 1,09 kg/h

AND.DN.152

- Gaz Tüketim Değeri (ng): 1,85 m³/h
- Gaz Tüketim Değeri (lpg): 1,36 kg/h

TECHNICAL SPECIFICATIONS

- Lpg or naturel gas.
- 220V-50Hz
- Magnet safety valve.
- Sliding bottom housing of the spear provides shawarma meat to get closer to burner.
- Adjustable spear.
- Dual direction option.
- Hygienic and safe.
- Stainless steel body.

AND.DN.150

- Gas Consumption (ng): 1,10 m³/h
- Gas Consumption (lpg): 0,80 kg/h

AND.DN.151

- Gas Consumption (ng): 1,48 m³/h
- Gas Consumption (lpg): 1,09 kg/h

AND.DN.152

- Gas Consumption (ng): 1,85 m³/h
- Gas Consumption (lpg): 1,36 kg/h

AND.KT.01 - AND.KT.02 - AND.KT.03
 Paslanmaz Çelik Kanatlar Stainless
 Steel Wings

AND.PT.01
 Paslanmaz Çelik Tepsi Genişletme Sacı
 Stainless Steel Tray Expansion Plate

Cafe Bar Ekipmanları Cafe Bar Equipment

Elektrikli Camlı Döner Ocakları (Alttan Motorlu) Electrical Robax Glass Shawarma Machines (Motor at Bottom)

andora

CE



- 3** Isıtıcı Radyan Burner
- 4** Isıtıcı Radyan Burner
- 5** Isıtıcı Radyan Burner



Kod Code	Ürün Adı Description	Ebatlar Dimension	Ağırlık Weight	Net Net	Güç Power	Isıtıcı Burner
		a x b x c (mm)	(kg)	(m ³)	(kw)	
AND.DN.170	Camlı Döner Ocağı Alttan Motorlu Robax Glass Shawarma Machine Motor at Bottom	568x706x964	36	0.39	4.2	3
AND.DN.171	Camlı Döner Ocağı Alttan Motorlu Robax Glass Shawarma Machine Motor at Bottom	568x706x1158	41	0.47	5.6	4
AND.DN.172	Camlı Döner Ocağı Alttan Motorlu Robax Glass Shawarma Machine Motor at Bottom	568x706x1337	53	0.54	7	5
AND.KT.01	Paslanmaz Çelik Kanat (3'lü Isıtıcı) Stainless Steel Wing (3 Burners)					
AND.KT.02	Paslanmaz Çelik Kanat (4'lü Isıtıcı) Stainless Steel Wing (4 Burners)					
AND.KT.03	Paslanmaz Çelik Kanat (5'lü Isıtıcı) Stainless Steel Wing (5 Burners)					
AND.PT.01	Paslanmaz Çelik Tepsi Genişletme Sacı Stainless Steel Tray Expand Plate					

TEKNİK ÖZELLİKLER

- Düşük ve yüksek 2 kademeli pişirme sıcaklığı.
- 380V-50Hz enerji.
- ROBAX Color S termal cam.
- Alttan hareketli kızaklar döner etinin ısıtıcıya yaklaşmasını sağlar.
- Ayarlanabilir döner şişi.
- Çift yöne dönebilme özelliği.
- Paslanmaz çelik gövde.

TECHNICAL SPECIFICATIONS

- Low and high two stage cooking temperature.
- 380V-50 Hz
- ROBAX Color S thermal glass.
- Sliding bottom housing of the spear provides shawarma meat to get closer to burner
- Adjustable spear
- Dual direction option.
- Stainless steel body.



AND.KT.01 - AND.KT.02 - AND.KT.03
Paslanmaz Çelik Kanatlar Stainless Steel Wings



AND.PT.01
Paslanmaz Çelik Tepsi Genişletme Sacı
Stainless Steel Tray Expansion Plate

Gazlı Camlı Döner Ocakları (Alttan Motorlu)

Gas Robax Glass Shawarma Machines (Motor at Bottom)



Cafe Bar Ekipmanları

Cafe Bar Equipment

- 3** Isıtıcı Radyan Burner
- 4** Isıtıcı Radyan Burner
- 5** Isıtıcı Radyan Burner



Kod Code	Ürün Adı Description	Ebatlar Dimension a x b x c (mm)	Ağırlık Weight (kg)	Net Net (m ³)	Güç Power (kw)	Isıtıcı Burner
AND.DN.210	Camlı Döner Ocağı Alttan Motorlu Robax Glass Shawarma Machine Motor at Bottom	568x706x964	36	0.39	10.5	3
AND.DN.211	Camlı Döner Ocağı Alttan Motorlu Robax Glass Shawarma Machine Motor at Bottom	568x706x1158	43	0.47	14	4
AND.DN.212	Camlı Döner Ocağı Alttan Motorlu Robax Glass Shawarma Machine Motor at Bottom	568x706x1337	47	0.54	17.5	5
AND.KT.01	Paslanmaz Çelik Kanat (3'lü Isıtıcı) Stainless Steel Wing (3 Burners)					
AND.KT.02	Paslanmaz Çelik Kanat (4'lü Isıtıcı) Stainless Steel Wing (4 Burners)					
AND.KT.03	Paslanmaz Çelik Kanat (5'lü Isıtıcı) Stainless Steel Wing (5 Burners)					
AND.PT.01	Paslanmaz Çelik Tepsi Genişletme Sacı Stainless Steel Tray Expand Plate					

TEKNİK ÖZELLİKLER

- Lpg veya doğalgazla çalışabilme imkanı.
- 220V-50Hz enerji.
- ROBAX Color S termal cam.
- Magnet emniyet ventilli musluklar.
- Alttan hareketli kızaklar döner etinin ısıtıcıya yaklaşmasını sağlar.
- Ayarlanabilir döner şişi.
- Çift yöne dönebilme özelliği.
- Paslanmaz çelik gövde.

TECHNICAL SPECIFICATIONS

- Lpg or naturel gas.
- 220V-50 Hz
- ROBAX Color S thermal glass.
- Magnet safety valves.
- Sliding bottom housing of the spear provides shawarma meat to get closer to burner
- Adjustable spear
- Dual direction option.
- Stainless steel body.

AND.DN.210

- Gaz Tüketim Değeri (ng): 1,10 m³/h
- Gaz Tüketim Değeri (lpg): 0,80 kg/h

AND.DN.211

- Gaz Tüketim Değeri (ng): 1,48 m³/h
- Gaz Tüketim Değeri (lpg): 1,09 kg/h

AND.DN.212

- Gaz Tüketim Değeri (ng): 1,85 m³/h
- Gaz Tüketim Değeri (lpg): 1,36 kg/h

AND.DN.210

- Gas Consumption (ng): 1,10 m³/h
- Gas Consumption (lpg): 0,80 kg/h

AND.DN.211

- Gas Consumption (ng): 1,48 m³/h
- Gas Consumption (lpg): 1,09 kg/h

AND.DN.212

- Gas Consumption (ng): 1,85 m³/h
- Gas Consumption (lpg): 1,36 kg/h



AND.KT.01 - AND.KT.02 - AND.KT.03
Paslanmaz Çelik Kanatlar Stainless
Steel Wings



AND.PT.01
Paslanmaz Çelik Tepsi Genişletme Sacı
Stainless Steel Tray Expansion Plate

Cafe Bar Ekipmanları Cafe Bar Equipment

Gazlı Döner Ocakları V Tip (Alttan Motorlu) Gas Shawarma Machines V Type (Motor at Bottom)

andora

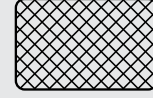

8
Isıtıcı Radyan
Burner

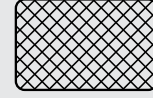

10
Isıtıcı Radyan
Burner



Kod Code	Ürün Adı Description	Ebatlar Dimension	Ağırlık Weight	Net Net	Güç Power	Isıtıcı Burner
		a x b x c (mm)	(kg)	(m ³)	(kw)	
AND.DN.151-Y	Gazlı Döner Ocağı Alttan Motorlu V Tip Gas Shawarma Machine Motor at Bottom V Type	715x860x1215	86	0.75	28	8
AND.DN.152-Y	Gazlı Döner Ocağı Alttan Motorlu V Tip Gas Shawarma Machine Motor at Bottom V Type	715x860x1395	90	0.86	35	10
AND.KT.01	Paslanmaz Çelik Kanat (3'lü Isıtıcı) Stainless Steel Wing (3 Burners)					
AND.KT.02	Paslanmaz Çelik Kanat (4'lü Isıtıcı) Stainless Steel Wing (4 Burners)					
AND.KT.03	Paslanmaz Çelik Kanat (5'lü Isıtıcı) Stainless Steel Wing (5 Burners)					
AND.PT.01-Y	Paslanmaz Çelik Tepsi Genişletme Sacı Stainless Steel Tray Expand Plate					

TEKNİK ÖZELLİKLER

- Lpg veya doğalgazla çalışabilme imkanı.
- 220V-50Hz enerji.
- Magnet emniyet ventilli musluklar.
- Alttan hareketli kızaklar döner etinin ısıtıcıya yaklaşmasını sağlar.
- Ayarlanabilir döner şişi.
- Çift yöne dönebilme özelliği.
- Hijyenik ve emniyetli.
- Paslanmaz çelik gövde.

TECHNICAL SPECIFICATIONS

- Lpg or naturel gas.
- 220V-50Hz
- Magnet safety valve.
- Sliding bottom housing of the spear provides shawarma meat to get closer to burner.
- Adjustable spear.
- Dual direction option.
- Hygienic and safe.
- Stainless steel body.

AND.DN.151-Y

- Gaz Tüketim Değeri (ng): 2,96 m³/h
- Gaz Tüketim Değeri (lpg): 2,18 kg/h

AND.DN.151-Y

- Gas Consumption (ng): 2,96 m³/h
- Gas Consumption (lpg): 2,18 kg/h

AND.DN.152-Y

- Gaz Tüketim Değeri (ng): 3,70 m³/h
- Gaz Tüketim Değeri (lpg): 2,72 kg/h

AND.DN.152-Y

- Gas Consumption (ng): 3,70 m³/h
- Gas Consumption (lpg): 2,72 kg/h



AND.KT.01 - AND.KT.02 - AND.KT.03
Paslanmaz Çelik Kanatlar Stainless
Steel Wings



AND.PT.01-Y
Paslanmaz Çelik Tepsi Genişletme Sacı
Stainless Steel Tray Expansion Plate



Kod Code	Ürün Adı Description	Ebatlar Dimension	Ağırlık Weight	Net Net	Güç Power
		a x b x c (mm)	(kg)	(m ³)	(kw)
AND.101	Tost Makinesi (Tekli) Toaster (Single)	400x360x210	30	0.03	1.75
AND.102	Tost Makinesi (Blok) Toaster (Block)	540x300x210	33	0.04	1.95
AND.103	Tost Makinesi (Çiftli) Toaster (Double)	540x300x210	35	0.04	2.95

TEKNİK ÖZELLİKLER

- 220V 50 Hz enerji.
- Izgara olarak kullanabilme özelliği.
- Hijyenik ve emniyetli.
- Paslanmaz çelik gövde.

TECHNICAL SPECIFICATIONS

- 220V 50 Hz energy.
- Capable for operation as a grill.
- Hygienic and safe.
- Stainless steel body.



Cafe Bar Ekipmanları Cafe Bar Equipment

Krep ve Waffle Makineleri Crepe and Waffel Makers

andora

CE



Kod Code	Ürün Adı Description	Ebatlar Dimension	Ağırlık Weight	Net Net	Güç Power	Kapasite Capacity
		a x b x c (mm)	(kg)	(m ³)	(kw)	(cm)
AND.KR.010	Tekli Krep Makinesi Single Crep Machine	450x520x240	19	0.06	2.2	40 Ø
AND.KR.020	Çiftli Krep Makinesi Double Crep Machine	900x520x240	37	0.12	2x2.2	2x(40 Ø)

TEKNİK ÖZELLİKLER

- 220V 50 Hz. enerji.
- Estetik ve fonksiyonel tasarım.
- Paslanmaz çelik gövde.

TECHNICAL SPECIFICATIONS

- 220V 50 Hz. energy.
- Functionel design.
- Stainles steel body.



Kod Code	Ürün Adı Description	Ebatlar Dimension	Ağırlık Weight	Net Net	Güç Power	Kapasite Capacity
		a x b x c (mm)	(kg)	(m ³)	(kw)	(cm)
AND.WF.010	Tekli Waffle Makinesi Single Waffle Maker	300x320x300	31	0.03	2.2	2x(10x17)
AND.WF.020	Çiftli Waffle Makinesi Double Waffle Maker	600x320x300	63	0.06	2 x 2.2	4x(10x17)

TEKNİK ÖZELLİKLER

- 220V 50 Hz. enerji.
- Estetik ve fonksiyonel tasarım.
- Paslanmaz çelik gövde.

TECHNICAL SPECIFICATIONS

- 220V 50 Hz. energy.
- Functionel design.
- Stainles steel body.



Kod Code	Ürün Adı Description	Ebatlar Dimension	Ağırlık Weight	Net Net	Güç Power
		a x b x c (mm)	(kg)	(m ³)	(kw)
AND.PSE010	Elektrikli Salamander Izgara Electrical Salamander Grill	450x502x517	39	0.12	3
AND.PSE020	Elektrikli Salamander Izgara Electrical Salamander Grill	650x502x517	49	0.17	3.4

TEKNİK ÖZELLİKLER

- Termostatik kumanda.
- Isıtma sistemi yukarı ve aşağıya yakınlştırılabilir.
- Kolay temizlenebilir ve hijyeniktir.
- Paslanmaz çelik gövde.

TECHNICAL SPECIFICATIONS

- Thermostatic controller.
- Slides can be adjusted on a different height.
- Easy to clean and hygienic.
- Stainless steel body.

- Elektrik Girişi: 230V AC 1N PE
- Kablo Kesiti (mm²): 3x2,5

- Electric Input: 230V AC 1N PE
- Cable Cross Section (mm²): 3x2,5

Cafe Bar Ekipmanları Cafe Bar Equipment

Gazlı Salamander Izgaralar Gas Salamander Grills

andora



Kod Code	Ürün Adı Description	Ebatlar Dimension a x b x c (mm)	Ağırlık Weight (kg)	Net Net (m ³)	Güç Power (kw)
AND.PSG.3	3 Brülörlü Gazlı Salamander Izgara 3 Burners Gas Salamander Grill	804x568x580	45	0.22	10.5
AND.PSG.4	4 Brülörlü Gazlı Salamander Izgara 4 Burners Gas Salamander Grill	964x568x580	55	0.26	14
AND.PSG.5	5 Brülörlü Gazlı Salamander Izgara 5 Burners Gas Salamander Grill	1124x568x580	62	0.31	17.5
AND.PSG.6	6 Brülörlü Gazlı Salamander Izgara 6 Burners Gas Salamander Grill	1284x568x580	77	0.35	21

TEKNİK ÖZELLİKLER

- Isıtma sistemi yukarı ve aşağı yakınlıştırılabilir.
- Ventilli gaz musluğu aracılığıyla ısı derecesi ayarı.
- Cihaza nemlendirme özelliği katan hareketli alt tepsi.
- Paslanmaz çelik gövde.

TECHNICAL SPECIFICATIONS

- Slides can be adjusted on a different height.
- Gas valve provides temperature control.
- Moisturizing option by the removable tray.
- Stainless steel body.

AND.PSG.3

- Gaz Tüketim Değeri (ng): 1,10 m³/h
- Gaz Tüketim Değeri (lpg): 0,58 kg/h

AND.PSG.4

- Gaz Tüketim Değeri (ng): 1,48 m³/h
- Gaz Tüketim Değeri (lpg): 0,77 kg/h

AND.PSG.5

- Gaz Tüketim Değeri (ng): 1,85 m³/h
- Gaz Tüketim Değeri (lpg): 0,97 kg/h

AND.PSG.6

- Gaz Tüketim Değeri (ng): 2,20 m³/h
- Gaz Tüketim Değeri (lpg): 1,16 kg/h

AND.PSG.3

- Gas Consumption (ng): 1,10 m³/h
- Gas Consumption (lpg): 0,58 kg/h

AND.PSG.4

- Gas Consumption (ng): 1,48 m³/h
- Gas Consumption (lpg): 0,77 kg/h

AND.PSG.5

- Gas Consumption (ng): 1,85 m³/h
- Gas Consumption (lpg): 0,97 kg/h

AND.PSG.6

- Gas Consumption (ng): 2,20 m³/h
- Gas Consumption (lpg): 1,16 kg/h



AND.GP.40



Kod Code	Ürün Adı Description	Ebatlar Dimension	Ağırlık Weight	Net Net	Güç Power	Kapasite Capacity
		a x b x c (mm)	(kg)	(m³)	(kw)	(gn)
AND.STU.01	Sıcak Teşhir Ünitesi Hot Display Unit	725x570x562	19	0.23	1.3	2x1/1
AND.STU.02	Sıcak Teşhir Ünitesi Hot Display Unit	1040x570x562	27	0.33	1.9	3x1/1
AND.GP.40	Güveç ve Pizza Isıtma Ünitesi Casserole and Pizza Heater	Q 400	15		0.65	



Kod Code	Ürün Adı Description	Ebatlar Dimension	Ağırlık Weight	Net Net	Güç Power	Kapasite Capacity
		a x b x c (mm)	(kg)	(m³)	(kw)	(gn)
AND.AD.8060	Sıcak Teşhir Ünitesi Ahşap Gövdeli Hot Display Unit Wooden Body	800x600x120/750	22	0.36	1.3	2x1/1
AND.AD.11060	Sıcak Teşhir Ünitesi Ahşap Gövdeli Hot Display Unit Wooden Body	1115x600x120/750	35	0.50	1.8	3x1/1
AND.PD.8060	Sıcak Teşhir Ünitesi Paslanmaz Gövdeli Hot Display Unit Stainless Steel Body	800x600x120/750	27	0.36	1.3	2x1/1
AND.PD.11060	Sıcak Teşhir Ünitesi Paslanmaz Gövdeli Hot Display Unit Stainless Steel Body	1115x600x120/750	35	0.50	1.8	3x1/1

TEKNİK ÖZELLİKLER

- 220V çalışma voltajı.
- Demonte cam raf.
- Ayarlanabilir ayak.
- Dijital kontrol.
- Çalışma aralığı: 30 °C / 90 °C

TECHNICAL SPECIFICATIONS

- 220V operating voltage.
- Disassembled sneezeguard.
- Adjustable feet.
- Digital control.
- Working temperature: 30 °C / 90 °C

Cafe Bar Ekipmanları Cafe Bar Equipment

Ekmek Kızartma Makineleri ve Kuruyemiş Çekmeceleri Conveyor Toasters and Nuts Units

andora



Kod Code	Ürün Adı Description	Ebatlar Dimension	Ağırlık Weight	Net Net
		a x b x c (mm)	(kg)	(m ³)
AND.KU.01	4 Çekmeceli Isıtmalı Kuruyemiş Ünitesi 4 Drawers Heated Nuts Unit	340x380x450	11	0.06
AND.KU.02	6 Çekmeceli Isıtmalı Kuruyemiş Ünitesi 6 Drawers Heated Nuts Unit	500x380x450	15	0.9



Kod Code	Ürün Adı Description	Ebatlar Dimension	Ağırlık Weight	Net Net	Güç Power
		a x b x c (mm)	(kg)	(m ³)	(kw)
AND.MEK010	Konveyörlü Ekmek Kızartma Makinesi Conveyor Toaster	478x644x431	35	0.13	3.5

TEKNİK ÖZELLİKLER

- 600 dilim / saat kapasitesi.
- Termostatik kontrol.
- Paslanmaz çelik taşıyıcı tel.
- Kolay temizlenebilen ve hijyeniktir.
- Paslanmaz çelik gövde.

TECHNICAL SPECIFICATIONS

- Capacity: 600 bread slice / hour.
- Thermostatic controller.
- Stainless steel conveyor wire.
- Easy to clean and hygienic.
- Stainless steel body.

AND.MEK010

- Elektrik Girişi: 230V AC N PE
- Kablo Kesiti (mm²): 3x2,5

AND.MEK010

- Electric Input: 230V AC N PE
- Cable Cross Section (mm²): 3x2,5

Bulaşık Yıkama Makineleri

Dishwashers



andora



BULAŞIK YIKAMA MAKİNELERİ

- Bardak Yıkama Makineleri
- Set Altı Bulaşık Makineleri
- Set Altı Bulaşık Makineleri (Dijital Kontrol)
- Set Altı Bulaşık Makineleri (Çift Cidarlı)
- Giyotin Tipi Bulaşık Makineleri
- Giyotin Tipi Bulaşık Makineleri (Çift Cidarlı)
- Konveyörlü Bulaşık Makineleri (Kurutma Tüneli)
- Kazan Yıkama Makineleri
- Bulaşık Makinesi Basketleri - Ön Yıkama Duş Üniteleri
- Bulaşık Makinesi Giriş-Çıkış Tezgahları
- Konveyörlü Bulaşık Makinesi Giriş-Çıkış Tezgahları

DISHWASHERS

- Glasswashers
- Undercounter Type Dishwashers
- Undercounter Type Dishwashers (Digital Control)
- Undercounter Type Dishwashers (Double Skin)
- Hood Type Dishwashers
- Hood Type Dishwashers (Double Skin)
- Conveyor Type Dishwashers (Drying Tunnel)
- Pot Washing Machines
- Dishwasher Baskets - Pre-washing Units
- Dishwasher Inlet-Outlet
- Conveyor Type Dishwasher Inlet-Outlet



AND.1100



AND.1100-S

COLD RINSING

DIGITAL CONTROL

Kod Code	Ürün Adı Description	Ebatlar Dimension	Ağırlık Weight	Net Net	Kapasite Capacity
		a x b x c (mm)	(kg)	(m ³)	(bardak/saat-glass/hour)
AND.1100	Bardak Yıkama Makinesi 220V Glasswasher 220V	480x580x720	43	0.20	1000
AND.1100-S	Bardak Yıkama Makinesi 220V Glasswasher 220V	480x580x720	43	0.20	1000

TEKNİK ÖZELLİKLER

- 90/120/180 saniye olmak üzere 3 farklı program.
- Parlatici pompası standart.
- Drenaj pompası standart.
- Ekonomik su, deterjan ve enerji tüketimi.
- Basket ölçüleri 400x400 mm
- Motor gücü: 0.25 kW 2800 D/Dk
- Yıkama tankı ısıtıcı gücü: 2.5 kW
- Durulama boyler ısıtıcı gücü: 2 kW
- Çalışma esnasında maksimum güç: 2.75 kW

TECHNICAL SPECIFICATIONS

- 3 different programs, 90/120/180 seconds.
- Standart polisher pump.
- Standart drain pump.
- Economical water, detergent and energy consumption.
- Basket dimensions 400x400 mm
- Motor power: 0.25 kW 2800 rpm
- Washing tank heating power: 2.5 kW
- Rinse boiler heater power: 2 kW
- Maximum power during operation: 2.75 kW

**AND.1100-S**

- Soğuk su ile durulama sistemi.
- Dijital Kontrol Panelli.

AND.1100-S

- Rinsing system with cold water.
- With Dijital Control Panel.

Bulaşık Yıkama Makineleri Dishwashers

Set Altı Bulaşık Makineleri Undercounter Type Dishwashers

andora



Kod Code	Ürün Adı Description	Ebatlar Dimension	Ağırlık Weight	Net Net	Kapasite Capacity
		a x b x c (mm)	(kg)	(m ³)	(tabak/saat plate/hour)
AND.500	Set Altı Bulaşık Makinesi 220V Undercounter Type Dishwasher 220V	590x660x830	64	0.33	500
AND.500-380	Set Altı Bulaşık Makinesi 380V Undercounter Type Dishwasher 380V	590x660x830	64	0.33	500
AND.500-F	Full Set Altı Bulaşık Makinesi 220V Full Undercounter Type Dishwasher 220V	590x660x830	64	0.33	500
AND.500-380-F	Full Set Altı Bulaşık Makinesi 380V Full Undercounter Type Dishwasher 380V	590x660x830	64	0.33	500

Su Basınç Pompası Fiyat Farkı
Price Difference for Water Pressure Pump

Su basınç pompası şebeke basıncının 2.5 bar'ın altında olduğu yerlerde kullanılır.
Water pressure pump is required for below 2.5 bar water connections.

TEKNİK ÖZELLİKLER

- 90/120/180 saniye olmak üzere 3 farklı program.
- Drenaj pompası standart.
- Ekonomik su, deterjan ve enerji tüketimi.
- Basket ölçüleri 500x500 mm
- Maksimum tabak çapı: 320 mm
- Paslanmaz çelik rezistanslar.
- Manyetik kapak güvenlik sensörü.
- Paslanmaz çelik gövde.
- Yıkama suyu sıcaklığı 55-60°C
- Durulama suyu sıcaklığı 80-85°C
- Motor gücü: 0.55 kW 2800 D/Dk
- Yıkama tankı ısıtıcı gücü: 2.5 kW
- Durulama boyler ısıtıcı gücü: 5 kW

AND.500-F - AND.500-380-F -
Deterjan ve Parlatıcı Pompalı.

TECHNICAL SPECIFICATIONS

- 3 different programs, 90/120/180 seconds.
- Standart drainage pump.
- Economical water, detergent and energy consumption.
- Basket dimensions 500x500 mm
- Maximum plate diameter: 320 mm
- Stainless steel resistances.
- Magnetic cover security sensor.
- Stainless steel body.
- Washing water temperature 55-60°C
- Rinse water temperature 80-85°C
- Motor power: 0.55 kW 2800 rpm
- Washing tank heating power: 2.5 kW
- Rinse boiler heater power: 5 kW

AND.500-F - AND.500-380-F
- With Detergent and RinseAid Pump.

AND.500 - AND.500-F

- Çalışma esnasında maksimum güç: 5.55 kW

AND.500-380 - AND.500-380-F

- Çalışma esnasında maksimum güç: 5.55 kW

AND.500 - AND.500-F

- Maximum power during operation: 5.55 kW

AND.500-380 - AND.500-380-F

- Maximum power during operation: 5.55 kW



DIGITAL CONTROL



Kod Code	Ürün Adı Description	Ebatlar Dimension	Ağırlık Weight	Net Net	Kapasite Capacity
		a x b x c (mm)	(kg)	(m ³)	(tabak/saat plate/hour)
AND.500-SD	Set Altı Bulaşık Makinesi Dijital Kontrollü 220V Undercounter Type Dishwasher Digital Control 220V	590x660x830	64	0.33	500
AND.500-380-SD	Set Altı Bulaşık Makinesi Dijital Kontrollü 380V Undercounter Type Dishwasher Digital Control 380V	590x660x830	64	0.33	500
AND.500-SDF	Full Set Altı Bulaşık Makinesi Dijital Kontrollü 220V Full Undercounter Type Dishwasher Digital Control 220V	590x660x830	64	0.33	500
AND.500-380-SDF	Full Set Altı Bulaşık Makinesi Dijital Kontrollü 380V Full Undercounter Type Dishwasher Digital Control 380V	590x660x830	64	0.33	500

Su Basınç Pompası Fiyat Farkı
Price Difference for Water Pressure PumpSu basınç pompası şebeke basıncının 2.5 bar'ın altında olduğu yerlerde kullanılır.
Water pressure pump is required for below 2.5 bar water connections.**TEKNİK ÖZELLİKLER**

- 60/90/120/180 saniye olmak üzere 4 farklı program.
- Drenaj pompası standart.
- Ekonomik su, deterjan ve enerji tüketimi.
- Basket ölçüleri 500x500 mm
- Maksimum tabak çapı: 320 mm
- Paslanmaz çelik rezistanslar.
- Manyetik kapak güvenlik sensörü.
- Paslanmaz çelik gövde.
- Yıkama suyu sıcaklığı 55-60°C
- Durulama suyu sıcaklığı 80-85°C
- Motor gücü: 0.55 kW 2800 D/Dk
- Yıkama tankı ısıtıcı gücü: 2.5 kW
- Durulama boyler ısıtıcı gücü: 5 kW

**AND.500-SDF - AND.500-380-SDF -
Deterjan ve Parlatıcı Pompalı.****TECHNICAL SPECIFICATIONS**

- 4 different programs, 60/90/120/180 seconds.
- Standart drain pump.
- Economical water, detergent and energy consumption.
- Basket dimensions 500x500 mm
- Maximum plate diameter: 320 mm
- Stainless steel resistances.
- Magnetic cover security sensor.
- Stainless steel body.
- Washing water temperature 55-60°C
- Rinse water temperature 80-85°C
- Motor power: 0.55 kW 2800 rpm
- Washing tank heating power: 2.5 kW
- Rinse boiler heater power: 5 kW

**AND.500-SDF - AND.500-380-SDF -
With Detergent and RinseAid Pump.****Dijital Kontrol Panosu**

- 2.4 inç renkli ekran.
- Aydınlatmalı dokunmatik kontrol panosu.
- Yıkama ve durulama kontrolü.
- Su tahliye kontrolü.
- Boyler ve tank sıcaklığını ayrı ayrı kontrol etme özelliği.
- Su geçirmez ön panel.

Digital Control Board

- 2.4 inch color screen.
- Enlightened touch control panel.
- Washing and rinsing motor control.
- Water drain control.
- Ability to control the boiler and tank temperature separately.
- Waterproof front panel.

AND.500-SD - AND.500-SDF

- Çalışma esnasında maksimum güç: 5.55 kW

AND.500-380-SD - AND.500-380-SDF

- Çalışma esnasında maksimum güç: 5.55 kW

AND.500-SD - AND.500-SDF

- Maximum power during operation: 5.55 kW

AND.500-380-SD - AND.500-380-SDF

- Maximum power during operation: 5.55 kW

Bulaşık Yıkama Makineleri Dishwashers

Set Altı Bulaşık Makineleri (Çift Cidarlı) Undercounter Type Dishwashers (Double Skin)

andora

CE



Çift Cidarlı Gövde / Double Skin Body.
Dijital Kontrol Panelli / With Dijital Control Panel
Deterjan ve Parlatici Pompalı / With Detergent and RinseAid Pump

Kod Code	Ürün Adı Description	Ebatlar Dimension	Ağırlık Weight	Net Net	Kapasite Capacity
		a x b x c (mm)	(kg)	(m ³)	(tabak/saat plate/hour)
AND.500-D	Set Altı Bulaşık Makinesi Çift Cidarlı 220V Undercounter Type Dishwasher Double Skin 220V	610x720x820	72	0.33	500
AND.500-D-380	Set Altı Bulaşık Makinesi Çift Cidarlı 380V Undercounter Type Dishwasher Double Skin 380V	610x720x820	72	0.33	500

TEKNİK ÖZELLİKLER

- 60/90/120/180 saniye olmak üzere 4 farklı program.
- Drenaj pompası standart.
- Ekonomik su, deterjan ve enerji tüketimi.
- Basket ölçüleri 500x500 mm
- Maksimum tabak çapı: 320 mm
- Paslanmaz çelik rezistanslar.
- Manyetik kapak güvenlik sensörü.
- Paslanmaz çelik gövde.
- Yıkama suyu sıcaklığı 55-60°C
- Durulama suyu sıcaklığı 80-85°C
- Motor gücü: 0.55 kW 2800 D/Dk.
- Yıkama tankı ısıtıcı gücü: 2.5 kW
- Durulama boyler ısıtıcı gücü: 5 kW

TECHNICAL SPECIFICATIONS

- 4 different programs, 60/90/120/180 seconds..
- Standart drainage pump.
- Economical water, detergent and energy consumption.
- Basket dimensions 500x500 mm
- Maximum plate diameter: 320 mm
- Stainless steel resistances.
- Magnetic cover security sensor.
- Stainless steel body.
- Washing water temperature 55-60°C
- Rinse water temperature 80-85°C
- Motor power: 0.55 kW 2800 rpm.
- Washing tank heating power: 2.5 kW
- Rinse boiler heater power: 5 kW

Dijital Kontrol Panosu

- 2.4 inç renkli ekran.
- Aydınlatmalı dokunmatik kontrol panosu.
- Yıkama ve durulama kontrolü.
- Su tahliye kontrolü.
- Boyler ve tank sıcaklığını ayrı ayrı kontrol etme özelliği.
- Su geçirmez ön panel.

Dijital Kontrol Board

- 2.4 inch color screen.
- Enlightened touch control panel.
- Washing and rinsing motor control.
- Water drain control.
- Ability to control the boiler and tank temperature separately.
- Waterproof front panel.

AND.500-D

- Çalışma esnasında maksimum güç: 5.55 kW

AND.500-D-380

- Çalışma esnasında maksimum güç: 5.55 kW

AND.500-D

- Maximum power during operation: 5.55 kW

AND.500-D-380

- Maximum power during operation: 5.55 kW



Kod Code	Ürün Adı Description	Ebatlar Dimension	Ağırlık Weight	Net Net	Kapasite Capacity
		a x b x c (mm)	(kg)	(m ³)	(tabak/saat plate/hour)
AND.1000	Giyotin Tipi Bulaşık Makinesi 380V Hood Type Dishwasher 380V	696x765x1485	112	0.79	1000
AND.1000-F	Full Giyotin Tipi Bulaşık Makinesi 380V Full Hood Type Dishwasher 380V	696x765x1485	112	0.79	1000
AND.1000-SD	Giyotin Tipi Bulaşık Makinesi Dijital Kontrol 380V Hood Type Dishwasher Digital Control 380V	696x765x1485	112	0.79	1000
AND.1000-SDF	Full Giyotin Tipi Bulaşık Makinesi Dijital Kontrol 380V Full Hood Type Dishwasher Digital Control 380V	696x765x1485	112	0.79	1000

Su Basınç Pompası Fiyat Farkı
Price Difference for Water Pressure Pump

Su basınç pompası şebeke basıncının 2.5 bar'ın altında olduğu yerlerde kullanılır.
Water pressure pump is required for below 2.5 bar water connections.

TEKNİK ÖZELLİKLER

- 60/90/120/180 saniye olmak üzere 4 farklı program.
- Ekonomik su, deterjan ve enerji tüketimi.
- Basket ölçüleri 500x500 mm
- Paslanmaz çelik rezistanslar.
- Paslanmaz çelik gövde.
- Yıkama suyu sıcaklığı 55-60°C
- Durulama suyu sıcaklığı 80-85°C
- Motor gücü: 0.55 kW 2800 D/Dk
- Yıkama tankı ısıtıcı gücü: 2.5 kW
- Durulama boyler ısıtıcı gücü: 6 kW
- Çalışma esnasında maksimum güç: 6.55 kW

AND.1000-F

- Deterjan ve Parlatıcı Pompalı.

AND.1000-SD

- Dijital Kontrol Panelli.

AND.1000-SDF

- Dijital Kontrol Panelli.
- Deterjan ve Parlatıcı Pompalı.

TECHNICAL SPECIFICATIONS

- 4 different programs, 60/90/120/180 seconds.
- Economical water, detergent and energy consumption.
- Basket dimensions 500x500 mm
- Stainless steel resistances.
- Stainless steel body.
- Washing water temperature 55-60°C
- Rinse water temperature 80-85°C
- Motor power: 0.55 kW 2800 rpm.
- Washing tank heating power: 2.5 kW
- Rinse boiler heater power: 6 kW
- Maximum power during operation: 6.55 kW

AND.1000-F

- With Detergent and Rinse Aid Pump.

AND.1000-SD

- With Dijital Control Panel.

AND.1000-SDF

- With Dijital Control Panel.
- With Detergent and Rinse Aid Pump.

AND.1000-SD - AND.1000-SDF Dijital Kontrol Panosu

- 2.4 inç renkli ekran.
- Aydınlatmalı dokunmatik kontrol panosu.
- Yıkama ve durulama kontrolü.
- Su tahliye kontrolü.
- Boyler ve tank sıcaklığını ayrı ayrı kontrol etme özelliği.
- Su geçirmez ön panel.

AND.1000-SD - AND.1000-SDF Digital Control Board

- 2.4 inch color screen.
- Enlightened touch control panel.
- Washing and rinsing motor control.
- Water drain control.
- Ability to control the boiler and tank temperature separately.
- Waterproof front panel.

Bulaşık Yıkama Makineleri Dishwashers

Giyotin Tipi Bulaşık Makineleri (Çift Cidarlı) Hood Type Dishwashers (Double Skin)

andora

CE



Çift Cidarlı Gövde / Double Skin Body.
Dijital Kontrol Panelli / With Dijital Control Panel
Deterjan ve Parlatıcı Pompalı / With Detergent and RinseAid Pump

Kod Code	Ürün Adı Description	Ebatlar Dimension	Ağırlık Weight	Net Net	Kapasite Capacity
		a x b x c (mm)	(kg)	(m ³)	(tabak/saat plate/hour)
AND.1000-D	Giyotin Tipi Bulaşık Makinesi Çift Cidarlı Hood Type Dishwasher Double Skin	720x840x1570	150	0.95	1000

TEKNİK ÖZELLİKLER

- 60/90/120/180 saniye olmak üzere 4 farklı program.
- Drenaj pompası standart.
- Deterjan ve Parlatıcı Pompalı.
- Ekonomik su, deterjan ve enerji tüketimi.
- Basket ölçüleri 500x500 mm
- Paslanmaz çelik rezistanslar.
- Paslanmaz çelik gövde.
- Yıkama suyu sıcaklığı 55-60°C
- Durulama suyu sıcaklığı 80-85°C
- Motor gücü: 0.55 kW 2800 D/Dk
- Yıkama tankı ısıtıcı gücü: 2.5 kW
- Durulama boyler ısıtıcı gücü: 6 kW
- Çalışma esnasında maksimum güç: 6.55 kW

TECHNICAL SPECIFICATIONS

- 4 different programs, 60/90/120/180 seconds.
- Standart drainage pump.
- With Detergent and Rinse Aid Pump.
- Economical water, detergent and energy consumption.
- Basket dimensions 500x500 mm
- Stainless steel resistances
- Stainless steel body.
- Washing water temperature 55-60°C
- Rinse water temperature 80-85°C
- Motor power: 0.55 kW 2800 rpm.
- Washing tank heating power: 2.5 kW
- Rinse boiler heater power: 6 kW
- Maximum power during operation: 6.55 kW

Dijital Kontrol Panosu

- 2.4 inç renkli ekran.
- Aydınlatmalı dokunmatik kontrol panosu.
- Yıkama ve durulama kontrolü.
- Su tahliye kontrolü.
- Boyler ve tank sıcaklığını ayrı ayrı kontrol etme özelliği.
- Su geçirmez ön panel.

Dijital Kontrol Board

- 2.4 inch color screen.
- Enlightened touch control panel.
- Washing and rinsing motor control.
- Water drain control.
- Ability to control the boiler and tank temperature separately.
- Waterproof front panel.

AND.3000-SAG-R
AND.3000-SOL-L

AND.2000-SAG-R
AND.2000-SOL-L

Ön Yıkamalı
 with Pre-Washing Unit

Kod Code	Ürün Adı Description	Ebatlar Dimension	Ağırlık Weight	Net Net	Kapasite Capacity
		a x b x c (mm)	(kg)	(m ³)	(tabak/saat plate/hour)
AND.2000-SAG-R	Konveyörlü Bulaşık Makinesi Kurutma Tüneli Conveyor Type Dishwasher with Drying Tunnel	1900x837x2000	317	3.18	2200
AND.2000-SOL-L	Konveyörlü Bulaşık Makinesi Kurutma Tüneli Conveyor Type Dishwasher with Drying Tunnel	1900x837x2000	317	3.18	2200
AND.3000-SAG-R	Konveyörlü Bulaşık Makinesi Kurutma Tüneli Conveyor Type Dishwasher with Drying Tunnel	2561x837x2000	405	4.29	2200/3300
AND.3000-SOL-L	Konveyörlü Bulaşık Makinesi Kurutma Tüneli Conveyor Type Dishwasher with Drying Tunnel	2561x837x2000	405	4.29	2200/3300

TEKNİK ÖZELLİKLER

- Standart kurutma tüneli.
- 2 hızlı konveyör bandı.
- 2 adet yıkama motoru.
- **Drenaj pompası standart.**
- Ekonomik su, deterjan ve enerji tüketimi.
- Basket ölçüleri 500x500 mm
- Paslanmaz çelik rezistanslar.
- Manyetik kapak güvenlik sensörü.
- Paslanmaz çelik gövde.
- Yıkama suyu sıcaklığı 55-60°C
- Durulama suyu sıcaklığı 80-85°C
- Kurutma ünitesi toplam gücü: 9 kW
- Yıkama tankı ısıtıcı gücü: 12 kW
- Durulama boyler ısıtıcı gücü: 24 kW
- Makine toplam gücü: 48 kW/380 V

AND.2000-SAG-R / AND.2000-SOL-L -
 Motor gücü: 0.55 kW 2800 D/Dk x 2

AND.3000-SAG-R / AND.3000-SOL-L -
 Motor gücü: 0.55 kW 2800 D/Dk x 3

TECHNICAL SPECIFICATIONS

- Standart drying tunnel.
- 2 speed conveyor band.
- 2 pieces of washing motors.
- **Standart drainage pump.**
- Economical water, detergent and energy consumption.
- Basket dimensions 500x500 mm
- Stainless steel resistances.
- Magnetic cover security sensor.
- Stainless steel body.
- Washing water temperature 55-60°C
- Rinse water temperature 80-85°C
- Drying unit total power: 9 kW
- Washing tank heating power: 12 kW
- Rinse boiler heater power: 24 kW
- Machine total power: 48 kW/380 V

AND.2000-SAG-R / AND.2000-SOL-L -
 Motor power: 0.55 kW 2800 rpm x 2

AND.3000-SAG-R / AND.3000-SOL-L -
 Motor power: 0.55 kW 2800 rpm x 3

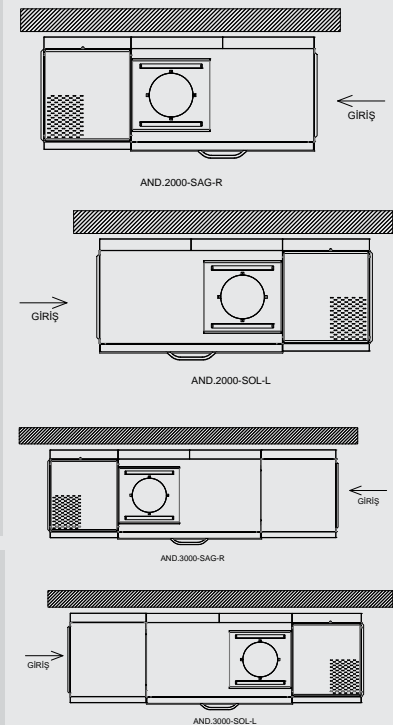

Bulaşık Yıkama Makineleri Dishwashers

Kazan Yıkama Makineleri Pot Washing Machines

andora



Kod Code	Ürün Adı Description	Ebatlar Dimension	Ağırlık Weight	Net Net
		a x b x c (mm)	(kg)	(m ³)
AND.UW-80	Kazan Yıkama Makinesi 80 Lt Pot Washing Machine 80 Lt	764x960x1985	210	1.46
AND.UW-130	Kazan Yıkama Makinesi 130 Lt Pot Washing Machine 130 Lt	1360x930x1985	300	2.51

TEKNİK ÖZELLİKLER

- 120/240/360 saniye olmak üzere 3 farklı program.
- Ekonomik su, deterjan ve enerji tüketimi.
- Manyetik kapı güvenlik sensörü.
- Paslanmaz çelik rezistanslar.
- Paslanmaz çelik gövde.
- Yıkama suyu sıcaklığı 55-60°C
- Durulama suyu sıcaklığı 80-85°C

TECHNICAL SPECIFICATIONS

- 3 different programs, 120/240/360 seconds.
- Economical water, detergent and energy consumption.
- Magnetic cover security sensor.
- Stainless steel resistances.
- Stainless steel body.
- Washing water temperature 55-60°C
- Rinse water temperature 80-85°C

AND.UW-80

- Tank kapasitesi: 80 lt
- Su tüketimi: 4,5 lt
- Kapasite: 30 basket/saat
- Kapasite: 240 adet 60x80 cm tepsi/saat
- Kapasite: 60x1/1 Gn-saat
- Motor gücü: 1.5 kW 2800 D/Dk
- Yıkama tankı ısıtıcı gücü: 6 kW
- Durulama boyler ısıtıcı gücü: 18 kW
- Makine toplam gücü: 30 kW/380 V

AND.UW-80

- Tank capacity: 80 lt
- Water consumption: 4,5 lt
- Capacity: 30 basket/hour
- Capacity: 240 pieces 60x80 cm tray/hour
- Capacity: 60x1/1 Gn-hour
- Motor power: 1.5 kW 2800 rpm
- Tank heating power: 6 kW
- Rinse boiler heating power 18 kW
- Machine total power: 30 kW/380 V

AND.UW-130

- Tank kapasitesi: 130 lt
- Su tüketimi: 7,5 lt
- Kapasite: 30 basket/saat
- Kapasite: 480 adet 60x80 cm tepsi/saat
- Kapasite: 120x1/1 Gn-saat
- Motor gücü: 1.5 kW 2800 D/Dk x 2
- Yıkama tankı ısıtıcı gücü: 12 kW
- Durulama boyler ısıtıcı gücü: 18 kW
- Makine toplam gücü: 40 kW/380 V

AND.UW-130

- Tank capacity: 130 lt
- Water consumption: 7,5 lt
- Capacity: 30 basket/hour
- Capacity: 480 pieces 60x80 cm tray/hour
- Capacity: 120x1/1 Gn-hour
- Motor power: 1.5 kW 2800 rpm x 2
- Tank heating power: 12 kW
- Rinse boiler heating power 18 kW
- Machine total power: 40 kW/380V



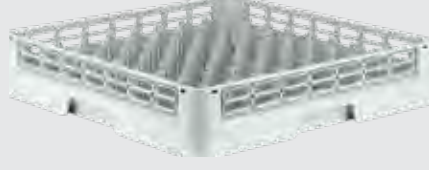

Kod Code	Ürün Adı Description	Ebatlar Dimension a x b x c (mm)	Ağırlık Weight (kg)	Net Net (m ³)
AND.TB.01	Tabak Basketi Dish Basket	500x500x110	1.60	0.02
AND.KC.01	Kaşık Çatal Basketi Cutlery Basket	500x500x110	1.55	0.02
AND.BB.01	Bardak Basketi Glass Basket	500x500x110	1.55	0.02
AND.1100.007	Bardak Basketi Glass Basket	400x400x120	1.30	0.02



Kod Code	Ürün Adı Description
AND.OYD.01	Tezgaha Monte Ön Yıkama Duşu Counter Mounted Pre-washing Unit
AND.OYD.02	Duvara Monte Ön Yıkama Duşu Wall Mounted Pre-washing Unit
AND.OYD.03	Armatürlü Tezgaha Monte Ön Yıkama Duşu Counter Mounted Pre-wash Spray Unit with Double Batteries

TEKNİK ÖZELLİKLER

- Lekesiz yıkama özelliği.
- Kontrollü basınç sistemi.
- Dayanıklı yapı.

TECHNICAL SPECIFICATIONS

- Spotless washing.
- Controlled pressure system.
- Durable structure.

Bulaşık Yıkama Makineleri Dishwashers

Bulaşık Makinesi Giriş-Çıkış Tezgahları Dishwasher Inlet-Outlet

andora



Kod Code	Ürün Adı Description	Ebatlar Dimension	Net Net
		a x b x c (mm)	(m ³)
AND.BYG.7560-1ET-R	Bulaşık Makinesi Giriş Tezgahı Tek Evgeli Taban Rafı (Sağ) Dishwasher Inlet Bench Single Sink With Base Shelf (Right)	600x750x890	0.4
AND.BYG.7560-1ET-L	Bulaşık Makinesi Giriş Tezgahı Tek Evgeli Taban Rafı (Sol) Dishwasher Inlet Bench Single Sink With Base Shelf (Left)	600x750x890	0.4
AND.BYG.7590-1ET-R	Bulaşık Makinesi Giriş Tezgahı Tek Evgeli Taban Rafı (Sağ) Dishwasher Inlet Bench Single Sink With Base Shelf (Right)	900x750x890	0.6
AND.BYG.7590-1ET-L	Bulaşık Makinesi Giriş Tezgahı Tek Evgeli Taban Rafı (Sol) Dishwasher Inlet Bench Single Sink With Base Shelf (Left)	900x750x890	0.6
AND.BYG.75120-1ET-R	Bulaşık Makinesi Giriş Tezgahı Tek Evgeli Taban Rafı (Sağ) Dishwasher Inlet Bench Single Sink With Base Shelf (Right)	1200x750x890	0.8
AND.BYG.75120-1ET-L	Bulaşık Makinesi Giriş Tezgahı Tek Evgeli Taban Rafı (Sol) Dishwasher Inlet Bench Single Sink With Base Shelf (Left)	1200x750x890	0.8
AND.BYG.75150-1EC-R	Bulaşık Makinesi Giriş Tezgahı Tek Evgeli Taban Rafı (Sağ) Dishwasher Inlet Bench Single Sink With Base Shelf (Right)	1500x750x890	1
AND.BYG.75150-1EC-L	Bulaşık Makinesi Giriş Tezgahı Tek Evgeli Taban Rafı (Sol) Dishwasher Inlet Bench Single Sink With Base Shelf (Left)	1500x750x890	1
AND.BYC.7560-T-R	Bulaşık Makinesi Çıkış Tezgahı Taban Rafı (Sağ) Dishwasher Outlet Counter With Base Shelf (Right)	600x750x890	0.4
AND.BYC.7560-T-L	Bulaşık Makinesi Çıkış Tezgahı Taban Rafı (Sol) Dishwasher Outlet Counter With Base Shelf (Sol)	600x750x890	0.4
AND.BYC.7590-T-R	Bulaşık Makinesi Çıkış Tezgahı Taban Rafı (Sağ) Dishwasher Outlet Counter With Base Shelf (Right)	900x750x890	0.6
AND.BYC.7590-T-L	Bulaşık Makinesi Çıkış Tezgahı Taban Rafı (Sol) Dishwasher Outlet Counter With Base Shelf (Sol)	900x750x890	0.6
AND.BYC.75120-T-R	Bulaşık Makinesi Çıkış Tezgahı Taban Rafı (Sağ) Dishwasher Outlet Counter With Base Shelf (Right)	1200x750x890	0.8
AND.BYC.75120-T-L	Bulaşık Makinesi Çıkış Tezgahı Taban Rafı (Sol) Dishwasher Outlet Counter With Base Shelf (Sol)	1200x750x890	0.8



Kod Code	Ürün Adı Description	Ebatlar Dimension a x b x c (mm)	Net Net (m ³)
AND.BYG.7560-1ET-R-K	Bulaşık Makinesi Giriş Tezgahı Tek Evyeli Taban Rafı (Sağ) Dishwasher Inlet Bench Single Sink With Base Shelf (Right)	600x750x890	0.4
AND.BYG.7560-1ET-L-K	Bulaşık Makinesi Giriş Tezgahı Tek Evyeli Taban Rafı (Sol) Dishwasher Inlet Bench Single Sink With Base Shelf (Left)	600x750x890	0.4
AND.BYG.7590-1ET-R-K	Bulaşık Makinesi Giriş Tezgahı Tek Evyeli Taban Rafı (Sağ) Dishwasher Inlet Bench Single Sink With Base Shelf (Right)	900x750x890	0.6
AND.BYG.7590-1ET-L-K	Bulaşık Makinesi Giriş Tezgahı Tek Evyeli Taban Rafı (Sol) Dishwasher Inlet Bench Single Sink With Base Shelf (Left)	900x750x890	0.6
AND.BYG.75120-1ET-R-K	Bulaşık Makinesi Giriş Tezgahı Tek Evyeli Taban Rafı (Sağ) Dishwasher Inlet Bench Single Sink With Base Shelf (Right)	1200x750x890	0.8
AND.BYG.75120-1ET-L-K	Bulaşık Makinesi Giriş Tezgahı Tek Evyeli Taban Rafı (Sol) Dishwasher Inlet Bench Single Sink With Base Shelf (Left)	1200x750x890	0.8
AND.BYG.75150-1EC-R-K	Bulaşık Makinesi Giriş Tezgahı Tek Evyeli Taban Rafı (Sağ) Dishwasher Inlet Bench Single Sink With Base Shelf (Right)	1500x750x890	1
AND.BYG.75150-1EC-L-K	Bulaşık Makinesi Giriş Tezgahı Tek Evyeli Taban Rafı (Sol) Dishwasher Inlet Bench Single Sink With Base Shelf (Left)	1500x750x890	1
AND.BYC.7560-T-R-K	Bulaşık Makinesi Çıkış Tezgahı Taban Rafı (Sağ) Dishwasher Outlet Counter With Base Shelf (Right)	600x750x890	0.4
AND.BYC.7560-T-L-K	Bulaşık Makinesi Çıkış Tezgahı Taban Rafı (Sol) Dishwasher Outlet Counter With Base Shelf (Sol)	600x750x890	0.4
AND.BYC.7590-T-R-K	Bulaşık Makinesi Çıkış Tezgahı Taban Rafı (Sağ) Dishwasher Outlet Counter With Base Shelf (Right)	900x750x890	0.6
AND.BYC.7590-T-L-K	Bulaşık Makinesi Çıkış Tezgahı Taban Rafı (Sol) Dishwasher Outlet Counter With Base Shelf (Sol)	900x750x890	0.6
AND.BYC.75120-T-R-K	Bulaşık Makinesi Çıkış Tezgahı Taban Rafı (Sağ) Dishwasher Outlet Counter With Base Shelf (Right)	1200x750x890	0.8
AND.BYC.75120-T-L-K	Bulaşık Makinesi Çıkış Tezgahı Taban Rafı (Sol) Dishwasher Outlet Counter With Base Shelf (Sol)	1200x750x890	0.8



www.turkeyner.com

Snack Serisi

Snack Series



andora

andora

SNACK SERİSİ

Yüksek Yanırlı Gazlı Ocaklar
Ocaklar
Fritözler
Gazlı Izgaralar
Gazlı Izgaralar (Krom Pleyt)
Elektrikli Izgaralar
Elektrikli Izgaralar (Krom Pleyt)
Gazlı Sulu Izgaralar
Elektrikli Sulu Izgaralar
Gazlı Lavataşlı Izgaralar
Elektrikli Makarna Haşlama - Patates Dinlendirme Üniteleri
Elektrikli Benmariler
Set Altı Tezgahlar
Ara Tezgahlar

SNACK SERIES

High Pressure Gas Cookers
Cookers
Fryers
Gas Grills
Gas Grills (Chrome Plate)
Electrical Grills
Electrical Grills (Chrome Plate)
Gas Vapor Grills
Electrical Vapor Grills
Gas Lavastone Grills
Electrical Pasta Cooker - Chips Scuttle Units
Electrical Bainmaries
Undercounter Cabinets
Worktop



Yüksek yanışlı pişirme için / High pressure cooking



Kod Code	Ürün Adı Description	Ebatlar Dimension	Ağırlık Weight	Net Net	Güç Power
		a x b x c (mm)	(kg)	(m ³)	(kw)
AND.6KG010-0	Yüksek Yanışlı Gazlı Ocak 1 Brülörlü High Pressure Gas Cooker 1 Burner	400x635x285	25	0.1	8.65
AND.6KG020-0	Yüksek Yanışlı Gazlı Ocak 2 Brülörlü High Pressure Gas Cooker 2 Burners	800x635x285	47	0.2	17.30

TEKNİK ÖZELLİKLER

- Lpg ve Ng ile çalışabilme özelliği.
- Magnet emniyet ventilli musluklar.
- Kademeli şalter.
- Çift yanışlı brülör.
- Kolay temizlenebilir ve hijyeniktir.
- Paslanmaz çelik gövde.

AND.6KG010-0

- Gaz Tüketim Değeri (ng): 0,91 m³/h
- Gaz Tüketim Değeri (lpg): 0,68 kg/h

AND.6KG020-0

- Gaz Tüketim Değeri (ng): 1,83 m³/h
- Gaz Tüketim Değeri (lpg): 1,19 kg/h

TECHNICAL SPECIFICATIONS

- Lpg or Natural Gas.
- Magnet safety valves.
- Positioned switch.
- Double ring burner.
- Easy to clean and hygienic.
- Stainless steel body.

AND.6KG010-0

- Gas Consumption (ng): 0,91 m³/h
- Gas Consumption (lpg): 0,68 kg/h

AND.6KG020-0

- Gas Consumption (ng): 1,83 m³/h
- Gas Consumption (lpg): 1,19 kg/h

Snack Serisi Snack Series

Ocaklar Cookers

andora



Kod Code	Ürün Adı Description	Ebatlar Dimension	Ağırlık Weight	Net Net	Güç Power
		a x b x c (mm)	(kg)	(m ³)	(kw)
AND.6KG010	Gazlı Ocak 2 Brülörlü Gas Cooker 2 Burners	400x635x285	22	0.11	7.1
AND.6KG020	Gazlı Ocak 4 Brülörlü Gas Cooker 4 Burners	600x635x285	32	0.17	14.2

TEKNİK ÖZELLİKLER

- Magnet emniyet ventilli musluklar.
- Kademeli şalter.
- Çift yanışlı brülör.
- Her brülör için piezzo çakmak ile kontrol.
- Paslanmaz çelik gövde.

TECHNICAL SPECIFICATIONS

- Magnet safety valves.
- Positioned switch.
- Double ring burner.
- Piezo electric ignition system for each module.
- Stainless steel body.

AND.6KG010

- Gaz Tüketim Değeri (ng): 0,75 m³/h
- Gaz Tüketim Değeri (lpg): 0,55 kg/h

AND.6KG010

- Gas Consumption (ng): 0,75 m³/h
- Gas Consumption (lpg): 0,55 kg/h

AND.6KG020

- Gaz Tüketim Değeri (ng): 1,5 m³/h
- Gaz Tüketim Değeri (lpg): 1,1 kg/h

AND.6KG020

- Gas Consumption (ng): 1,5 m³/h
- Gas Consumption (lpg): 1,1 kg/h

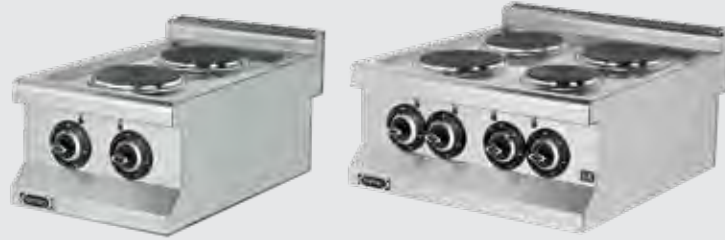

Kod Code	Ürün Adı Description	Ebatlar Dimension	Ağırlık Weight	Net Net	Güç Power
		a x b x c (mm)	(kg)	(m ³)	(kw)
AND.6KE010	Elektrikli Ocak 2 Yuvarlak Pleytli Electrical Cooker 2 Circle Plates	400x635x285	19	0.11	3.5
AND.6KE020	Elektrikli Ocak 4 Yuvarlak Pleytli Electrical Cooker 4 Circle Plates	600x635x285	24	0.17	7

TEKNİK ÖZELLİKLER

- 6 kademeli şalter.
- Kolay temizlenebilir ve hijyeniktir.
- Paslanmaz çelik gövde.

TECHNICAL SPECIFICATIONS

- 6 position switch.
- Easy to clean and hygienic.
- Stainless steel body.

AND.6KE010

- Elektrik Girişi: 230V AC 1N PE
- Kablo Kesiti (mm²): 3x2,5

AND.6KE010

- Electric Input: 230V AC 1N PE
- Cable Cross Section (mm²): 3x2,5

AND.6KE020

- Elektrik Girişi: 400V AC 3N PE
- Kablo Kesiti (mm²): 5x2,5

AND.6KE020

- Electric Input: 400V AC 3N PE
- Cable Cross Section (mm²): 5x2,5



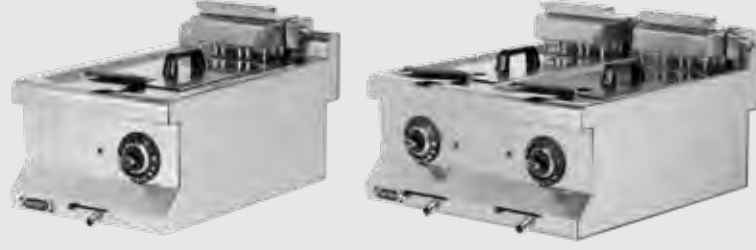

Kod Code	Ürün Adı Description	Ebatlar Dimension	Ağırlık Weight	Net Net	Güç Power	Kapasite Capacity
		a x b x c (mm)	(kg)	(m ³)	(kw)	(lt)
AND.6FE010	Elektrikli Fritöz Electrical Fryer	400x635x285	24	0.11	7.2	10
AND.6FE020	Elektrikli Fritöz Electrical Fryer	600x635x285	36	0.17	14.4	10+10

TEKNİK ÖZELLİKLER

- Termostatik kontrol.
- Hareketli ısıtıcılar kolay temizlik imkanı sağlar.
- Tahliye musluğu ile emniyetli yağ boşaltma.
- Limit termostat.
- Paslanmaz çelik gövde ve sepetler.

TECHNICAL SPECIFICATIONS

- Thermostatic controller.
- Moving heaters provide easy cleaning.
- Front oil drainage valve.
- Safety thermostat for overheating protection.
- Stainless steel body and baskets.

AND.6FE010

- Elektrik Girişi: 400V AC 3N PE
- Kablo Kesiti (mm²): 5x2,5

AND.6FE010

- Electric Input: 400V AC 3N PE
- Cable Cross Section (mm²): 5x2,5

AND.6FE020

- Elektrik Girişi: 400V AC 3N PE
- Kablo Kesiti (mm²): 5x2,5

AND.6FE020

- Electric Input: 400V AC 3N PE
- Cable Cross Section (mm²): 5x2,5



Kod Code	Ürün Adı Description	Ebatlar Dimension	Ağırlık Weight	Net Net	Güç Power	Kapasite Capacity
		a x b x c (mm)	(kg)	(m ³)	(kw)	(lt)
AND.6FG010	Gazlı Fritöz Gas Fryer	400x635x285	25	0.11	4.34	12
AND.6FG020	Gazlı Fritöz Gas Fryer	600x635x285	32	0.17	8.67	10+10

TEKNİK ÖZELLİKLER

- Lpg ve Ng ile çalışabilme özelliği.
- Magnet emniyet ventilli musluklar.
- Tahliye musluğu ile emniyetli yağ boşaltma.
- Limit termostat.
- Paslanmaz çelik gövde ve sepetler.

TECHNICAL SPECIFICATIONS

- Lpg or Natural Gas.
- Magnet safety valves.
- Front oil drainage valve.
- Safety thermostat for overheating protection.
- Stainless steel body and baskets.

AND.6FG010

- Gaz Tüketim Değeri (ng): 0.46 m³/h
- Gaz Tüketim Değeri (lpg): 0.39 kg/h

AND.6FG010

- Gas Consumption (ng): 0.46 m³/h
- Gas Consumption (lpg): 0.39 kg/h

AND.6FG020

- Gaz Tüketim Değeri (ng): 0.92 m³/h
- Gaz Tüketim Değeri (lpg): 0.78 kg/h

AND.6FG020

- Gas Consumption (ng): 0.92 m³/h
- Gas Consumption (lpg): 0.78 kg/h



Snack Serisi Snack Series

Gazlı Izgaralar Gas Grills

andora

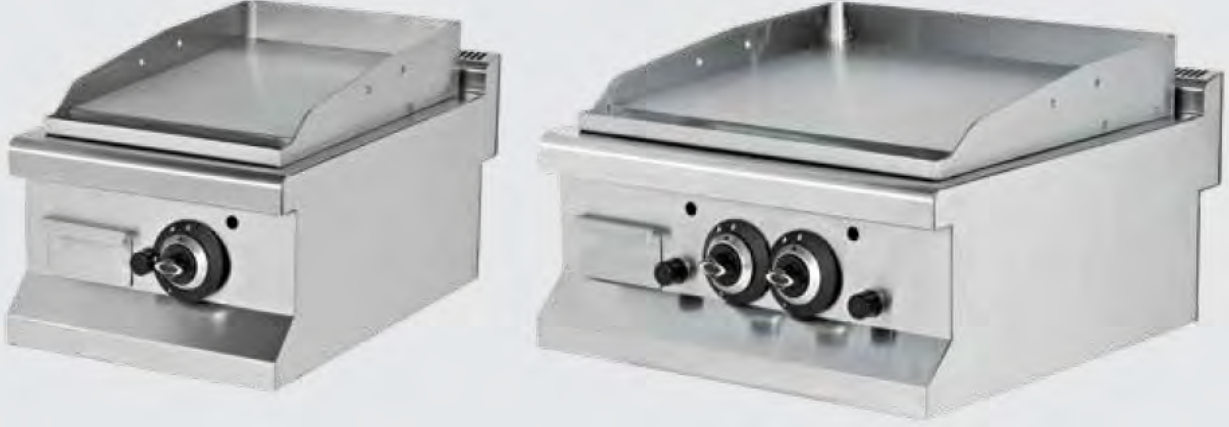

Kod Code	Ürün Adı Description	Ebatlar Dimension a x b x c (mm)	Ağırlık Weight (kg)	Net Net (m ³)	Güç Power (kw)
AND.6IG010	Gazlı Izgara Düz Pleyt Gas Grill Smooth Plate	400x635x285	41	0.11	6.5
AND.6IG011	Gazlı Izgara Komple Oluklu Pleyt Gas Grill Ribbed Plate	400x635x285	41	0.11	6.5
AND.6IG020	Gazlı Izgara Düz Pleyt Gas Grill Smooth Plate	600x635x285	52	0.17	13
AND.6IG021	Gazlı Izgara Komple Oluklu Pleyt Gas Grill Ribbed Plate	600x635x285	52	0.17	13
AND.6IG022	Gazlı Izgara Düz+Oluklu Pleyt Gas Grill Smooth+Ribbed Plate	600x635x285	52	0.17	13
AND.6IG030	Gazlı Izgara Düz Pleyt Gas Grill Smooth Plate	900x635x285	84	0.24	19.5
AND.6IG031	Gazlı Izgara Komple Oluklu Pleyt Gas Grill Ribbed Plate	900x635x285	84	0.24	19.5
AND.6IG032	Gazlı Izgara Düz+Oluklu Pleyt Gas Grill Smooth+Ribbed Plate	900x635x285	84	0.24	19.5

TEKNİK ÖZELLİKLER

- Lpg ve Ng ile çalışabilme özelliği.
- Magnet emniyet ventilli ve pilotlu musluklar.
- Tam modüllerde iki bölgeyi pişirme.
- Her brülör için piezzo çakmak ile kontrol.
- Çıkarılabilir yağ toplama haznesi.
- Üst tabla kalınlığı 1.2 mm, gövde 1 mm paslanmaz çelik.

TECHNICAL SPECIFICATIONS

- Lpg or Natural Gas.
- Magnet safety valves with pilot.
- Two separate heating zones.
- Piezo electric ignition system for each module.
- Removable oil collection drawer.
- Top plate thickness 1.2 mm, body 1 mm stainless steel.

AND.6IG010 / AND.6IG011

- Gaz Tüketim Değeri (ng): 0,68 m³/h
- Gaz Tüketim Değeri (lpg): 0,43 kg/h

AND.6IG020 / AND.6IG021 / AND.6IG022

- Gaz Tüketim Değeri (ng): 1,37 m³/h
- Gaz Tüketim Değeri (lpg): 0,86 kg/h

AND.6IG030 / AND.6IG031 / AND.6IG032

- Gaz Tüketim Değeri (ng): 2,06 m³/h
- Gaz Tüketim Değeri (lpg): 1,29 kg/h

AND.6IG010 / AND.6IG011

- Gas Consumption (ng): 0,68 m³/h
- Gas Consumption (lpg): 0,43 kg/h

AND.6IG020 / AND.6IG021 / AND.6IG022

- Gas Consumption (ng): 1,37 m³/h
- Gas Consumption (lpg): 0,86 kg/h

AND.6IG030 / AND.6IG031 / AND.6IG032

- Gas Consumption (ng): 2,06 m³/h
- Gas Consumption (lpg): 1,29 kg/h

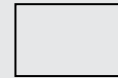

Düz / Smooth



Düz + Oluklu / Smooth + Ribbed



Komple Oluklu / Complete Ribbed

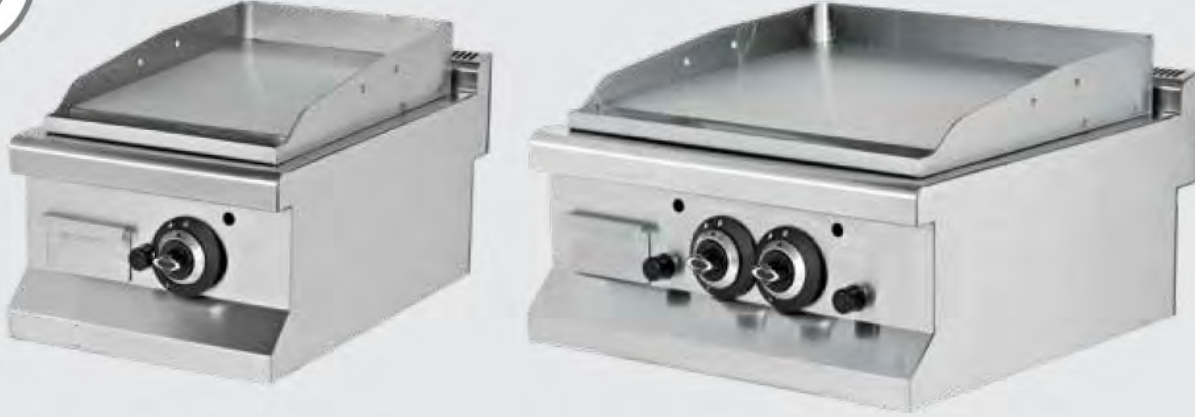

Kod Code	Ürün Adı Description	Ebatlar Dimension	Ağırlık Weight	Net Net	Güç Power
		a x b x c (mm)	(kg)	(m ³)	(kw)
AND.6IG010-K	Gazlı Izgara Düz Krom Pleyt Gas Grill Smooth Chrome Plate	400x635x285	41	0.11	6.5
AND.6IG011-K	Gazlı Izgara Komple Oluklu Krom Pleyt Gas Grill Ribbed Chrome Plate	400x635x285	41	0.11	6.5
AND.6IG020-K	Gazlı Izgara Düz Krom Pleyt Gas Grill Smooth Chrome Plate	600x635x285	52	0.17	13
AND.6IG021-K	Gazlı Izgara Komple Oluklu Krom Pleyt Gas Grill Ribbed Chrome Plate	600x635x285	52	0.17	13
AND.6IG022-K	Gazlı Izgara Düz+Oluklu Krom Pleyt Gas Grill Smooth+Ribbed Chrome Plate	600x635x285	52	0.17	13
AND.6IG030-K	Gazlı Izgara Düz Krom Pleyt Gas Grill Smooth Chrome Plate	900x635x285	84	0.24	19.5
AND.6IG031-K	Gazlı Izgara Komple Oluklu Krom Pleyt Gas Grill Ribbed Chrome Plate	900x635x285	84	0.24	19.5
AND.6IG032-K	Gazlı Izgara Düz+Oluklu Krom Pleyt Gas Grill Smooth+Ribbed Chrome Plate	900x635x285	84	0.24	19.5

TEKNİK ÖZELLİKLER

- Lpg ve Ng ile çalışabilme özelliği.
- Magnet emniyet ventilli ve pilotlu musluklar.
- Tam modüllerde iki bölgeyi pişirme.
- Her brülör için piezzo çakmak ile kontrol.
- Çıkarılabilir yağ toplama haznesi.
- Üst tabla kalınlığı 1.2 mm, gövde 1 mm paslanmaz çelik.

TECHNICAL SPECIFICATIONS

- Lpg or Natural Gas.
- Magnet safety valves with pilot.
- Two separate heating zones.
- Piezo electric ignition system for each module.
- Removable oil collection drawer.
- Top plate thickness 1.2 mm, body 1 mm stainless steel.



AND.6IG010-K / AND.6IG011-K

- Gaz Tüketim Değeri (ng): 0,68 m³/h
- Gaz Tüketim Değeri (lpg): 0,43 kg/h

AND.6IG010-K / AND.6IG011-K

- Gas Consumption (ng): 0,68 m³/h
- Gas Consumption (lpg): 0,43 kg/h



Düz / Smooth

AND.6IG020-K / AND.6IG021-K / AND.6IG022-K

- Gaz Tüketim Değeri (ng): 1,37 m³/h
- Gaz Tüketim Değeri (lpg): 0,86 kg/h

AND.6IG020-K / AND.6IG021-K / AND.6IG022-K

- Gas Consumption (ng): 1,37 m³/h
- Gas Consumption (lpg): 0,86 kg/h



Düz + Oluklu / Smooth + Ribbed

AND.6IG030-K / AND.6IG031-K / AND.6IG032-K

- Gaz Tüketim Değeri (ng): 2,06 m³/h
- Gaz Tüketim Değeri (lpg): 1,29 kg/h

AND.6IG030-K / AND.6IG031-K / AND.6IG032-K

- Gas Consumption (ng): 2,06 m³/h
- Gas Consumption (lpg): 1,29 kg/h



Komple Oluklu / Complete Ribbed

Snack Serisi Snack Series

Elektrikli Izgaralar Electrical Grills

andora

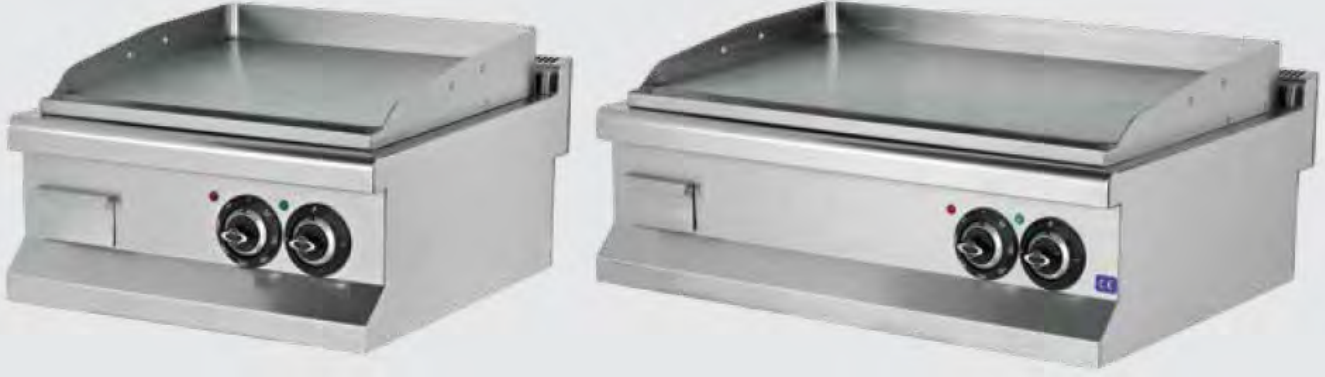

Kod Code	Ürün Adı Description	Ebatlar Dimension	Ağırlık Weight	Net Net	Güç Power
		a x b x c (mm)	(kg)	(m³)	(kw)
AND.6IE010	Elektrikli Izgara Düz Pleyt Electrical Grill Smooth Plate	400x635x285	45	0.11	3.6
AND.6IE011	Elektrikli Izgara Komple Oluklu Pleyt Electrical Grill Ribbed Plate	400x635x285	45	0.11	3.6
AND.6IE020	Elektrikli Izgara Düz Pleyt Electrical Grill Smooth Plate	600x635x285	58	0.17	7.2
AND.6IE021	Elektrikli Izgara Komple Oluklu Pleyt Electrical Grill Ribbed Plate	600x635x285	58	0.17	7.2
AND.6IE022	Elektrikli Izgara Düz+Oluklu Pleyt Electrical Grill Smooth+Ribbed Plate	600x635x285	58	0.17	7.2
AND.6IE030	Elektrikli Izgara Düz Pleyt Electrical Grill Smooth Plate	900x635x285	87	0.24	10.8
AND.6IE031	Elektrikli Izgara Komple Oluklu Pleyt Electrical Grill Ribbed Plate	900x635x285	87	0.24	10.8
AND.6IE032	Elektrikli Izgara Düz+Oluklu Pleyt Electrical Grill Smooth+Ribbed Plate	900x635x285	87	0.24	10.8

TEKNİK ÖZELLİKLER

- Termostatik kontrol.
- Tam modüllerde iki bölgeyi ısıtma.
- Çıkarılabilir yağ toplama haznesi.
- Kolay temizlenebilir ve hijyeniktir.
- Üst tabla kalınlığı 1.2 mm, gövde 1 mm paslanmaz çelik.
- Limit termostat.

TECHNICAL SPECIFICATIONS

- Thermostatic controller.
- Two separate heating zones.
- Removable oil collection drawer.
- Easy to clean and hygienic.
- Top plate thickness 1.2 mm, body 1 mm stainless steel.
- Limit thermostat.

AND.6IE010 / AND.6IE011

- Elektrik Girişi: 400V AC 3N PE
- Kablo Kesiti (mm²): 5x2,5

AND.6IE020 / AND.6IE021 / AND.6IE022

- Elektrik Girişi: 400V AC 3N PE
- Kablo Kesiti (mm²): 5x2,5

AND.6IE030 / AND.6IE031 / AND.6IE032

- Elektrik Girişi: 400V AC 3N PE
- Kablo Kesiti (mm²): 5x4

AND.6IE010 / AND.6IE011

- Electric Input: 400V AC 3N PE
- Cable Cross Section (mm²): 5x2,5

AND.6IE020 / AND.6IE021 / AND.6IE022

- Electric Input: 400V AC 3N PE
- Cable Cross Section (mm²): 5x2,5

AND.6IE030 / AND.6IE031 / AND.6IE032

- Electric Input: 400V AC 3N PE
- Cable Cross Section (mm²): 5x4

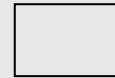

Düz / Smooth



Düz + Oluklu / Smooth + Ribbed



Komple Oluklu / Complete Ribbed

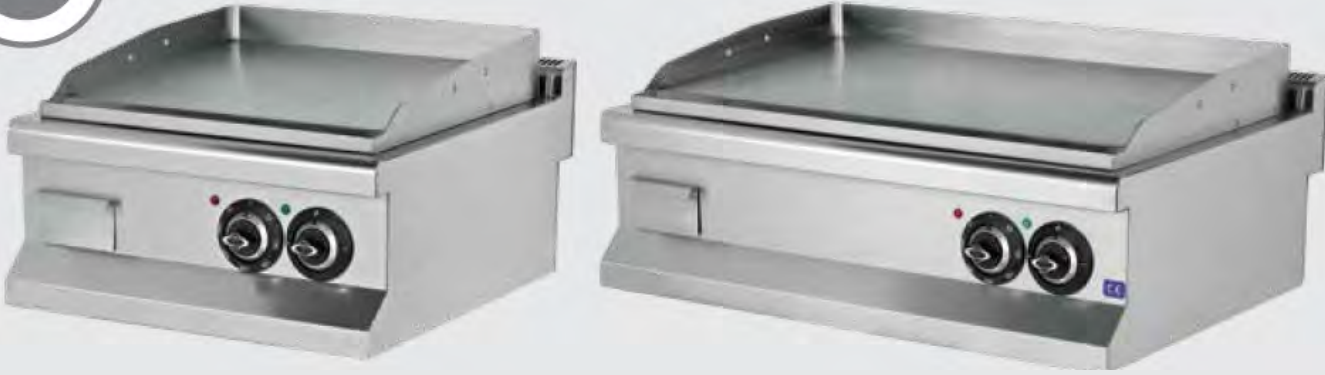

Kod Code	Ürün Adı Description	Ebatlar Dimension	Ağırlık Weight	Net Net	Güç Power
		a x b x c (mm)	(kg)	(m ³)	(kw)
AND.6IE010-K	Elektrikli Izgara Düz Krom Pleyt Electrical Grill Smooth Chrome Plate	400x635x285	45	0.11	3.6
AND.6IE011-K	Elektrikli Izgara Komple Oluklu Pleyt Electrical Grill Ribbed Plate	400x635x285	45	0.11	3.6
AND.6IE020-K	Elektrikli Izgara Düz Krom Pleyt Electrical Grill Smooth Chrome Plate	600x635x285	58	0.17	7.2
AND.6IE021-K	Elektrikli Izgara Komple Oluklu Krom Pleyt Electrical Grill Ribbed Chrome Plate	600x635x285	58	0.17	7.2
AND.6IE022-K	Elektrikli Izgara Düz+Oluklu Krom Pleyt Electrical Grill Smooth+Ribbed Chrome Plate	600x635x285	58	0.17	7.2
AND.6IE030-K	Elektrikli Izgara Düz Krom Pleyt Electrical Grill Smooth Chrome Plate	900x635x285	87	0.24	10.8
AND.6IE031-K	Elektrikli Izgara Komple Oluklu Pleyt Electrical Grill Ribbed Plate	900x635x285	87	0.24	10.8
AND.6IE032-K	Elektrikli Izgara Düz+Oluklu Krom Pleyt Electrical Grill Smooth+Ribbed Chrome Plate	900x635x285	87	0.24	10.8

TEKNİK ÖZELLİKLER

- Termostatik kontrol.
- Tam modüllerde iki bölgeyi ısıtma.
- Çıkarılabilir yağ toplama haznesi.
- Kolay temizlenebilir ve hijyeniktir.
- Üst tabla kalınlığı 1.2 mm, gövde 1 mm paslanmaz çelik.
- Limit termostat.

TECHNICAL SPECIFICATIONS

- Thermostatic controller.
- Two separate heating zones.
- Removable oil collection drawer.
- Easy to clean and hygienic.
- Top plate thickness 1.2 mm, body 1 mm stainless steel.
- Limit thermostat.

AND.6IE010-K / AND.6IE011-K

- Elektrik Girişi: 400V AC 3N PE
- Kablo Kesiti (mm²): 5x2,5

AND.6IE020-K / AND.6IE021-K / AND.6IE022-K

- Elektrik Girişi: 400V AC 3N PE
- Kablo Kesiti (mm²): 5x2,5

AND.6IE030-K / AND.6IE031-K / AND.6IE032-K

- Elektrik Girişi: 400V AC 3N PE
- Kablo Kesiti (mm²): 5x4

AND.6IE010-K / AND.6IE011-K

- Elektrik Input: 400V AC 3N PE
- Cable Cross Section (mm²): 5x2,5

AND.6IE020-K / AND.6IE021-K / AND.6IE022-K

- Elektrik Input: 400V AC 3N PE
- Cable Cross Section (mm²): 5x2,5

AND.6IE030-K / AND.6IE031-K / AND.6IE032-K

- Elektrik Input: 400V AC 3N PE
- Cable Cross Section (mm²): 5x4



Düz / Smooth



Düz + Oluklu / Smooth + Ribbed



Komple Oluklu / Complete Ribbed

Snack Serisi Snack Series

Gazlı Sulu Izgaralar Gas Vapor Grills

andora



**Bu ürün için lütfen 700 plus seri setalti dolapları kullanınız
Please use 700 plus serie cabinets for this product range.**



Kod Code	Ürün Adı Description	Ebatlar Dimension	Ağırlık Weight	Net Net	Güç Power
		a x b x c (mm)	(kg)	(m ³)	(kw)
AND.6LG010-S	Gazlı Sulu Izgara Gas Vapor Grill	400x730x285	48	0.11	5.2
AND.6LG020-S	Gazlı Sulu Izgara Gas Vapor Grill	800x730x285	94	0.17	10.4
AND.6LG030-S	Gazlı Sulu Izgara Gas Vapor Grill	1200x730x285	137	0.25	15.6

TEKNİK ÖZELLİKLER

- Buharlaştırma kabini sayesinde daha verimli pişirme.
- Lpg ve Ng ile çalışabilme özelliği.
- Magnet emniyet ventilli ve pilotlu musluklar.
- Tam modüllerde iki bölgeyi ısıtma.
- Her brülör için piezzo çakmak ile kontrol.
- Pik döküm ızgara.
- Üst tabla kalınlığı 1.5 mm, gövde 1 mm paslanmaz çelik.

TECHNICAL SPECIFICATIONS

- Steamer cabinet provides fertile cooking.
- Lpg or Natural Gas.
- Magnet safety valves with pilot.
- Two separate heating zones.
- Piezo electric ignition system for each module.
- Cast iron plate.
- Top plate thickness 1.5 mm, body 1 mm stainless steel.

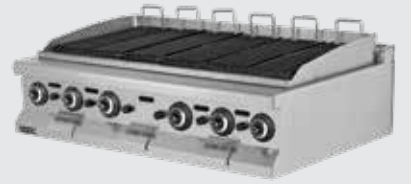

AND.6LG010-S

- Gaz Tüketim Değeri (ng): 0,55 m³/h
- Gaz Tüketim Değeri (lpg): 0,60 kg/h

AND.6LG020-S

- Gaz Tüketim Değeri (ng): 1,10m³/h
- Gaz Tüketim Değeri (lpg): 1,20 kg/h

AND.6LG030-S

- Gaz Tüketim Değeri (ng): 1,65 m³/h
- Gaz Tüketim Değeri (lpg): 1,80 kg/h

AND.6LG010-S

- Gas Consumption (ng): 0,55 m³/h
- Gas Consumption (lpg): 0,60 kg/h

AND.6LG020-S

- Gas Consumption (ng): 1,10 m³/h
- Gas Consumption (lpg): 1,20 kg/h

AND.6LG030-S

- Gas Consumption (ng): 1,65 m³/h
- Gas Consumption (lpg): 1,80 kg/h



Kod Code	Ürün Adı Description	Ebatlar Dimension a x b x c (mm)	Ağırlık Weight (kg)	Net Net (m ³)	Güç Power (kw)
AND.6LE010	Elektrikli Sulu Izgara Electrical Vapor Grill	400x600x290	27	0.11	3.75
AND.6LE020	Elektrikli Sulu Izgara Electrical Vapor Grill	600x600x290	36	0.11	6.25
AND.6LE030	Elektrikli Sulu Izgara Electrical Vapor Grill	800x600x290	46	0.24	8.75
AND.6LE040	Elektrikli Sulu Izgara Electrical Vapor Grill	1200x600x290	57	0.25	13.75

TEKNİK ÖZELLİKLER

- Buharlaştırma kabini sayesinde daha verimli pişirme.
- Kolay kaldırılabilir rezistanslar sayesinde kolay temizlik imkanı.
- Daha kısa sürede daha az enerji ile pişirme imkanı.
- Kolay temizlenebilir ve hijyeniktir.
- Üst tabla kalınlığı 1.2 mm, gövde 1 mm paslanmaz çelik.

TECHNICAL SPECIFICATIONS

- Steamer cabinet provides fertile cooking.
- Easy tilting heaters provide easy cleaning.
- Faster cooking with low energy.
- Easy to clean and hygienic.
- Top plate thickness 1.2 mm, body 1 mm stainless steel.

AND.6LE010

- Elektrik Girişi: 400V AC 3N PE
- Kablo Kesiti (mm²): 5x2,5

AND.6LE020

- Elektrik Girişi: 400V AC 3N PE
- Kablo Kesiti (mm²): 5x2,5

AND.6LE030

- Elektrik Girişi: 400V AC 3N PE
- Kablo Kesiti (mm²): 5x2,5

AND.6LE040

- Elektrik Girişi: 400V AC 3N PE
- Kablo Kesiti (mm²): 5x2,5

AND.6LE010

- Electric Input: 400V AC 3N PE
- Cable Cross Section (mm²): 5x2,5

AND.6LE020

- Electric Input: 400V AC 3N PE
- Cable Cross Section (mm²): 5x2,5

AND.6LE030

- Electric Input: 400V AC 3N PE
- Cable Cross Section (mm²): 5x2,5

AND.6LE040

- Electric Input: 400V AC 3N PE
- Cable Cross Section (mm²): 5x2,5

Snack Serisi Snack Series

Gazlı Lavataşlı Izgaralar Gas Lavastone Grills

andora

CE



Kod Code	Ürün Adı Description	Ebatlar Dimension a x b x c (mm)	Ağırlık Weight (kg)	Net Net (m ³)	Güç Power (kw)
AND.6LG010	Gazlı Lavataşlı Izgara Gas Lavastone Grill	400x635x285	51	0.11	6.46
AND.6LG020	Gazlı Lavataşlı Izgara Gas Lavastone Grill	600x635x285	72	0.17	12.9
AND.6LG030	Gazlı Lavataşlı Izgara Gas Lavastone Grill	900x635x285	104	0.24	19.38

TEKNİK ÖZELLİKLER

- Lpg ve Ng ile çalışabilme özelliği.
- Magnet emniyet ventilli ve pilotlu musluklar.
- Tam modüllerde iki bölgeyi ısıtma.
- Her brülör için piezzo çakmak ile kontrol.
- Çıkarılabilir yağ toplama haznesi.
- Kolay temizlenebilir ve hijyeniktir.
- Üst tabla kalınlığı 1.2 mm, gövde 1 mm paslanmaz çelik.

TECHNICAL SPECIFICATIONS

- Lpg or Natural Gas.
- Magnet safety valves with pilot.
- Two separate heating zones.
- Piezo electric ignition system for each module.
- Removable oil collection drawer.
- Easy to clean and hygienic.
- Top plate thickness 1.2 mm, body 1 mm stainless steel.



AND.6LG010

- Gaz Tüketim Değeri (ng): 0,68 m³/h
- Gaz Tüketim Değeri (lpg): 0,43 kg/h

AND.6LG020

- Gaz Tüketim Değeri (ng): 1,36 m³/h
- Gaz Tüketim Değeri (lpg): 0,86 kg/h

AND.6LG030

- Gaz Tüketim Değeri (ng): 2,04 m³/h
- Gaz Tüketim Değeri (lpg): 1,29 kg/h

AND.6LG010

- Gas Consumption (ng): 0,68 m³/h
- Gas Consumption (lpg): 0,43 kg/h

AND.6LG020

- Gas Consumption (ng): 1,36 m³/h
- Gas Consumption (lpg): 0,86 kg/h

AND.6LG030

- Gas Consumption (ng): 2,04 m³/h
- Gas Consumption (lpg): 1,29 kg/h



Kod Code	Ürün Adı Description	Ebatlar Dimension	Ağırlık Weight	Net Net	Güç Power	Kapasite Capacity
		a x b x c (mm)	(kg)	(m ³)	(kw)	(lt)
AND.6ME010	Elektrikli Makarna Haşlama Electrical Pasta Cooker	400x635x285	20	0.11	4.5	10

TEKNİK ÖZELLİKLER

- Termostatik kontrol.
- Su doldurma musluğu.
- Tahliye musluğu ile su boşaltma.
- Taşan su tahliye sistemi.
- Üst tabla kalınlığı 1.2 mm, gövde 1 mm paslanmaz çelik.

TECHNICAL SPECIFICATIONS

- Thermostatic controller.
- Water filling tap.
- Discharge valve.
- Overflow drainage system.
- Top plate thickness 1.2 mm, body 1 mm stainless steel.

AND.6ME010

- Elektrik Girişi: 400V AC 3N PE
- Kablo Kesiti (mm²): 5x2,5

AND.6ME010

- Electric Input: 400V AC 3N PE
- Cable Cross Section (mm²): 5x2,5



Kod Code	Ürün Adı Description	Ebatlar Dimension	Ağırlık Weight	Net Net	Güç Power	Kapasite Capacity
		a x b x c (mm)	(kg)	(m ³)	(kw)	(gn)
AND.6DE010	Patates Dinlendirme Ünitesi Chips Scuttle Unit	400x635x285	15	0.11	0.65	1/1x150

TEKNİK ÖZELLİKLER

- Kızartılmış patateslerin sıcak bekletilmesinde ve yağların süzülmesinde kullanılır.
- Infrared seramik ısıtıcı.
- Havuzda kızartma yağının süzülmesi için maksimum verim sağlayan özel form.
- Üst tabla kalınlığı 1.2 mm, gövde 1 mm paslanmaz çelik.

TECHNICAL SPECIFICATIONS

- Operates in order to keep fries warm and drain oil.
- Infrared ceramic heater.
- Special form on the container, provides maximum efficiency in order to drain oil.
- Top plate thickness 1.2 mm, body 1 mm stainless steel.

AND.6DE010

- Elektrik Girişi: 230V AC 3N PE
- Kablo Kesiti (mm²): 3x1,5

AND.6DE010

- Electric Input: 230V AC 3N PE
- Cable Cross Section (mm²): 3x1,5

Snack Serisi Snack Series

Elektrikli Benmariler Electrical Bainmaries

andora



Kod Code	Ürün Adı Description	Ebatlar Dimension	Ağırlık Weight	Net Net	Güç Power
		a x b x c (mm)	(kg)	(m ³)	(kw)
AND.6SE010	Elektrikli Benmari Electrical Bainmarie	400x635x285	19	0.11	1.5
AND.6SE020	Elektrikli Benmari Electrical Bainmarie	600x635x285	26	0.17	3

TEKNİK ÖZELLİKLER

- Termostatik kontrol.
- Tahliye musluğu.
- Kolay temizlenebilir ve hijyeniktir.
- Üst tabla kalınlığı 1.2 mm, gövde 1 mm paslanmaz çelik.

AND.6SE010

- Kapasite; 1 adet 2/3 Gn + 2 adet 1/6 Gn

AND.6SE020

- Kapasite; 1 adet 1/1 Gn + 2 adet 1/4 Gn

TECHNICAL SPECIFICATIONS

- Thermostatic controller.
- Drainage valve.
- Easy to clean and hygienic.
- Top plate thickness 1.2 mm, body 1 mm stainless steel.

AND.6SE010

- Capacity; 1 piece of 2/3 Gn + 2 pieces of 1/6 Gn

AND.6SE020

- Capacity; 1 piece 1/1 Gn + 2 pieces 1/4 Gn.

AND.6SE010

- Elektrik Girişi: 230V AC N PE
- Kablo Kesiti (mm²): 3x1,5

AND.6SE020

- Elektrik Girişi: 230V AC N PE
- Kablo Kesiti (mm²): 3x2,5

AND.6SE010

- Electric Input: 230V AC N PE
- Cable Cross Section (mm²): 3x1,5

AND.6SE020

- Electric Input: 230V AC N PE
- Cable Cross Section (mm²): 3x2,5

Standart üretimimizde küvet bulunmamaktadır.
Standart product does not have containers.



Kod Code	Ürün Adı Description	Ebatlar Dimension a x b x c (mm)	Ağırlık Weight (kg)	Net Net (m ³)
AND.TS010	Set Altı Tezgah 1 Kapaklı Undercounter Cabinet with 1 Door	400x570x565	18	0.15
AND.TS020	Set Altı Tezgah 2 Kapaklı Undercounter Cabinet with 2 Doors	600x570x565	21	0.22
AND.TS025	Set Altı Tezgah 2 Kapaklı Undercounter Cabinet with 2 Doors	800x570x565	26	0.25
AND.TS030	Set Altı Tezgah 3 Kapaklı Undercounter Cabinet with 3 Doors	900x570x565	28	0.33



Kod Code	Ürün Adı Description	Ebatlar Dimension a x b x c (mm)	Ağırlık Weight (kg)	Net Net (m ³)
AND.TS010-K	Set Altı Tezgah Kapaksız Undercounter Cabinet without Door	400x570x565	13	0.15
AND.TS020-K	Set Altı Tezgah Kapaksız Undercounter Cabinet without Door	600x570x565	16	0.22
AND.TS025-K	Set Altı Tezgah Kapaksız Undercounter Cabinet without Door	800x570x565	20	0.25
AND.TS030-K	Set Altı Tezgah Kapaksız Undercounter Cabinet without Door	900x570x565	23	0.33

TEKNİK ÖZELLİKLER

- Tezgahlar 60 seri cihazların altına kullanılabilecek uygun modüler ölçülerdedir.
- Kolay temizlenebilir ve hijyeniktir.
- Paslanmaz çelik gövde.

TECHNICAL SPECIFICATIONS

- Under-Set Counters are suitable to use under each kind of 60's serie equipments.
- Easy to clean and hygienic.
- Stainless steel body.

Snack Serisi Snack Series

Ara Tezgahlar Worktop

andora



Kod Code	Ürün Adı Description	Ebatlar Dimension	Ağırlık Weight	Net Net
		a x b x c (mm)	(kg)	(m ³)
AND.6TN010	Ara Tezgah 1/2 Modül Worktop 1/2 Module	400x635x285	13	0.11
AND.6TN020	Ara Tezgah 1/1 Modül Worktop 1/1 Module	600x635x285	20	0.17

TEKNİK ÖZELLİKLER

- Tezgahlar 60 seri cihazların arasında kullanılacak uygun modüler ölçülerdedir.
- Kolay temizlenebilir ve hijyeniktir.
- Üst tabla kalınlığı 1.2 mm, gövde 1 mm paslanmaz çelik.

TECHNICAL SPECIFICATIONS

- Worktops are suitable to use between each kind of 60's serie equipments.
- Easy to clean and hygienic.
- Top plate thickness 1.2 mm, body 1 mm stainless steel.

700 Plus Serisi
700 Plus Series

*PLUS



700 Plus Serisi
700 Plus Series

andora

andora

700 PLUS SERİSİ

Gazlı Ocaklar
Gazlı Wok Ocaklar
Gazlı Set Altı Fırınlar
Elektrikli Ocaklar (Yuvarlak Pleyt)
Elektrikli Ocaklar (Kare Pleyt)
Elektrikli İndüksiyon Ocaklar
Elektrikli Ocaklar (Rus Tipi Pleyt)
Elektrikli Set Altı Fırınlar
Elektrikli Fritözler
Gazlı Fritözler
Gazlı Fritözler Dolaplı
Gazlı Izgaralar
Gazlı Izgaralar (Krom Pleyt)
Elektrikli Izgaralar
Elektrikli Izgaralar (Krom Pleyt)
Gazlı Sulu Izgaralar
Elektrikli Sulu Izgaralar
Gazlı Lavataşlı Izgaralar
Amerikan Gazlı Lavataşlı Izgaralar
Elektrikli Benmariler
Elektrikli Makarna Haşlama - Patates Dinlendirme Üniteleri
Ara Tezgahlar
Set Altı Tezgahlar
Devrilir Tavalar
Kaynatma Tencereleri (İndirekt)
Cantilever Hat
Paslanmaz Alt Bazalar

700 PLUS SERIES

Gas Cookers
Gas Wok Cookers
Undercounter Gas Ovens
Electrical Cookers (Circle Plate)
Electrical Cookers (Square Plate)
Electrical Induction Cookers
Electrical Cookers (Russian Type Plate)
Electrical Undercounter Ovens
Electrical Fryers
Gas Fryers
Gas Fryers with Cupboard
Gas Grills
Gas Grills (Chrome Plate)
Electrical Grills
Electric Grills (Chrome Plate)
Gas Vapor Grills
Electrical Vapor Grills
Gas Lavastone Grills
American Gas Vapor Grills
Electrical Bainmaries
Electrical Pasta Cooker - Chips Scuttle Units
Worktops
Undercounter Cabinets
Tilting Pans
Boiling Pans (Indirect)
Cantilever Line
Stainless Steel Bases



Kod Code	Ürün Adı Description	Ebatlar Dimension	Ağırlık Weight	Net Net	Güç Power
		a x b x c (mm)	(kg)	(m ³)	(kw)
AND.PLS.7AKG010	Gazlı Ocak 2 Brülörlü Gas Cooker 2 Burners	400x730x300	34	0.09	14.3
AND.PLS.7AKG020	Gazlı Ocak 4 Brülörlü Gas Cooker 4 Burners	800x730x300	69	0.18	28.66
AND.PLS.7AKG030	Gazlı Ocak 6 Brülörlü Gas Cooker 6 Burners	1200x730x300	101	0.26	43

TEKNİK ÖZELLİKLER

- Lpg ve Ng ile çalışabilme özelliği.
- Magnet emniyet ventilli musluklar.
- Darbelere karşı dayanıklı üst döküm.
- Dökme demir çift yanışlı brülörler.
- Kolay temizlenebilir ve hijyeniktir.
- Paslanmaz çelik gövde.

TECHNICAL SPECIFICATIONS

- Lpg or Natural Gas.
- Magnet safety gas valve and thermocouple.
- Heavy duty top cast iron.
- Cast iron double burners.
- Easy to clean and hygienic.
- Stainless steel body.



AND.PLS.7AKG010

- Gaz Tüketim Değeri (ng): 1,51 m³/h
- Gaz Tüketim Değeri (lpg): 1,19 kg/h

AND.PLS.7AKG020

- Gaz Tüketim Değeri (ng): 3,03 m³/h
- Gaz Tüketim Değeri (lpg): 2,38 kg/h

AND.PLS.7AKG030

- Gaz Tüketim Değeri (ng): 4,55 m³/h
- Gaz Tüketim Değeri (lpg): 3,57 kg/h

AND.PLS.7AKG010

- Gas Consumption (ng): 1,51 m³/h
- Gas Consumption (lpg): 1,19 kg/h

AND.PLS.7AKG020

- Gas Consumption (ng): 3,03 m³/h
- Gas Consumption (lpg): 2,38 kg/h

AND.PLS.7AKG030

- Gas Consumption (ng): 4,55 m³/h
- Gas Consumption (lpg): 3,57 kg/h

700 Plus Serisi 700 Plus Series

Gazlı Wok Ocaklar Gas Wok Cookers

andora



Kod Code	Ürün Adı Description	Ebatlar Dimension	Ağırlık Weight	Net Net	Güç Power
		a x b x c (mm)	(kg)	(m ³)	(kw)
AND.PLS.7AWK010	Gazlı Wok Ocağı 1 Brülörlü Gas Wok Cooker 1 Burner	400x730x300	40	0.09	18
AND.PLS.7AWK020	Gazlı Wok Ocağı 2 Brülörlü Gas Wok Cooker 2 Burners	800x730x300	76	0.18	36
AND.PLS.7AWK030	Gazlı Wok Ocağı 3 Brülörlü Gas Wok Cooker 3 Burners	1200x730x300	107	0.26	54

TEKNİK ÖZELLİKLER

- Lpg ve Ng ile çalışabilme özelliği.
- Magnet emniyet ventilli musluklar.
- Darbelere karşı dayanıklı üst döküm.
- Her brülör için piezzo çakmak ile kontrol.
- Yüksek güçlü pik döküm brülörler yüksek sıcaklık sağlamaktadır.
- Kolay temizlenebilir ve hijyeniktir.
- Paslanmaz çelik gövde.

TECHNICAL SPECIFICATIONS

- Lpg or Natural Gas.
- Magnet safety gas valve and thermocouple.
- Heavy duty top cast iron.
- Piezo electric ignition system for each burner.
- High power cast iron burners provide the high temperature that is aimed to be reached.
- Easy to clean and hygienic.
- Stainless steel body.



AND.PLS.7AWK010

- Gaz Tüketim Değeri (ng): 1,9 m³/h
- Gaz Tüketim Değeri (lpg): 1,05 kg/h

AND.PLS.7AWK020

- Gaz Tüketim Değeri (ng): 3,8 m³/h
- Gaz Tüketim Değeri (lpg): 2,1 kg/h

AND.PLS.7AWK030

- Gaz Tüketim Değeri (ng): 5,6 m³/h
- Gaz Tüketim Değeri (lpg): 3,15 kg/h

AND.PLS.7AWK010

- Gas Consumption (ng): 1,9 m³/h
- Gas Consumption (lpg): 1,05 kg/h

AND.PLS.7AWK020

- Gas Consumption (ng): 3,8 m³/h
- Gas Consumption (lpg): 2,1 kg/h

AND.PLS.7AWK030

- Gas Consumption (ng): 5,6 m³/h
- Gas Consumption (lpg): 3,15 kg/h



Kod Code	Ürün Adı Description	Ebatlar Dimension	Ağırlık Weight	Net Net	Güç Power
		a x b x c (mm)	(kg)	(m ³)	(kw)
AND.PLS.7AFRG01	Gazlı Set Altı Fırın Undercounter Gas Oven	800x620x550	71	0.27	6.46
AND.PLS.7AFRG02	Gazlı Set Altı Fırın Undercounter Gas Oven	1200x620x550	83	0.41	6.46
AND.PLS.7AFRG03	Gazlı Set Altı Maxi Fırın Undercounter Gas Maxi Oven	1200x620x550	105	0.41	12.93

TEKNİK ÖZELLİKLER

- Lpg ve Ng ile çalışabilme özelliği.
- 2x2/1 Gn tepsi kapasiteli paslanmaz çelik fırın iç haznesi.
- Termostatik ayarlı fırın gaz ventilli.

TECHNICAL SPECIFICATIONS

- Lpg or Natural Gas
- 2x2/1 Gn capacity, stainless steel internal chamber.
- For oven:temperature control with thermostatic gas valve.

**AND.PLS.7AFRG01**

- Gaz Tüketim Değeri (ng): 0,68 m³/h
- Gaz Tüketim Değeri (lpg): 0,43 kg/h

AND.PLS.7AFRG01

- Gas Consumption (ng): 0,68 m³/h
- Gas Consumption (lpg): 0,43 kg/h

AND.PLS.7AFRG02

- Gaz Tüketim Değeri (ng): 0,68m³/h
- Gaz Tüketim Değeri (lpg): 0,43 kg/h

AND.PLS.7AFRG02

- Gas Consumption (ng): 0,68 m³/h
- Gas Consumption (lpg): 0,43 kg/h

AND.PLS.7AFRG03

- Gaz Tüketim Değeri (ng): 1,36 m³/h
- Gaz Tüketim Değeri (lpg): 0,87 kg/h

AND.PLS.7AFRG03

- Gas Consumption (ng): 1,36 m³/h
- Gas Consumption (lpg): 0,87 kg/h

700 Plus Serisi
700 Plus Series

Elektrikli Ocaklar (Yuvarlak Pleyt)
Electrical Cookers (Circle Plate)

andora



Kod Code	Ürün Adı Description	Ebatlar Dimension	Ağırlık Weight	Net Net	Güç Power
		a x b x c (mm)	(kg)	(m ³)	(kw)
AND.PLS.7AKE010-Y	Elektrikli Ocak 2 Yuvarlak Pleytli Electrical Cooker 2 Circle Plates	400x730x300	31	0.09	4
AND.PLS.7AKE020-Y	Elektrikli Ocak 4 Yuvarlak Pleytli Electrical Cooker 4 Circle Plates	800x730x300	55	0.18	8
AND.PLS.7AKE030-Y	Elektrikli Ocak 6 Yuvarlak Pleytli Electrical Cooker 6 Circle Plates	1200x730x300	78	0.26	12

TEKNİK ÖZELLİKLER

- 6 kademeli şalter.
- Kolay temizlenebilir ve hijyeniktir.
- Paslanmaz çelik gövde.

TECHNICAL SPECIFICATIONS

- 6 position switches.
- Easy to clean and hygienic.
- Stainless steel body.

AND.PLS.7AKE010-Y

- Elektrik Girişi: 230V AC N PE
- Kablo Kesiti (mm²): 3x2,5

AND.PLS.7AKE010-Y

- Electric Input: 230V AC N PE
- Cable Cross Section (mm²): 3x2,5

AND.PLS.7AKE020-Y

- Elektrik Girişi: 400V AC 3N PE
- Kablo Kesiti (mm²): 5x2,5

AND.PLS.7AKE020-Y

- Electric Input: 400V AC 3N PE
- Cable Cross Section (mm²): 5x2,5

AND.PLS.7AKE030-Y

- Elektrik Girişi: 400V AC 3N PE
- Kablo Kesiti (mm²): 5x4

AND.PLS.7AKE030-Y

- Electric Input: 400V AC 3N PE
- Cable Cross Section (mm²): 5x4





Kod Code	Ürün Adı Description	Ebatlar Dimension	Ağırlık Weight	Net Net	Güç Power
		a x b x c (mm)	(kg)	(m ³)	(kw)
AND.PLS.7AKE010	Elektrikli Ocak 2 Kare Pleytli Electrical Cooker 2 Square Plates	400x730x300	33	0.09	4.5
AND.PLS.7AKE020	Elektrikli Ocak 4 Kare Pleytli Electrical Cooker 4 Square Plates	800x730x300	57	0.18	9
AND.PLS.7AKE030	Elektrikli Ocak 6 Kare Pleytli Electrical Cooker 6 Square Plates	1200x730x300	80	0.26	13.5

TEKNİK ÖZELLİKLER

- 6 kademeli şalter.
- Kolay temizlenebilir ve hijyeniktir.
- Paslanmaz çelik gövde.

TECHNICAL SPECIFICATIONS

- 6 position switches.
- Easy to clean and hygienic.
- Stainless steel body.

**AND.PLS.7AKE010**

- Elektrik Girişi: 230V AC N PE
- Kablo Kesiti (mm²): 3x2,5

AND.PLS.7AKE010

- Electric Input: 230V AC N PE
- Cable Cross Section (mm²): 3x2,5

AND.PLS.7AKE020

- Elektrik Girişi: 400V AC 3N PE
- Kablo Kesiti (mm²): 5x2,5

AND.PLS.7AKE020

- Electric Input: 400V AC 3N PE
- Cable Cross Section (mm²): 5x2,5

AND.PLS.7AKE030

- Elektrik Girişi: 400V AC 3N PE
- Kablo Kesiti (mm²): 5x2,5

AND.PLS.7AKE030

- Electric Input: 400V AC 3N PE
- Cable Cross Section (mm²): 5x2,5

700 Plus Serisi 700 Plus Series

Elektrikli İndüksiyon Ocaklar Electrical Induction Cookers

andora



Kod Code	Ürün Adı Description	Ebatlar Dimension	Ağırlık Weight	Net Net	Güç Power
		a x b x c (mm)	(kg)	(m ³)	(kw)
AND.PLS.7AIND010	Elektrikli İndüksiyon Ocak 2'li Electrical Induction Cooker 2	400x730x300	28	0.09	6
AND.PLS.7AIND020	Elektrikli İndüksiyon Ocak 4'lü Electrical Induction Cooker 4	800x730x300	48	0.18	12
AND.PLS.7AIND030	Elektrikli İndüksiyon Ocak 6'lı Electrical Induction Cooker 6	1200x730x300	77	0.26	18

TEKNİK ÖZELLİKLER

- Cam pişirme yüzeyi.
- Kolay temizlenebilir ve hijyeniktir.
- Paslanmaz çelik gövde.

TECHNICAL SPECIFICATIONS

- Glass cooking surface.
- Easy to clean and hygienic.
- Stainless steel body.

AND.PLS.7AIND010

- Elektrik Girişi: 230V AC N PE
- Kablo Kesiti (mm²): 3x2,5

AND.PLS.7AIND020

- Elektrik Girişi: 400V AC 3N PE
- Kablo Kesiti (mm²): 5x4

AND.PLS.7AIND030

- Elektrik Girişi: 400V AC 3N PE
- Kablo Kesiti (mm²): 5x4

AND.PLS.7AIND010

- Electric Input: 230V AC N PE
- Cable Cross Section (mm²): 3x2,5

AND.PLS.7AIND020

- Electric Input: 400V AC 3N PE
- Cable Cross Section (mm²): 5x4

AND.PLS.7AIND030

- Electric Input: 400V AC 3N PE
- Cable Cross Section (mm²): 5x4



Kod Code	Ürün Adı Description	Ebatlar Dimension	Ağırlık Weight	Net Net
		a x b x c (mm)	(kg)	(m ³)
AND.PLS.7AKE010-P	Elektrikli Ocak 2 Rus Tipi Pleytli Electrical Cooker 2 Russian Type Plates	400x730x300	50	0.09
AND.PLS.7AKE020-P	Elektrikli Ocak 4 Rus Tipi Pleytli Electrical Cooker 4 Russian Type Plates	800x730x300	92	0.18
AND.PLS.7AKE030-P	Elektrikli Ocak 6 Rus Tipi Pleytli Electrical Cooker 6 Russian Type Plates	1200x730x300	125	0.26

TEKNİK ÖZELLİKLER

- 3 kademeli şalter.
- Kolay temizlenebilir ve hijyeniktir.
- Paslanmaz çelik gövde.

TECHNICAL SPECIFICATIONS

- 3 position switches.
- Easy to clean and hygienic.
- Stainless steel body.

AND.PLS.7AKE010-P

- Elektrik Girişi: 400V AC N PE
- Kablo Kesiti (mm²): 3x2,5

AND.PLS.7AKE010-P

- Electric Input: 400V AC N PE
- Cable Cross Section (mm²): 3x2,5

AND.PLS.7AKE020-P

- Elektrik Girişi: 400V AC 3N PE
- Kablo Kesiti (mm²): 5x2,5

AND.PLS.7AKE020-P

- Electric Input: 400V AC 3N PE
- Cable Cross Section (mm²): 5x2,5

AND.PLS.7AKE030-P

- Elektrik Girişi: 400V AC 3N PE
- Kablo Kesiti (mm²): 5x4

AND.PLS.7AKE030-P

- Electric Input: 400V AC 3N PE
- Cable Cross Section (mm²): 5x4



700 Plus Serisi
700 Plus Series

Elektrikli Set Altı Fırınlar
Electrical Undercounter Ovens

andora

CE



Kod Code	Ürün Adı Description	Ebatlar Dimension	Ağırlık Weight	Net Net	Güç Power
		a x b x c (mm)	(kg)	(m ³)	(kw)
AND.PLS.7AFRE01	Elektrikli Set Altı Fırın Electrical Undercounter Oven	800x620x550	70	0.27	9
AND.PLS.7AFRE02	Elektrikli Set Altı Fırın Electrical Undercounter Oven	1200x620x550	80	0.41	9
AND.PLS.7AFRE03	Elektrikli Set Altı Maxi Fırın Electrical Undercounter Maxi Oven	1200x620x550	98	0.41	15

TEKNİK ÖZELLİKLER

- 2 x Gn 2/1 tepsi kapasiteli paslanmaz çelik fırın iç haznesi.

AND.PLS.7AFRE01

- Elektrik Girişi: 400V AC 3N PE
- Kablo Kesiti (mm²): 5x2,5

AND.PLS.7AFRE02

- Elektrik Girişi: 400V AC 3N PE
- Kablo Kesiti (mm²): 5x2,5

AND.PLS.7AFRE03

- Elektrik Girişi: 400V AC 3N PE
- Kablo Kesiti (mm²): 5x2,5

TECHNICAL SPECIFICATIONS

- 2 x Gn 2/1 capacity, stainless steel internal room.

AND.PLS.7AFRE01

- Electric Input: 400V AC 3N PE
- Cable Cross Section (mm²): 5x2,5

AND.PLS.7AFRE02

- Electric Input: 400V AC 3N PE
- Cable Cross Section (mm²): 5x2,5

AND.PLS.7AFRE03

- Electric Input: 400V AC 3N PE
- Cable Cross Section (mm²): 5x2,5





Kod Code	Ürün Adı Description	Ebatlar Dimension	Ağırlık Weight	Net Net	Güç Power	Kapasite Capacity
		a x b x c (mm)	(kg)	(m ³)	(kw)	(lt)
AND.PLS.7AFE010	Elektrikli Fritöz Electrical Fryer	400x730x300	27	0.09	10.5	14
AND.PLS.7AFE020	Elektrikli Fritöz Electrical Fryer	800x730x300	44	0.18	21	14+14

TEKNİK ÖZELLİKLER

- Termostatik kontrol.
- Paslanmaz çelik sepetler.
- Hareketli ısıtıcılar kolay temizlik imkanı sağlar.
- Tahliye musluğu ile emniyetli yağ boşaltma.
- Limit termostat.
- Kolay temizlenebilir ve hijyeniktir.
- Paslanmaz çelik gövde.

TECHNICAL SPECIFICATIONS

- Thermostatic control.
- Stainless steel baskets.
- Moving heaters provide easy cleaning.
- Safe oil drainage from the bottom via valve.
- Safety thermostat for overheating protection.
- Easy to clean and hygienic.
- Stainless steel body.

**AND.PLS.7AFE010**

- Elektrik Girişi: 400V AC 3N PE
- Kablo Kesiti (mm²): 5x2,5

AND.PLS.7AFE010

- Electric Input: 400V AC 3N PE
- Cable Cross Section (mm²): 5x2,5

AND.PLS.7AFE020

- Elektrik Girişi: 400V AC 3N PE
- Kablo Kesiti (mm²): 5x2,5

AND.PLS.7AFE020

- Electric Input: 400V AC 3N PE
- Cable Cross Section (mm²): 5x2,5

700 Plus Serisi
700 Plus Series

Gazlı Fritözler
Gas Fryers

andora



Kod Code	Ürün Adı Description	Ebatlar Dimension	Ağırlık Weight	Net Net	Güç Power	Kapasite Capacity
		a x b x c (mm)	(kg)	(m ³)	(kw)	(lt)
AND.PLS.7AFG010-S	Gazlı Fritöz Gas Fryer	400x730x300	63	0.09	10	12
AND.PLS.7AFG020-S	Gazlı Fritöz Gas Fryer	800x730x300	113	0.18	20	12+12

TEKNİK ÖZELLİKLER

- Lpg ve Ng ile çalışabilme özelliği.
- Paslanmaz çelik sepetler.
- Magnet emniyet ventilli musluklar.
- Boşaltma borusu ile emniyetli yağ boşaltma.
- Limit termostat.
- Kolay temizlenebilir ve hijyeniktir.
- Paslanmaz çelik gövde.

TECHNICAL SPECIFICATIONS

- Lpg or Natural Gas.
- Stainless steel baskets.
- Magnet safety gas valve and thermocouple.
- Safe oil drainage from the bottom via valve.
- Safety thermostat for overheating protection.
- Easy to clean and hygienic.
- Stainless steel body.



AND.PLS.7AFG010-S

- Gaz Tüketim Değeri (ng): 1,84 m³/h
- Gaz Tüketim Değeri (lpg): 0,91 kg/h

AND.PLS.7AFG010-S

- Gas Consumption (ng): 1,84 m³/h
- Gas Consumption (lpg): 0,91 kg/h

AND.PLS.7AFG020-S

- Gaz Tüketim Değeri (ng): 3,68 m³/h
- Gaz Tüketim Değeri (lpg): 1,82 kg/h

AND.PLS.7AFG020-S

- Gas Consumption (ng): 3,68 m³/h
- Gas Consumption (lpg): 1,82 kg/h



Kod Code	Ürün Adı Description	Ebatlar Dimension	Ağırlık Weight	Net Net	Güç Power	Kapasite Capacity
		a x b x c (mm)	(kg)	(m ³)	(kw)	(lt)
AND.PLS.7AFG010	Gazlı Fritöz Dolaplı Gas Fryer With Cupboard	400x700x850	63	0.09	17.41	16
AND.PLS.7AFG020	Gazlı Fritöz Dolaplı Gas Fryer With Cupboard	800x730x850	113	0.18	34.82	16+16

TEKNİK ÖZELLİKLER

- Lpg ve Ng ile çalışabilme özelliği.
- Paslanmaz çelik sepetler.
- Magnet emniyet ventilli musluklar.
- Boşaltma borusu ile emniyetli yağ boşaltma.
- Limit termostat.
- Kolay temizlenebilir ve hijyeniktir.
- Paslanmaz çelik gövde.

TECHNICAL SPECIFICATIONS

- Lpg or Natural Gas.
- Stainless steel baskets.
- Magnet safety gas valve and thermocouple.
- Safe oil drainage from the bottom via valve.
- Safety thermostat for overheating protection.
- Easy to clean and hygienic.
- Stainless steel body.

AND.PLS.7AFG010

- Gaz Tüketim Değeri (ng): 1,84 m³/h
- Gaz Tüketim Değeri (lpg): 0,91 kg/h

AND.PLS.7AFG020

- Gaz Tüketim Değeri (ng): 3,68 m³/h
- Gaz Tüketim Değeri (lpg): 1,82 kg/h

AND.PLS.7AFG010

- Gas Consumption (ng): 1,84 m³/h
- Gas Consumption (lpg): 0,91 kg/h

AND.PLS.7AFG020

- Gas Consumption (ng): 3,68 m³/h
- Gas Consumption (lpg): 1,82 kg/h

700 Plus Serisi 700 Plus Series

Gazlı Izgaralar Gas Grills

andora



Kod Code	Ürün Adı Description	Ebatlar Dimension	Ağırlık Weight	Net Net	Güç Power
		a x b x c (mm)	(kg)	(m ³)	(kw)
AND.PLS.7AIG010	Gazlı Izgara Düz Pleyt Gas Grill Smooth Plate	400x730x300	51	0.09	8.67
AND.PLS.7AIG011	Gazlı Izgara Komple Oluklu Pleyt Gas Grill Ribbed Plate	400x730x300	51	0.09	8.67
AND.PLS.7AIG020	Gazlı Izgara Düz Pleyt Gas Grill Smooth Plate	800x730x300	90	0.18	17.34
AND.PLS.7AIG021	Gazlı Izgara Komple Oluklu Pleyt Gas Grill Ribbed Plate	800x730x300	90	0.18	17.34
AND.PLS.7AIG022	Gazlı Izgara Düz+Oluklu Pleyt Gas Grill Smooth+Ribbed Plate	800x730x300	90	0.18	17.34
AND.PLS.7AIG030	Gazlı Izgara Düz Pleyt Gas Grill Smooth Plate	1200x730x300	133	0.24	26
AND.PLS.7AIG031	Gazlı Izgara Komple Oluklu Pleyt Gas Grill Ribbed Plate	1200x730x300	133	0.24	26
AND.PLS.7AIG032	Gazlı Izgara Düz+Oluklu Pleyt Gas Grill Smooth+Ribbed Plate	1200x730x300	133	0.24	26

TEKNİK ÖZELLİKLER

- Lpg ve Ng ile çalışabilme özelliği.
- Magnet emniyet ventilli ve pilotlu musluklar.
- Tam modüllerde iki bölgeyi ısıtma.
- Her brülör için piezo çakmak ile kontrol.
- Çıkarılabilir yağ toplama haznesi.
- Paslanmaz çelik gövde.

TECHNICAL SPECIFICATIONS

- Lpg or Natural Gas.
- Magnet safety gas valve and pilot flame.
- Two separate heating zones.
- Piezo electric ignition system for each burner.
- Removable oil collection drawer.
- Stainless steel body.

AND.PLS.7AIG010 / AND.PLS.7AIG011

- Gaz Tüketim Değeri (ng): 0,91 m³/h
- Gaz Tüketim Değeri (lpg): 0,51 kg/h

AND.PLS.7AIG020 / AND.PLS.7AIG021 / AND.PLS.7AIG022

- Gaz Tüketim Değeri (ng): 1,83 m³/h
- Gaz Tüketim Değeri (lpg): 1,02 kg/h

AND.PLS.7AIG030 / AND.PLS.7AIG031 / AND.PLS.7AIG032

- Gaz Tüketim Değeri (ng): 2,74 m³/h
- Gaz Tüketim Değeri (lpg): 1,53 kg/h

AND.PLS.7AIG010 / AND.PLS.7AIG011

- Gas Consumption (ng): 0,91 m³/h
- Gas Consumption (lpg): 0,51 kg/h

AND.PLS.7AIG020 / AND.PLS.7AIG021 / AND.PLS.7AIG022

- Gas Consumption (ng): 1,83 m³/h
- Gas Consumption (lpg): 1,02 kg/h

AND.PLS.7AIG030 / AND.PLS.7AIG031 / AND.PLS.7AIG032

- Gas Consumption (ng): 2,74 m³/h
- Gas Consumption (lpg): 1,53 kg/h



Düz / Smooth



Düz + Oluklu / Smooth + Ribbed



Komple Oluklu / Complete Ribbed

CHROME PLATE

CE



Kod Code	Ürün Adı Description	Ebatlar Dimension	Ağırlık Weight	Net Net	Güç Power
		a x b x c (mm)	(kg)	(m ³)	(kw)
AND.PLS.7AIG010-K	Gazlı Izgara Düz Krom Pleyt Gas Grill Smooth Chrome Plate	400x730x300	51	0.09	8.67
AND.PLS.7AIG011-K	Gazlı Izgara Komple Oluklu Krom Pleyt Gas Grill Ribbed Chrome Plate	400x730x300	51	0.09	8.67
AND.PLS.7AIG020-K	Gazlı Izgara Düz Krom Pleyt Gas Grill Smooth Chrome Plate	800x730x300	90	0.18	17.34
AND.PLS.7AIG021-K	Gazlı Izgara Komple Oluklu Krom Pleyt Gas Grill Ribbed Chrome Plate	800x730x300	90	0.18	17.34
AND.PLS.7AIG022-K	Gazlı Izgara Düz+Oluklu Krom Pleyt Gas Grill Smooth+Ribbed Chrome Plate	800x730x300	90	0.18	17.34
AND.PLS.7AIG030-K	Gazlı Izgara Düz Krom Pleyt Gas Grill Smooth Chrome Plate	1200x730x300	133	0.24	26
AND.PLS.7AIG031-K	Gazlı Izgara Komple Oluklu Krom Pleyt Gas Grill Ribbed Chrome Plate	1200x730x300	133	0.24	26
AND.PLS.7AIG032-K	Gazlı Izgara Düz+Oluklu Krom Pleyt Gas Grill Smooth+Ribbed Chrome Plate	1200x730x300	133	0.24	26

TEKNİK ÖZELLİKLER

- Lpg ve Ng ile çalışabilme özelliği.
- Magnet emniyet ventilli ve pilotlu musluklar.
- Tam modüllerde iki bölgeyi ısıtma.
- Her brülör için piezo çakmak ile kontrol.
- Çıkarılabilir yağ toplama haznesi.
- Paslanmaz çelik gövde.

TECHNICAL SPECIFICATIONS

- Lpg or Natural Gas.
- Magnet safety gas valve and pilot flame.
- Two separate heating zones.
- Piezo electric ignition system for each burner.
- Removable oil collection drawer.
- Stainless steel body.



AND.PLS.7AIG010-K / AND.PLS.7AIG011-K

- Gaz Tüketim Değeri (ng): 0,75 m³/h
- Gaz Tüketim Değeri (lpg): 0,52 kg/h

AND.PLS.7AIG020-K / AND.PLS.7AIG021-K /
AND.PLS.7AIG022-K

- Gaz Tüketim Değeri (ng): 1,50 m³/h
- Gaz Tüketim Değeri (lpg): 1,04 kg/h

AND.PLS.7AIG030-K / AND.PLS.7AIG031-K /
AND.PLS.7AIG032-K

- Gaz Tüketim Değeri (ng): 2,15 m³/h
- Gaz Tüketim Değeri (lpg): 1,56 kg/h

AND.PLS.7AIG010-K / AND.PLS.7AIG011-K

- Gas Consumption (ng): 0,75 m³/h
- Gas Consumption (lpg): 0,52 kg/h

AND.PLS.7AIG020-K / AND.PLS.7AIG021-K /
AND.PLS.7AIG022-K

- Gas Consumption (ng): 1,50 m³/h
- Gas Consumption (lpg): 1,04 kg/h

AND.PLS.7AIG030-K / AND.PLS.7AIG031-K /
AND.PLS.7AIG032-K

- Gas Consumption (ng): 2,15 m³/h
- Gas Consumption (lpg): 1,56 kg/h

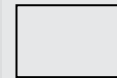

Düz / Smooth



Düz + Oluklu / Smooth + Ribbed



Komple Oluklu / Complete Ribbed

700 Plus Serisi 700 Plus Series

Elektrikli Izgaralar Electrical Grills

andora



Kod Code	Ürün Adı Description	Ebatlar Dimension a x b x c (mm)	Ağırlık Weight (kg)	Net Net (m ³)	Güç Power (kw)
AND.PLS.7AIE010	Elektrikli Izgara Düz Pleyt Electrical Grill Smooth Plate	400x730x300	55	0.09	4.2
AND.PLS.7AIE011	Elektrikli Izgara Komple Oluklu Pleyt Electrical Grill Ribbed Plate	400x730x300	55	0.09	4.2
AND.PLS.7AIE020	Elektrikli Izgara Düz Pleyt Electrical Grill Smooth Plate	800x730x300	97	0.18	8.4
AND.PLS.7AIE021	Elektrikli Izgara Komple Oluklu Pleyt Electrical Grill Ribbed Plate	800x730x300	97	0.18	8.4
AND.PLS.7AIE022	Elektrikli Izgara Düz+Oluklu Pleyt Electrical Grill Smooth+Ribbed Plate	800x730x300	97	0.18	8.4
AND.PLS.7AIE030	Elektrikli Izgara-Düz Pleyt Electrical Grill Smooth Plate	1200x730x300	138	0.24	12.6
AND.PLS.7AIE031	Elektrikli Izgara Komple Oluklu Pleyt Electrical Grill Ribbed Plate	1200x730x300	138	0.24	12.6
AND.PLS.7AIE032	Elektrikli Izgara Düz+Oluklu Pleyt Electrical Grill Smooth+Ribbed Plate	1200x730x300	138	0.24	12.6

TEKNİK ÖZELLİKLER

- Termostatik kumanda.
- Tam modüllerde iki bölgeyi ısıtma.
- Çıkarılabilir yağ toplama haznesi
- Kolay temizlenebilir ve hijyeniktir.
- Paslanmaz çelik gövde.

TECHNICAL SPECIFICATIONS

- Thermostatic control.
- Two separate heating zones.
- Removable oil collection drawer.
- Easy to clean and hygienic.
- Stainless steel body.

AND.PLS.7AIE010 / AND.PLS.7AIE011

- Elektrik Girişi: 400V AC 3N PE
- Kablo Kesiti (mm²): 5x2,5

AND.PLS.7AIE020 / AND.PLS.7AIE021 / AND.PLS.7AIE022

- Elektrik Girişi: 400V AC 3N PE
- Kablo Kesiti (mm²): 5x2,5

AND.PLS.7AIE030 / AND.PLS.7AIE031 / AND.PLS.7AIE032

- Elektrik Girişi: 400V AC 3N PE
- Kablo Kesiti (mm²): 5x2,5

AND.PLS.7AIE010 / AND.PLS.7AIE011

- Electric Input: 400V AC 3N PE
- Cable Cross Section (mm²): 5x2,5

AND.PLS.7AIE020 / AND.PLS.7AIE021 / AND.PLS.7AIE022

- Electric Input: 400V AC 3N PE
- Cable Cross Section (mm²): 5x2,5

AND.PLS.7AIE030 / AND.PLS.7AIE031 / AND.PLS.7AIE032

- Electric Input: 400V AC 3N PE
- Cable Cross Section (mm²): 5x2,5

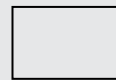

Düz / Smooth



Düz + Oluklu / Smooth + Ribbed



Komple Oluklu / Complete Ribbed



Kod Code	Ürün Adı Description	Ebatlar Dimension	Ağırlık Weight	Net Net	Güç Power
		a x b x c (mm)	(kg)	(m ³)	(kw)
AND.PLS.7AIE010-K	Elektrikli Izgara Düz Krom Pleyt Electrical Grill Smooth Chrome Plate	400x730x300	55	0.09	4.2
AND.PLS.7AIE011-K	Elektrikli Izgara Komple Oluklu Krom Pleyt Electrical Grill Ribbed Chrome Plate	400x730x300	55	0.09	4.2
AND.PLS.7AIE020-K	Elektrikli Izgara Düz Krom Pleyt Electrical Grill Smooth Chrome Plate	800x730x300	97	0.18	8.4
AND.PLS.7AIE021-K	Elektrikli Izgara Komple Oluklu Krom Pleyt Electrical Grill Ribbed Chrome Plate	800x730x300	97	0.18	8.4
AND.PLS.7AIE022-K	Elektrikli Izgara Düz+Oluklu Krom Pleyt Electrical Grill Smooth+Ribbed Chrome Plate	800x730x300	97	0.18	8.4
AND.PLS.7AIE030-K	Elektrikli Izgara Düz Krom Pleyt Electrical Grill Smooth Chrome Plate	1200x730x300	138	0.24	12.6
AND.PLS.7AIE031-K	Elektrikli Izgara Komple Oluklu Krom Pleyt Electrical Grill Ribbed Chrome Plate	1200x730x300	138	0.24	12.6
AND.PLS.7AIE032-K	Elektrikli Izgara Düz+Oluklu Krom Pleyt Electrical Grill Smooth+Ribbed Chrome Plate	1200x730x300	138	0.24	12.6

TEKNİK ÖZELLİKLER

- Termostatik kumanda.
- Tam modüllerde iki bölgeyi ısıtma.
- Çıkarılabilir yağ toplama haznesi
- Kolay temizlenebilir ve hijyeniktir.
- Paslanmaz çelik gövde.

TECHNICAL SPECIFICATIONS

- Thermostatic control.
- Two separate heating zones.
- Removable oil collection drawer.
- Easy to clean and hygienic.
- Stainless steel body.



Düz / Smooth



Düz + Oluklu / Smooth + Ribbed



Komple Oluklu / Complete Ribbed

AND.PLS.7AIE010-K / AND.PLS.7AIE011-K

- Elektrik Girişi: 400V AC 3N PE
- Kablo Kesiti (mm²): 5x2,5

AND.PLS.7AIE020-K / AND.PLS.7AIE021-K /
AND.PLS.7AIE022-K

- Elektrik Girişi: 400V AC 3N PE
- Kablo Kesiti (mm²): 5x2,5

AND.PLS.7AIE030-K / AND.PLS.7AIE031-K /
AND.PLS.7AIE032-K

- Elektrik Girişi: 400V AC 3N PE
- Kablo Kesiti (mm²): 5x2,5

AND.PLS.7AIE010-K / AND.PLS.7AIE011-K

- Electric Input: 400V AC 3N PE
- Cable Cross Section (mm²): 5x2,5

AND.PLS.7AIE020-K / AND.PLS.7AIE021-K /
AND.PLS.7AIE022-K

- Electric Input: 400V AC 3N PE
- Cable Cross Section (mm²): 5x2,5

AND.PLS.7AIE030-K / AND.PLS.7AIE031-K /
AND.PLS.7AIE032-K

- Electric Input: 400V AC 3N PE
- Cable Cross Section (mm²): 5x2,5

700 Plus Serisi 700 Plus Series

Gazlı Sulu Izgaralar Gas Vapor Grills

andora



Kod Code	Ürün Adı Description	Ebatlar Dimension	Ağırlık Weight	Net Net	Güç Power
		a x b x c (mm)	(kg)	(m ³)	(kw)
AND.PLS.7ALG010-S	Gazlı Sulu Izgara Gas Vapor Grill	400x730x300	57	0.09	5.80
AND.PLS.7ALG020-S	Gazlı Sulu Izgara Gas Vapor Grill	800x730x300	98	0.18	11.60
AND.PLS.7ALG030-S	Gazlı Sulu Izgara Gas Vapor Grill	1200x730x300	143	0.26	17.40

TEKNİK ÖZELLİKLER

- Buharlaştırma kabini sayesinde daha verimli pişirme.
- Lpg ve Ng ile çalışabilme özelliği.
- Magnet emniyet ventilli ve pilotlu musluklar.
- Tam modüllerde iki bölgeyi ısıtma.
- Her brülör için piezo çakmak ile kontrol.
- Pik döküm ızgara.
- Kolay temizlenebilir ve hijyeniktir.
- Paslanmaz çelik gövde.

TECHNICAL SPECIFICATIONS

- Steamer cabinet provides fertile cooking.
- Lpg or Natural Gas.
- Magnet safety gas valve and pilot flame.
- Two separate heating zones.
- Piezo electric ignition system for each burner.
- Cast iron plate.
- Easy to clean and hygienic.
- Stainless steel body.



AND.PLS.7ALG010-S

- Gaz Tüketim Değeri (ng): 0,61 m³/h
- Gaz Tüketim Değeri (lpg): 0,60 kg/h

AND.PLS.7ALG020-S

- Gaz Tüketim Değeri (ng): 1,23 m³/h
- Gaz Tüketim Değeri (lpg): 1,20 kg/h

AND.PLS.7ALG030-S

- Gaz Tüketim Değeri (ng): 1,84 m³/h
- Gaz Tüketim Değeri (lpg): 1,80 kg/h

AND.PLS.7ALG010-S

- Gas Consumption (ng): 0,61 m³/h
- Gas Consumption (lpg): 0,60 kg/h

AND.PLS.7ALG020-S

- Gas Consumption (ng): 1,23 m³/h
- Gas Consumption (lpg): 1,20 kg/h

AND.PLS.7ALG030-S

- Gas Consumption (ng): 1,84 m³/h
- Gas Consumption (lpg): 1,80 kg/h



Kod Code	Ürün Adı Description	Ebatlar Dimension	Ağırlık Weight	Net Net	Güç Power
		a x b x c (mm)	(kg)	(m ³)	(kw)
AND.PLS.7ALE010	Elektrikli Sulu Izgara Electrical Vapor Grill	400x730x300	31	0.09	3.75
AND.PLS.7ALE020	Elektrikli Sulu Izgara Electrical Vapor Grill	800x730x300	45	0.18	8.75
AND.PLS.7ALE030	Elektrikli Sulu Izgara Electrical Vapor Grill	1200x730x300	66	0.26	13.75

TEKNİK ÖZELLİKLER

- Buharlaştırma kabini sayesinde daha verimli pişirme.
- Kolay kaldırılabilir rezistanslar sayesinde kolay temizlik imkanı.
- Daha kısa sürede daha az enerji ile pişirme imkanı.
- Kolay temizlenebilir ve hijyeniktir.
- Paslanmaz çelik gövde.

TECHNICAL SPECIFICATIONS

- Steamer cabinet provides fertile cooking.
- Easy tilting heaters provide easy cleaning.
- Faster cooking with low energy.
- Easy to clean and hygienic.
- Stainless steel body.



AND.PLS.7ALE010

- Elektrik Girişi: 400V AC 3N PE
- Kablo Kesiti (mm²): 5x2,5

AND.PLS.7ALE020

- Elektrik Girişi: 400V AC 3N PE
- Kablo Kesiti (mm²): 5x2,5

AND.PLS.7ALE030

- Elektrik Girişi: 400V AC 3N PE
- Kablo Kesiti (mm²): 5x2,5

AND.PLS.7ALE010

- Electric Input: 400V AC 3N PE
- Cable Cross Section (mm²): 5x2,5

AND.PLS.7ALE020

- Electric Input: 400V AC 3N PE
- Cable Cross Section (mm²): 5x2,5

AND.PLS.7ALE030

- Electric Input: 400V AC 3N PE
- Cable Cross Section (mm²): 5x2,5

700 Plus Serisi 700 Plus Series

Gazlı Lavataşlı Izgaralar Gas Lavastone Grills

andora



Kod Code	Ürün Adı Description	Ebatlar Dimension	Ağırlık Weight	Net Net	Güç Power
		a x b x c (mm)	(kg)	(m ³)	(kw)
AND.PLS.7ALG010	Gazlı Lavataşlı Izgara Gas Lavastone Grill	400x730x300	55	0.09	8.67
AND.PLS.7ALG020	Gazlı Lavataşlı Izgara Gas Lavastone Grill	800x730x300	105	0.18	17.34
AND.PLS.7ALG030	Gazlı Lavataşlı Izgara Gas Lavastone Grill	1200x730x300	143	0.24	26

TEKNİK ÖZELLİKLER

- Lpg ve Ng ile çalışabilme özelliği.
- Magnet emniyet ventilli ve pilotlu musluklar.
- Tam modüllerde iki bölgeyi ısıtma.
- Her brülör için piezo çakmak ile kontrol.
- Çıkarılabilir yağ toplama haznesi.
- Kolay temizlenebilir ve hijyeniktir.
- Paslanmaz çelik gövde.

TECHNICAL SPECIFICATIONS

- Lpg or Natural Gas.
- Safety gas valve and pilot flame.
- Two separate heating zones.
- Piezo electric ignition system for each burner.
- Removable oil collection drawer.
- Easy to clean and hygienic.
- Stainless steel body.



AND.PLS.7ALG010

- Gaz Tüketim Değeri (ng): 0,91 m³/h
- Gaz Tüketim Değeri (lpg): 0,51 kg/h

AND.PLS.7ALG020

- Gaz Tüketim Değeri (ng): 1,82 m³/h
- Gaz Tüketim Değeri (lpg): 1,02 kg/h

AND.PLS.7ALG030

- Gaz Tüketim Değeri (ng): 2,73 m³/h
- Gaz Tüketim Değeri (lpg): 1,54 kg/h

AND.PLS.7ALG010

- Gas Consumption (ng): 0,91 m³/h
- Gas Consumption (lpg): 0,51 kg/h

AND.PLS.7ALG020

- Gas Consumption (ng): 1,82 m³/h
- Gas Consumption (lpg): 1,02 kg/h

AND.PLS.7ALG030

- Gas Consumption (ng): 2,73 m³/h
- Gas Consumption (lpg): 1,54 kg/h



Kod Code	Ürün Adı Description	Ebatlar Dimension	Ağırlık Weight	Net Net	Güç Power
		a x b x c (mm)	(kg)	(m ³)	(kw)
AND.PLS.AS-1	Amerikan Gazlı Izgara American Gas Grill	800x920x1100	55	0.09	24.2
AND.PLS.AS-2	Amerikan Gazlı Izgara American Gas Grill	1160x920x1100	105	0.18	36.2

TEKNİK ÖZELLİKLER

- Ağır kullanım için uygun yüksek pişirme verimliliği.
- Lpg ve Ng ile çalışabilme özelliği.
- Magnet emniyet ventilli ve pilotlu musluklar.
- Tam modüllerde çok bölgeli ısıtma.
- Pik döküm brülör şapkası.
- Kolay temizlenebilir ve hijyeniktir.
- Paslanmaz çelik gövde.

TECHNICAL SPECIFICATIONS

- High cooking efficiency, suitable for heavy use.
- Ability to work with LPG and Ng
- Magnet safety valve and piloted taps.
- Multi-zone heating in full modules.
- Cast iron burner cap.
- Easy to clean and hygienic.
- Stainless steel body.



AND.PLS.AS-1

- Gaz Tüketim Değeri (ng): 0,91 m³/h
- Gaz Tüketim Değeri (lpg): 0,51 kg/h

AND.PLS.AS-1

- Gas Consumption (ng): 0,91 m³/h
- Gas Consumption (lpg): 0,51 kg/h

AND. PLS.AS-2

- Gaz Tüketim Değeri (ng): 1,82 m³/h
- Gaz Tüketim Değeri (lpg): 1,02 kg/h

AND. PLS.AS-2

- Gas Consumption (ng): 1,82 m³/h
- Gas Consumption (lpg): 1,02 kg/h

700 Plus Serisi
700 Plus Series

Elektrikli Benmariler
Electrical Bainmaries

andora



Kod Code	Ürün Adı Description	Ebatlar Dimension	Ağırlık Weight	Net Net	Güç Power
		a x b x c (mm)	(kg)	(m ³)	(kw)
AND.PLS.7ASE010	Elektrikli Benmari Electrical Bainmarie	400x730x300	24	0.09	1.5
AND.PLS.7ASE020	Elektrikli Benmari Electrical Bainmarie	800x730x300	40	0.18	3

TEKNİK ÖZELLİKLER

- Termostatik kumanda.
- Tahliye musluğu.
- Su alma musluğu.
- Kolay temizlenebilir ve hijyeniktir.
- Paslanmaz çelik gövde.

AND.PLS.7ASE010

- Kapasite; 1 adet 1/1 Gn

AND.PLS.7ASE020

- Kapasite; 2 adet 1/1 Gn.

TECHNICAL SPECIFICATIONS

- Thermostatic control.
- Drainage valve.
- Water inlet valve.
- Easy to clean and hygienic.
- Stainless steel body.

AND.PLS.7ASE010

- Capacity; 1 piece 1/1 Gn.

AND.PLS.7ASE020

- Capacity; 2 pieces 1/1 Gn.

AND.PLS.7ASE010

- Elektrik Girişi: 230V AC N PE
- Kablo Kesiti (mm²): 3x2,5

AND.PLS.7ASE020

- Elektrik Girişi: 230V AC N PE
- Kablo Kesiti (mm²): 3x2,5

AND.PLS.7ASE010

- Electric Input: 230V AC N PE
- Cable Cross Section (mm²): 3x2,5

AND.PLS.7ASE020

- Electric Input: 230V AC N PE
- Cable Cross Section (mm²): 3x2,5



Standart üretimimizde küvet bulunmamaktadır.
Standard product does not have containers.



Kod Code	Ürün Adı Description	Ebatlar Dimension	Ağırlık Weight	Net Net	Güç Power	Kapasite Capacity
		a x b x c (mm)	(kg)	(m ³)	(kw)	(lt)
AND.PLS.7AME010	Elektrikli Makarna Haşlama Electrical Pasta Cooker	400x730x300	36	0.09	10.5	10.5

TEKNİK ÖZELLİKLER

- Termostatik kontrol.
- Paslanmaz çelik sepetler.
- Su doldurma musluğu.
- Tahliye musluğu ile su boşaltma.
- Taşan su tahliye sistemi.
- Kolay temizlenebilir ve hijyeniktir.
- Paslanmaz çelik gövde.

TECHNICAL SPECIFICATIONS

- Thermostatic control.
- Stainless steel baskets.
- Water filling tap.
- Discharge valve.
- Overflow drainage system.
- Easy to clean and hygienic.
- Stainless steel body.

AND.PLS.7AME010

- Elektrik Girişi: 400V AC 3N PE
- Kablo Kesiti (mm²): 5x2,5

AND.PLS.7AME010

- Electric Input: 400V AC 3N PE
- Cable Cross Section (mm²): 5x2,5



Kod Code	Ürün Adı Description	Ebatlar Dimension	Ağırlık Weight	Net Net	Güç Power	Kapasite Capacity
		a x b x c (mm)	(kg)	(m ³)	(kw)	(gn/mm)
AND.PLS.7ADE010	Patates Dinlendirme Ünitesi Chips Scuttle Unit	400x730x300	21	0.09	0.65	1/1-150

TEKNİK ÖZELLİKLER

- Kızartılmış patateslerin sıcak bekletilmesinde ve yağların süzülmesinde kullanılır.
- Infrared seramik ısıtıcı.
- Havuzda kızartma yağının süzülmesi için maksimum verim sağlayan özel form.
- Kolay temizlenebilir ve hijyeniktir.
- Paslanmaz çelik gövde.

TECHNICAL SPECIFICATIONS

- Operates in order to keep fries warm and drain oil.
- Infrared ceramic heater.
- Special form on the container, provides maximum efficiency in order to drain oil.
- Easy to clean and hygienic.
- Stainless steel body.

AND.PLS.7ADE010

- Elektrik Girişi: 230V AC N PE
- Kablo Kesiti (mm²): 3x1,5

AND.PLS.7ADE010

- Electric Input: 230V AC N PE
- Cable Cross Section (mm²): 3x1,5

700 Plus Serisi
700 Plus Series

Ara Tezgahlar
Worktops

andora

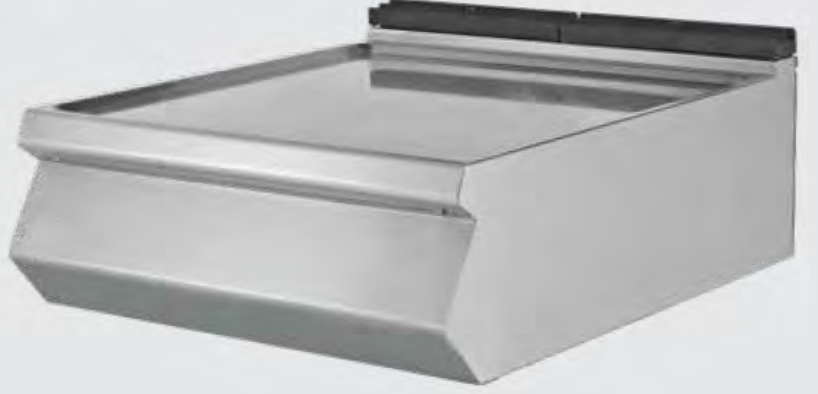

Kod Code	Ürün Adı Description	Ebatlar Dimension a x b x c (mm)	Ağırlık Weight (kg)	Net Net (m ³)
AND.PLS.7ATN010	Ara Tezgah 1/2 Modül Worktop 1/2 Module	400x730x300	18	0.09
AND.PLS.7ATN020	Ara Tezgah 1/1 Modül Worktop 1/1 Module	800x730x300	26	0.18

TEKNİK ÖZELLİKLER

- Kolay temizlenebilir ve hijyeniktir.
- Tezgahlar 70 seri cihazların arasında kullanılacak uygun ölçülerdedir.

TECHNICAL SPECIFICATIONS

- Easy to clean and hygienic.
- Worktops are suitable to use between each kind of 70's serie equipments.



Kod Code	Ürün Adı Description	Ebatlar Dimension	Ağırlık Weight	Net Net
		a x b x c (mm)	(kg)	(m ³)
AND.PLS.7ATS010	Set Altı Tezgah 1 Kapaklı Undercounter Cabinet with 1 Door	400x620x550	17	0.09
AND.PLS.7ATS020	Set Altı Tezgah 2 Kapaklı Undercounter Cabinet with 2 Doors	800x620x550	28	0.18
AND.PLS.7ATS030	Set Altı Tezgah 3 Kapaklı Undercounter Cabinet with 3 Doors	1200x620x550	37	0.26

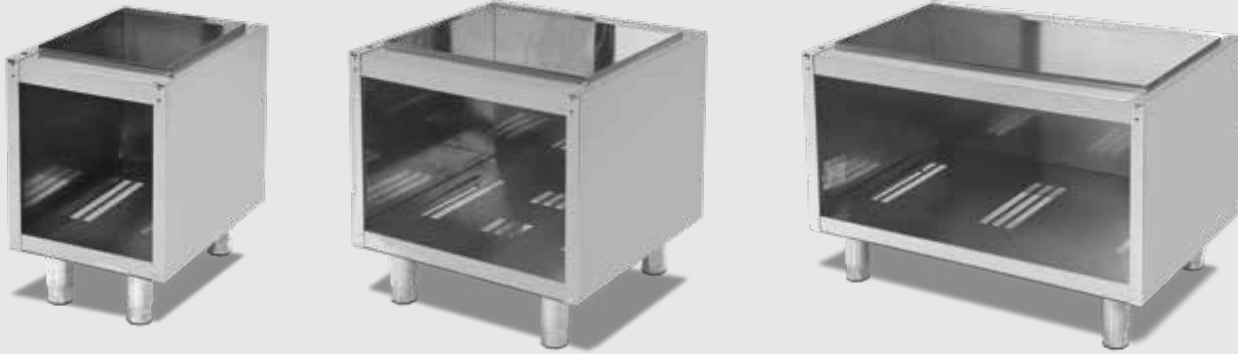

Kod Code	Ürün Adı Description	Ebatlar Dimension	Ağırlık Weight	Net Net
		a x b x c (mm)	(kg)	(m ³)
AND.PLS.7ATS010-K	Set Altı Tezgah Kapaksız Undercounter Cabinet without Door	400x620x550	14	0.09
AND.PLS.7ATS020-K	Set Altı Tezgah Kapaksız Undercounter Cabinet without Door	800x620x550	16	0.18
AND.PLS.7ATS030-K	Set Altı Tezgah Kapaksız Undercounter Cabinet without Door	1200x620x550	18	0.26

TEKNİK ÖZELLİKLER

- Tezgahlar 70 seri cihazların altına kullanılabilecek uygun modüler ölçülerdedir.
- Kolay temizlenebilir ve hijyeniktir.
- Paslanmaz çelik gövde.

TECHNICAL SPECIFICATIONS

- Under-Set Counters are suitable to use under each kind of 70's serie equipments.
- Easy to clean and hygienic.
- Stainless steel body.

700 Plus Serisi
700 Plus Series

Devrilir Tavalar
Tilting Pans

andora



Kod Code	Ürün Adı Description	Ebatlar Dimension	Ağırlık Weight	Net Net	Güç Power	Kapasite Capacity
		a x b x c (mm)	(kg)	(m ³)	(kw)	(lt)
AND.PLS.ADTG.50	Gazlı Devrilir Tava Gas Tilting Pan	800x730x850	116	0.70	11.20	50
AND.PLS.ADTE.50	Elektrikli Devrilir Tava Electrical Tilting Pan	800x730x850	120	0.70	9	50

TEKNİK ÖZELLİKLER

- Manuel kaldırma mekanizması.
- Karşı ağırlıklı kapak.
- Kolay temizlenebilir ve hijyeniktir.
- Paslanmaz çelik gövde.

AND.PLS.ADTG.50

- Lpg ve Ng ile çalışabilme özelliği.
- Magnet emniyet ventilli termokulp ve termostat.

AND.PLS.ADTE.50

- Limit termostat.

AND.PLS.ADTG.50

- Gaz Tüketim Değeri (ng): 1,18 m³/h
- Gaz Tüketim Değeri (lpg): 0,68 kg/h

AND.PLS.ADTE.50

- Elektrik Girişi: 400V AC 3N PE
- Kablo Kesiti (mm²): 5x2,5

TECHNICAL SPECIFICATIONS

- Manuel lift system.
- Counterweighted hinged lid.
- Easy to clean and hygienic.
- Stainless steel body.

AND.PLS.ADTG.50

- Lpg or Natural Gas.
- Safety gas valve thermocouple and thermostat.

AND.PLS.ADTE.50

- Limit thermostat.

AND.PLS.ADTG.50

- Gas Consumption (ng): 1,18 m³/h
- Gas Consumption (lpg): 0,68 kg/h

AND.PLS.ADTE.50

- Electric Input: 400V AC 3N PE
- Cable Cross Section (mm²): 5x2,5



Kod Code	Ürün Adı Description	Ebatlar Dimension	Ağırlık Weight	Net Net	Güç Power	Kapasite Capacity
		a x b x c (mm)	(kg)	(m ³)	(kw)	(lt)
AND.PLS.AKTG.70	Gazlı Kaynatma Tenceresi Gas Boiling Pan	800x730x850	105	0.70	11.20	70
AND.PLS.AKTE.70	Elektrikli Kaynatma Tenceresi Electrical Boiling Pan	800x730x850	98	0.70	12	70

TEKNİK ÖZELLİKLER

- Aşırı basınç valfi ve manometre.
- Su doldurma musluğu.
- Tahliye musluğu.
- Karşı ağırlıklı kapak.
- Çift cidarlı ceket.
- Kolay temizlenebilir ve hijyeniktir.
- Paslanmaz çelik gövde.

AND.PLS.AKTG.70

- Lpg ve Ng ile çalışabilme özelliği.
- Magnet emniyet ventilli termokupl ve termostat.

AND.PLS.AKTE.70

- Limit termostat.

TECHNICAL SPECIFICATIONS

- Over pressure safety valve and manometer.
- Water inlet valve.
- Drainage valve.
- Counterweighted hinged lid.
- Double jacket pan.
- Easy to clean and hygienic.
- Stainless steel body.

AND.PLS.AKTG.70

- Lpg or Natural Gas.
- Safety gas valve thermocouple and thermostat.

AND.PLS.AKTE.70

- Limit thermostat.

AND.PLS.AKTG.70

- Gaz Tüketim Değeri (ng): 1,18 m³/h
- Gaz Tüketim Değeri (lpg): 0,98 kg/h

AND.PLS.AKTE.70

- Elektrik Girişi: 400V AC 3N PE
- Kablo Kesiti (mm²): 5x4

AND.PLS.AKTG.70

- Gas Consumption (ng): 1,18 m³/h
- Gas Consumption (lpg): 0,98 kg/h

AND.PLS.AKTE.70

- Electric Input: 400V AC 3N PE
- Cable Cross Section (mm²): 5x4

700 Plus Serisi
700 Plus Series

Cantilever Hat
Cantilever Line

andora



Kod Code	Ürün Adı Description	Ebatlar Dimension
		a x b x c (mm)

AND.PLS.7ACTV240 Cantilever Hat
Cantilever Line 2400x1370x550

Kod Code	Ürün Adı Description	Ebatlar Dimension
		a x b x c (mm)

AND.PLS.7ACTV280 Cantilever Hat
Cantilever Line 2800x1370x550

Kod Code	Ürün Adı Description	Ebatlar Dimension
		a x b x c (mm)

AND.PLS.7ACTV320 Cantilever Hat
Cantilever Line 3200x1370x550

Kod Code	Ürün Adı Description	Ebatlar Dimension
		a x b x c (mm)

AND.PLS.7ACTV360 Cantilever Hat
Cantilever Line 3600x1370x550

Kod Code	Ürün Adı Description	Ebatlar Dimension
		a x b x c (mm)

AND.PLS.7ACTV400 Cantilever Hat
Cantilever Line 4000x1370x550

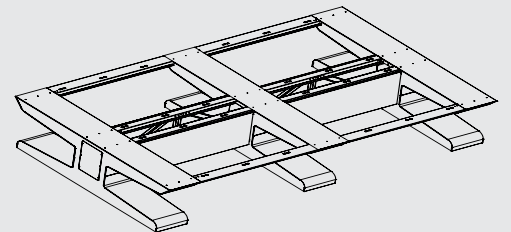
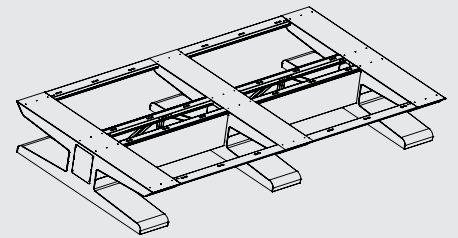
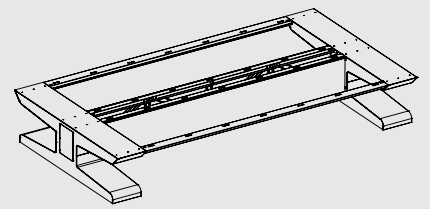
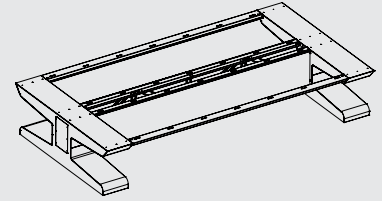
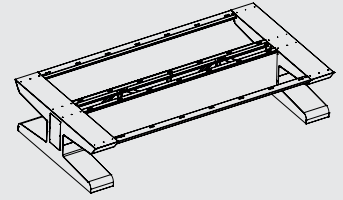

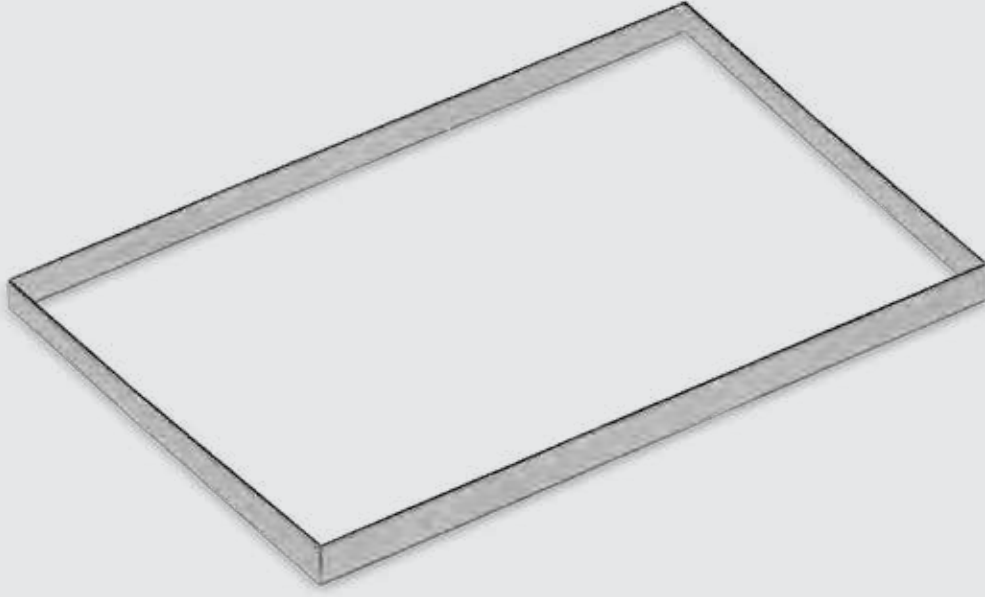

Kod Code	Ürün Adı Description	Ebatlar Dimension a x b x c (mm)
AND.PLS.7ASBP240	Paslanmaz Alt Baza 240 cm Stainless Steel Frame 240 cm	2400x1370x550
AND.PLS.7ASBP280	Paslanmaz Alt Baza 280 cm Stainless Steel Frame 280 cm	2800x1370x550
AND.PLS.7ASBP320	Paslanmaz Alt Baza 320 cm Stainless Steel Frame 320 cm	3200x1370x550
AND.PLS.7ASBP360	Paslanmaz Alt Baza 360 cm Stainless Steel Frame 360 cm	3600x1370x550
AND.PLS.7ASBP400	Paslanmaz Alt Baza 400 cm Stainless Steel Frame 400 cm	4000x1370x550



900 Plus Serisi
900 Plus Series

***PLUS**



andora

andora

900 PLUS SERİSİ

Gazlı Kuzine Fırınlı
Yer Ocakları
Gazlı Ocaklar
Gazlı Wok Ocaklar
Gazlı Set Altı Fırınlar
Elektrikli Ocaklar (Kare Pleytli)
Elektrikli İndüksiyon Ocaklar
Elektrikli Ocaklar (Rus Tipi Pleyt)
Elektrikli Set Altı Fırınlar
Patates Dinlendirme Üniteleri
Asansörlü Hızlı Pişirme Fritözleri (Yağ Filtreli)
Elektrikli Fritözler
Gazlı Fritözler
Gazlı Izgaralar
Gazlı Izgaralar (Krom Pleyt)
Elektrikli Izgaralar
Elektrikli Izgaralar (Krom Pleyt)
Gazlı Sulu Izgaralar
Gazlı Lavataşlı Izgaralar
Elektrikli Makarna Haşlama - Patates Dinlendirme Üniteleri
Elektrikli Benmariler
Ara Tezgahlar
Set Altı Tezgahlar
Gazlı Devrilir Tavalar
Elektrikli Devrilir Tavalar
Gazlı Kaynatma Tencereleri (İndirekt)
Elektrikli Kaynatma Tencereleri (İndirekt)
Cantilever Hat
Paslanmaz Alt Bazalar

900 PLUS SERIES

Gas Range with Oven
Floor Cookers
Gas Cookers
Gas Wok Cookers
Undercounter Gas Ovens
Electrical Cookers (with Square Plates)
Electrical Induction Cookers
Electrical Cookers (Russian Type Plate)
Electrical Undercounter Ovens
Chips Scuttle Units
with Lift Fast Cooking Fryers (with Oil Filter)
Electrical Fryers
Gas Fryers
Gas Grills
Gas Grills (Chrome Plate)
Electrical Grills
Electrical Grills (Chrome Plate)
Gas Vapor Grills
Gas Lavastone Grills
Electrical Pasta Cooker - Chips Scuttle Units
Electrical Bainmaries
Worktops
Undercounter Cabinets
Gas Tilting Pans
Electrical Tilting Pans
Gas Boiling Pans (Indirect)
Electrical Boiling Pans (Indirect)
Cantilever Line
Stainless Steel Bases



Kod Code	Ürün Adı Description	Ebatlar Dimension	Ağırlık Weight	Net Net	Güç Power
		a x b x c (mm)	(kg)	(m ³)	(kw)
AND.9AKG.021	Gazlı Kuzine Fırınlı 4 Brülörlü Gas Range with Oven 4 Burners	1000x1000x850	155	0.85	40

TEKNİK ÖZELLİKLER

- Lpg ve Ng ile çalışabilme özelliği.
- 2xGN 2/1 tepsi kapasiteli paslanmaz çelik fırın haznesi.
- Magnet emniyet ventilli musluklar.
- Darbelere karşı dayanıklı üst döküm.
- Kolay temizlenebilir ve hijyeniktir.
- Paslanmaz çelik gövde.

TECHNICAL SPECIFICATIONS

- Lpg or Natural Gas.
- 2xGN 2/1 capacity, stainless steel internal chamber.
- Magnet safety valves.
- Heavy duty top cast iron.
- Easy to clean and hygienic.
- Stainless steel body.



AND.9AKG.021

- Gaz Tüketim Değeri (ng): 4,23 m³/h
- Gaz Tüketim Değeri (lpg): 3,13 kg/h

AND.9AKG.021

- Gas Consumption (ng): 4,23 m³/h
- Gas Consumption (lpg): 3,13 kg/h

900 Plus Serisi 900 Plus Series

Yer Ocakları Floor Cookers

andora



Kod Code	Ürün Adı Description	Ebatlar Dimension	Ağırlık Weight	Net Net	Güç Power
		a x b x c (mm)	(kg)	(m ³)	(kw)
AND.AYRG.60	Gazlı Yer Ocağı Floor Type Gas Cooker	600x800x500	60	0.24	27.24
AND.AYRG.80	4 Yanırlı Gazlı Yer Ocağı 4 Rings Floor Type Gas Cooker	700x915x560	80	0.35	31.25

TEKNİK ÖZELLİKLER

- Lpg ve Ng ile çalışabilme özelliği.
- Magnet emniyet ventilli musluklar.
- Darbelere karşı dayanıklı üst döküm.
- Kolay temizlenebilir ve hijyeniktir.
- Paslanmaz çelik gövde.

TECHNICAL SPECIFICATIONS

- Lpg or Natural Gas.
- Magnet safety valves.
- Heavy duty top cast iron.
- Easy to clean and hygienic.
- Stainless steel body.

AND.AYRG.60

- Gaz Tüketim Değeri (ng): 2,88 m³/h
- Gaz Tüketim Değeri (lpg): 1,42 kg/h

AND.AYRG.60

- Gas Consumption (ng): 2,88 m³/h
- Gas Consumption (lpg): 1,42 kg/h

AND.AYRG.80

- Gaz Tüketim Değeri (ng): 3,30 m³/h
- Gaz Tüketim Değeri (lpg): 2,48 kg/h

AND.AYRG.80

- Gas Consumption (ng): 3,30 m³/h
- Gas Consumption (lpg): 2,48 kg/h



4 Yanırlı Yüksek Güç Brülör
4 Rings High Power Burner



Kod Code	Ürün Adı Description	Ebatlar Dimension	Ağırlık Weight	Net Net	Güç Power
		a x b x c (mm)	(kg)	(m ³)	(kw)
AND.AYRE.60	Elektrikli Yer Ocağı Floor Type Electrical Cooker	600x800x500	60	0.24	4

TEKNİK ÖZELLİKLER

- 6 Kademeli şalter.
- Elektrik Girişi: 400V AC 3N PE
- Kablo Kesiti (mm²): 3x2,5

TECHNICAL SPECIFICATIONS

- 6 stage switch.
- Electric Input: 400V AC 3N PE
- Cable Cross Section (mm²): 3x2,5



Kod Code	Ürün Adı Description	Ebatlar Dimension	Ağırlık Weight	Net Net	Güç Power
		a x b x c (mm)	(kg)	(m ³)	(kw)
AND.PLS.9AKG020-0	Gazlı Ocak Kapalı Döküm Gas Cooker Solid Top	800x900x285	94	0.21	11.20

TEKNİK ÖZELLİKLER

- Lpg ve Ng ile çalışabilme özelliği.
- 16 mm üst döküm tabla.
- Magnet emniyet ventilli musluklar.
- Paslanmaz çelik gövde.
- Piezzo çakmak ile kontrol.
- Kolay temizlenebilir ve hijyeniktir.

TECHNICAL SPECIFICATIONS

- Lpg or Natural Gas.
- Magnet safety gas valve .
- 16 mm top cast plate.
- Stainless steel body.
- Piezo electric ignition system.
- Easy to clean and hygienic.

**AND.PLS.9AKG020-0**

- Gaz Tüketim Değeri (ng): 1,18 m³/h
- Gaz Tüketim Değeri (lpg): 0,68 kg/h

AND.PLS.9AKG020-0

- Gas Consumption (ng): 1,18 m³/h
- Gas Consumption (lpg): 0,68 kg/h



Kod Code	Ürün Adı Description	Ebatlar Dimension	Ağırlık Weight	Net Net	Güç Power
		a x b x c (mm)	(kg)	(m ³)	(kw)
AND.PLS.9AYRG80	Gazlı Ocak 4 Yanırlı Gas Cooker 4 Rings	800x900x300	76	0.21	31.25

TEKNİK ÖZELLİKLER

- Lpg ve Ng ile çalışabilme özelliği.
- Magnet emniyet ventilli musluklar.
- Darbelere karşı dayanıklı üst döküm.
- Paslanmaz çelik gövde.
- 4 Yanırlı Brulör.
- Kolay temizlenebilir ve hijyeniktir.
- Paslanmaz çelik gövde.

TECHNICAL SPECIFICATIONS

- Lpg or Natural Gas.
- Magnet safety valves.
- Heavy duty top cast iron.
- Stainless steel body.
- 4 Ring high power burner.
- Easy to clean and hygienic.
- Stainless steel body.

**AND.PLS.9AYRG80**

- Gaz Tüketim Değeri (ng): 3,30 m³/h
- Gaz Tüketim Değeri (lpg): 2,25 kg/h

AND.PLS.9AYRG80

- Gas Consumption (ng): 3,30 m³/h
- Gas Consumption (lpg): 2,25 kg/h

4 Yanırlı Yüksek Güç Brulör
4 Rings High Power Burner

900 Plus Serisi 900 Plus Series

Gazlı Ocaklar Gas Cookers

andora



Kod Code	Ürün Adı Description	Ebatlar Dimension	Ağırlık Weight	Net Net	Güç Power
		a x b x c (mm)	(kg)	(m ³)	(kw)
AND.PLS.9AKG010	Gazlı Ocak 2 Brülörlü Gas Cooker 2 Burners	400x900x300	44	0.11	17.48
AND.PLS.9AKG020	Gazlı Ocak 4 Brülörlü Gas Cooker 4 Burners	800x900x300	82	0.22	34.97
AND.PLS.9AKG030	Gazlı Ocak 6 Brülörlü Gas Cooker 6 Burners	1200x900x300	127	0.32	52.45

TEKNİK ÖZELLİKLER

- Lpg ve Ng ile çalışabilme özelliği.
- Magnet emniyet ventilli musluklar.
- Darbelere karşı dayanıklı üst döküm.
- Paslanmaz çelik gövde.
- Kolay temizlenebilir ve hijyeniktir.

TECHNICAL SPECIFICATIONS

- Lpg or Natural Gas
- Magnet safety valves.
- Heavy duty top cast iron.
- Stainless steel body.
- Easy to clean and hygienic.

AND.PLS.9AKG010

- Gaz Tüketim Değeri (ng): 1,85 m³/h
- Gaz Tüketim Değeri (lpg): 1,37 kg/h

AND.PLS.9AKG020

- Gaz Tüketim Değeri (ng): 3,70 m³/h
- Gaz Tüketim Değeri (lpg): 2,75 kg/h

AND.PLS.9AKG030

- Gaz Tüketim Değeri (ng): 5,55 m³/h
- Gaz Tüketim Değeri (lpg): 4,13 kg/h

AND.PLS.9AKG010

- Gas Consumption (ng): 1,85 m³/h
- Gas Consumption (lpg): 1,37 kg/h

AND.PLS.9AKG020

- Gas Consumption (ng): 3,70 m³/h
- Gas Consumption (lpg): 2,75 kg/h

AND.PLS.9AKG030

- Gas Consumption (ng): 5,55 m³/h
- Gas Consumption (lpg): 4,13 kg/h





Kod Code	Ürün Adı Description	Ebatlar Dimension	Ağırlık Weight	Net Net	Güç Power
		a x b x c (mm)	(kg)	(m ³)	(kw)
AND.PLS.9AWK010	Gazlı Wok Ocağı 1 Brülörlü Gas Wok Cooker 1 Burner	400x900x300	45	0.11	18
AND.PLS.9AWK020	Gazlı Wok Ocağı 2 Brülörlü Gas Wok Cooker 2 Burners	800x900x300	84	0.22	36
AND.PLS.9AWK030	Gazlı Wok Ocağı 3 Brülörlü Gas Wok Cooker 3 Burners	1200x900x300	110	0.32	54

TEKNİK ÖZELLİKLER

- Lpg ve Ng ile çalışabilme özelliği.
- Magnet emniyet ventilli musluklar.
- Darbelere karşı dayanıklı üst döküm.
- Her brülör için piezzo çakmak ile kontrol.
- Yüksek güçlü pik döküm brülörler yüksek sıcaklık sağlamaktadır.
- Kolay temizlenebilir ve hijyeniktir.
- Paslanmaz çelik gövde.

TECHNICAL SPECIFICATIONS

- Lpg or Natural Gas.
- Magnet safety gas valve and thermocouple.
- Heavy duty top cast iron.
- Piezo electric ignition system for each burner.
- High power cast iron burners provide the high temperature that is aimed to be reached.
- Easy to clean and hygienic.
- Stainless steel body.



AND.PLS.9AWK010

- Gaz Tüketim Değeri (ng): 1,90 m³/h
- Gaz Tüketim Değeri (lpg): 1,05 kg/h

AND.PLS.9AWK020

- Gaz Tüketim Değeri (ng): 3,8 m³/h
- Gaz Tüketim Değeri (lpg): 2,10 kg/h

AND.PLS.9AWK030

- Gaz Tüketim Değeri (ng): 5,60 m³/h
- Gaz Tüketim Değeri (lpg): 3,15 kg/h

AND.PLS.9AWK010

- Gas Consumption (ng): 1,90 m³/h
- Gas Consumption (lpg): 1,05 kg/h

AND.PLS.9AWK020

- Gas Consumption (ng): 3,8 m³/h
- Gas Consumption (lpg): 2,10 kg/h

AND.PLS.9AWK030

- Gas Consumption (ng): 5,60 m³/h
- Gas Consumption (lpg): 3,15 kg/h

900 Plus Serisi 900 Plus Series

Gazlı Set Altı Fırınlar Undercounter Gas Ovens

andora

CE



Kod Code	Ürün Adı Description	Ebatlar Dimension	Ağırlık Weight	Net Net	Güç Power
		a x b x c (mm)	(kg)	(m ³)	(kw)
AND.PLS.9AFRG01	Gazlı Set Altı Fırın Undercounter Gas Oven	800x790x550	78	0.32	6.46
AND.PLS.9AFRG02	Gazlı Set Altı Fırın Undercounter Gas Oven	1200x790x550	93	0.52	6.46
AND.PLS.9AFRG03	Gazlı Set Altı Maxi Fırın Gas Undercounter Maxi Oven	1200x790x550	113	0.52	12.93

TEKNİK ÖZELLİKLER

- Lpg ve Ng ile çalışabilme özelliği.
- 2xGn 2/1 tepsi kapasiteli paslanmaz çelik fırın iç haznesi.
- Termostatik ayarlı fırın gaz ventilli.

AND.PLS.9AFRG01

- Gaz Tüketim Değeri (ng): 0,68 m³/h
- Gaz Tüketim Değeri (lpg): 0,43 kg/h

AND.PLS.9AFRG02

- Gaz Tüketim Değeri (ng): 0,68 m³/h
- Gaz Tüketim Değeri (lpg): 0,43 kg/h

AND.PLS.9AFRG03

- Gaz Tüketim Değeri (ng): 1,36 m³/h
- Gaz Tüketim Değeri (lpg): 0,87 kg/h

TECHNICAL SPECIFICATIONS

- Lpg or Natural Gas
- 2xGn 2/1 capacity, stainless steel internal room.
- For oven: temperature control with thermostatic gas valve.

AND.PLS.9AFRG01

- Gas Consumption (ng): 0,68 m³/h
- Gas Consumption (lpg): 0,43 kg/h

AND.PLS.9AFRG02

- Gas Consumption (ng): 0,68 m³/h
- Gas Consumption (lpg): 0,43 kg/h

AND.PLS.9AFRG03

- Gas Consumption (ng): 1,36 m³/h
- Gas Consumption (lpg): 0,87 kg/h





Kod Code	Ürün Adı Description	Ebatlar Dimension	Ağırlık Weight	Net Net	Güç Power
		a x b x c (mm)	(kg)	(m ³)	(kw)
AND.PLS.9AKE010	Elektrikli Ocak 2 Kare Pleytli Electrical Cooker 2 Square Plates	400x900x300	45	0.11	8
AND.PLS.9AKE020	Elektrikli Ocak 4 Kare Pleytli Electrical Cooker 4 Square Plates	800x900x300	81	0.22	16
AND.PLS.9AKE030	Elektrikli Ocak 6 Kare Pleytli Electrical Cooker 6 Square Plates	1200x900x300	121	0.32	24

TEKNİK ÖZELLİKLER

- 6 kademeli şalter.
- Kolay temizlenebilir ve hijyeniktir.
- Paslanmaz çelik gövde.

TECHNICAL SPECIFICATIONS

- 6 position switch.
- Easy to clean and hygienic.
- Stainless steel body.



AND.PLS.9AKE010

- Elektrik Girişi: 400V AC 3N PE
- Kablo Kesiti (mm²): 5x2,5

AND.PLS.9AKE010

- Electric Input: 400V AC 3N PE
- Cable Cross Section (mm²): 5x2,5

AND.PLS.9AKE020

- Elektrik Girişi: 400V AC 3N PE
- Kablo Kesiti (mm²): 5x4

AND.PLS.9AKE020

- Electric Input: 400V AC 3N PE
- Cable Cross Section (mm²): 5x4

AND.PLS.9AKE030

- Elektrik Girişi: 400V AC 3N PE
- Kablo Kesiti (mm²): 5x4

AND.PLS.9AKE030

- Electric Input: 400V AC 3N PE
- Cable Cross Section (mm²): 5x4

900 Plus Serisi
900 Plus Series

Elektrikli İndüksiyon Ocaklar
Electrical Induction Cookers

andora



Kod Code	Ürün Adı Description	Ebatlar Dimension	Ağırlık Weight	Net Net	Güç Power
		a x b x c (mm)	(kg)	(m ³)	(kw)
AND.PLS.9AIND010	Elektrikli İndüksiyon Ocak 2'li Electrical Induction Cooker 2	400x900x300	34	0.11	7
AND.PLS.9AIND020	Elektrikli İndüksiyon Ocak 4'lü Electrical Induction Cooker 4	800x900x300	56	0.22	14
AND.PLS.9AIND030	Elektrikli İndüksiyon Ocak 6'lı Electrical Induction Cooker 6	1200x900x300	90	0.32	21

TEKNİK ÖZELLİKLER

- Cam pişirme yüzeyi.
- Kolay temizlenebilir ve hijyeniktir.
- Paslanmaz çelik gövde.

TECHNICAL SPECIFICATIONS

- Glass cooking surface.
- Easy to clean and hygienic.
- Stainless steel body.

AND.PLS.9AIND010

- Elektrik Girişi: 230V AC N PE
- Kablo Kesiti (mm²): 3x4

AND.PLS.9AIND010

- Electric Input: 230V AC N PE
- Cable Cross Section (mm²): 3x4

AND.PLS.9AIND020

- Elektrik Girişi: 400V AC 3N PE
- Kablo Kesiti (mm²): 5x4

AND.PLS.9AIND020

- Electric Input: 400V AC 3N PE
- Cable Cross Section (mm²): 5x4

AND.PLS.9AIND030

- Elektrik Girişi: 400V AC 3N PE
- Kablo Kesiti (mm²): 5x4

AND.PLS.9AIND030

- Electric Input: 400V AC 3N PE
- Cable Cross Section (mm²): 5x4



Kod Code	Ürün Adı Description	Ebatlar Dimension	Ağırlık Weight	Net Net	Güç Power
		a x b x c (mm)	(kg)	(m ³)	(kw)
AND.PLS.9AKE010-P	Elektrikli Ocak 2 Rus Tipi Pleytli Electrical Cooker 2 Russian Type Plates	400x900x300	80	0.011	8
AND.PLS.9AKE020-P	Elektrikli Ocak 4 Rus Tipi Pleytli Electrical Cooker 4 Russian Type Plates	800x900x300	122	0.22	16
AND.PLS.9AKE030-P	Elektrikli Ocak 6 Rus Tipi Pleytli Electrical Cooker 6 Russian Type Plates	1200x900x300	155	0.32	24

TEKNİK ÖZELLİKLER

- 3 kademeli şalter.
- Kolay temizlenebilir ve hijyeniktir.
- Paslanmaz çelik gövde.

TECHNICAL SPECIFICATIONS

- 3 position switches.
- Easy to clean and hygienic.
- Stainless steel body.

AND.PLS.9AKE010-P

- Elektrik Girişi: 400V AC N PE
- Kablo Kesiti (mm²): 3x2,5

AND.PLS.9AKE010-P

- Electric Input: 400V AC N PE
- Cable Cross Section (mm²): 3x2,5

AND.PLS.9AKE020-P

- Elektrik Girişi: 400V AC 3N PE
- Kablo Kesiti (mm²): 5x2,5

AND.PLS.9AKE020-P

- Electric Input: 400V AC 3N PE
- Cable Cross Section (mm²): 5x2,5

AND.PLS.9AKE030-P

- Elektrik Girişi: 400V AC 3N PE
- Kablo Kesiti (mm²): 5x4

AND.PLS.9AKE030-P

- Electric Input: 400V AC 3N PE
- Cable Cross Section (mm²): 5x4



900 Plus Serisi
900 Plus Series

Elektrikli Set Altı Fırınlar
Electrical Undercounter Ovens

andora

CE



Kod Code	Ürün Adı Description	Ebatlar Dimension	Ağırlık Weight	Net Net	Güç Power
		a x b x c (mm)	(kg)	(m ³)	(kw)
AND.PLS.9AFRE01	Elektrikli Set Altı Fırın Electrical Undercounter Oven	800x790x550	72	0.32	9
AND.PLS.9AFRE02	Elektrikli Set Altı Fırın Electrical Undercounter Oven	1200x790x550	80	0.52	9
AND.PLS.9AFRE03	Elektrikli Set Altı Maxi Fırın Electrical Undercounter Maxi Oven	1200x790x550	105	0.52	15

TEKNİK ÖZELLİKLER

- 2x2/1 Gn tepsi kapasiteli paslanmaz çelik fırın iç haznesi.

TECHNICAL SPECIFICATIONS

- 2x2/1 Gn capacity, stainless steel internal room.

AND.PLS.9AFRE01

- Elektrik Girişi: 400V AC 3N PE
- Kablo Kesiti (mm²): 5x2,5

AND.PLS.9AFRE01

- Electric Input: 400V AC 3N PE
- Cable Cross Section (mm²): 5x2,5

AND.PLS.9AFRE02

- Elektrik Girişi: 400V AC 3N PE
- Kablo Kesiti (mm²): 5x2,5

AND.PLS.9AFRE02

- Electric Input: 400V AC 3N PE
- Cable Cross Section (mm²): 5x2,5

AND.PLS.9AFRE03

- Elektrik Girişi: 400V AC 3N PE
- Kablo Kesiti (mm²): 5x2,5

AND.PLS.9AFRE03

- Electric Input: 400V AC 3N PE
- Cable Cross Section (mm²): 5x2,5



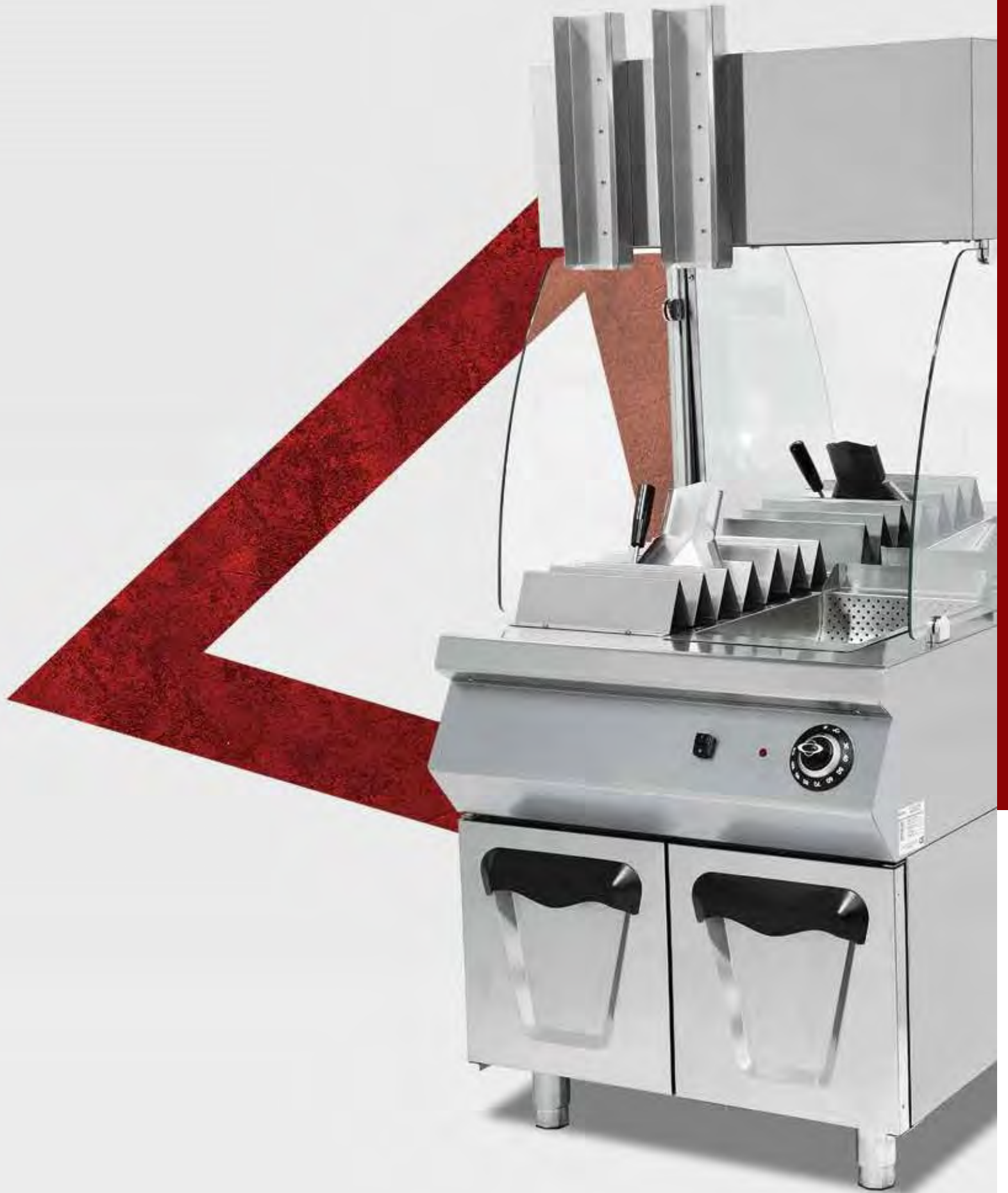

900 Plus Serisi
900 Plus Series

Patates Dinlendirme Üniteleri
Chips Scuttle Units

andora

CE



Kod Code	Ürün Adı Description	Ebatlar Dimension	Ağırlık Weight	Net Net	Güç Power
		a x b x c (mm)	(kg)	(m ³)	(kw)
AND.PLS.ADE.9618	Patates Dinlendirme Ünitesi Chips Scuttle Unit	800x900x1830	157	1.32	2.8

TEKNİK ÖZELLİKLER

- Kızartılmış patateslerin sıcak bekletilmesinde ve yağların süzülmesinde kullanılır.
- Paslanmaz çelik gövde.
- Havuzda kızartma yağının süzülmesi için maksimum verim sağlayan özel form.
- Kolay temizlenebilir ve hijyeniktir.

AND.PLS.ADE.9618

- Elektrik Girişi: 400V AC 3N PE
- Kablo Kesiti (mm²): 3x2,5

TECHNICAL SPECIFICATIONS

- Using to keep french fries warm and drains oil.
- Stainless steel body.
- The special shape of the container provides maximum efficiency for draining extra oil.
- Easy to clean and hygienic.

AND.PLS.ADE.9618

- Electric Input: 400V AC 3N PE
- Cable Cross Section (mm²): 3x2,5





Touch Screen



Kod Code	Ürün Adı Description	Ebatlar Dimension	Ağırlık Weight	Net Net	Güç Power	Kapasite Capacity
		a x b x c (mm)	(kg)	(m ³)	(kw)	(lt)
AND.PLS.AODFE.010	Asansörlü Hızlı Pişirme Fritözü Yağ Filtreli with Lift Fast Cooking Fryer with Oil Filter	400x900x850	79	0.11	30	25
AND.PLS.AODFE.020	Asansörlü Hızlı Pişirme Fritözü Yağ Filtreli with Lift Fast Cooking Fryer with Oil Filter	800x900x850	139	0.22	60	25+25

TEKNİK ÖZELLİKLER

- Paslanmaz çelik sepetler.
- Limit termostat.
- Kolay temizlenebilir ve hijyeniktir.
- Filtrelenmiş yağı devirdaim yapma sistemi.
- 10 Program hafızalı.
- 4.3 inch dijital ekran.
- Farklı ürünler için sıcaklık ve zaman ayarlama.
- Pişirme bitiminde sesli uyarı sistemi.
- Her sepet için ayrı kontrol sistemi.
- Otomatik dolumlu yağ filtresi.
- Paslanmaz çelik gövde.

TECHNICAL SPECIFICATIONS

- Stainless steel baskets.
- Limit thermostat.
- Easy to clean and hygienic.
- Recirculation system filters the oil.
- 10 Programs memory.
- 4.3 inch digital screen.
- Setting temperature and time for different products.
- Voice warning system at the end of cooking.
- Separate control system for basket.
- Automatic filling oil filter.
- Stainless steel body.

**AND.PLS.AODFE.010**

- Elektrik Girişi: 400V AC 3N PE
- Kablo Kesiti (mm²): 5x4

AND.PLS.AODFE.020

- Elektrik Girişi: 400V AC 3N PE
- Kablo Kesiti (mm²): 5x4

AND.PLS.AODFE.010

- Elektrik Girişi: 400V AC 3N PE
- Kablo Cross Section (mm²): 5x4

AND.PLS.AODFE.020

- Elektrik Girişi: 400V AC 3N PE
- Kablo Cross Section (mm²): 5x4

900 Plus Serisi
900 Plus Series

Elektrikli Fritözler
Electrical Fryers

andora



Kod Code	Ürün Adı Description	Ebatlar Dimension	Ağırlık Weight	Net Net	Güç Power	Kapasite Capacity
		a x b x c (mm)	(kg)	(m ³)	(kw)	(lt)
AND.PLS.9AFE010	Elektrikli Fritöz Electrical Fryer	400x900x850	50	0.30	18	24
AND.PLS.9AFE020	Elektrikli Fritöz Electrical Fryer	800x900x850	88	0.61	36	24+24

TEKNİK ÖZELLİKLER

- Termostatik kumanda.
- Paslanmaz çelik sepetler.
- Hareketli ısıtıcılar kolay temizlik imkanı sağlar.
- Paslanmaz çelik gövde.
- Boşaltma borusu ile emniyetli yağ boşaltma.
- Limit termostat.
- Kolay temizlenebilir ve hijyeniktir.

TECHNICAL SPECIFICATIONS

- Thermostatic control.
- Stainless steel baskets.
- Moving heaters provide easy cleaning.
- Stainless steel body.
- Safe oil drainage from the bottom via valve.
- Safety thermostat for overheating protection.
- Easy to clean and hygienic.

AND.PLS.9AFE010

- Elektrik Girişi: 400V AC 3N PE
- Kablo Kesiti (mm²): 5x2,5

AND.PLS.9AFE020

- Elektrik Girişi: 400V AC 3N PE
- Kablo Kesiti (mm²): 5x4

AND.PLS.9AFE010

- Electric Input: 400V AC 3N PE
- Cable Cross Section (mm²): 5x2,5

AND.PLS.9AFE020

- Electric Input: 400V AC 3N PE
- Cable Cross Section (mm²): 5x4



Kod Code	Ürün Adı Description	Ebatlar Dimension	Ağırlık Weight	Net Net	Güç Power	Kapasite Capacity
		a x b x c (mm)	(kg)	(m ³)	(kw)	(lt)
AND.PLS.9AFG010	Gazlı Fritöz Gas Fryer	400x900x850	68	0.31	17.41	24
AND.PLS.9AFG020	Gazlı Fritöz Gas Fryer	800x900x850	118	0.62	34.82	24+24

TEKNİK ÖZELLİKLER

- Lpg ve Ng ile çalışabilme özelliği.
- Paslanmaz çelik sepetler.
- Magnet emniyet ventilli musluklar.
- Boşaltma borusu ile emniyetli yağ boşaltma.
- Limit termostat.
- Kolay temizlenebilir ve hijyeniktir.
- Paslanmaz çelik gövde.

AND.PLS.9AFG010

- Gaz Tüketim Değeri (ng): 1,84 m³/h
- Gaz Tüketim Değeri (lpg): 0,91 kg/h

AND.PLS.9AFG020

- Gaz Tüketim Değeri (ng): 3,68 m³/h
- Gaz Tüketim Değeri (lpg): 1,82 kg/h

TECHNICAL SPECIFICATIONS

- Lpg or Natural Gas.
- Stainless steel baskets.
- Magnet safety gas valve and thermocouple.
- Safe oil drainage from the bottom via valve.
- Safety thermostat for overheating protection.
- Easy to clean and hygienic.
- Stainless steel body.

AND.PLS.9AFG010

- Gas Consumption (ng): 1,84 m³/h
- Gas Consumption (lpg): 0,91 kg/h

AND.PLS.9AFG020

- Gas Consumption (ng): 3,68 m³/h
- Gas Consumption (lpg): 1,82 kg/h

900 Plus Serisi 900 Plus Series

Gazlı Izgaralar Gas Grills

andora



Kod Code	Ürün Adı Description	Ebatlar Dimension	Ağırlık Weight	Net Net	Güç Power
		a x b x c (mm)	(kg)	(m ³)	(kw)
AND.PLS.9AIG010	Gazlı Izgara Düz Pleyt Gas Grill Smooth Plate	400x900x300	62	0.11	10.32
AND.PLS.9AIG011	Gazlı Izgara Komple Oluklu Pleyt Gas Grill Ribbed Plate	400x900x300	62	0.11	10.32
AND.PLS.9AIG020	Gazlı Izgara Düz Pleyt Gas Grill Smooth Plate	800x900x300	106	0.22	20.64
AND.PLS.9AIG021	Gazlı Izgara Komple Oluklu Pleyt Gas Grill Ribbed Plate	800x900x300	106	0.22	20.64
AND.PLS.9AIG022	Gazlı Izgara Düz+Oluklu Pleyt Gas Grill Smooth+Ribbed Plate	800x900x300	106	0.22	20.64
AND.PLS.9AIG030	Gazlı Izgara Düz Pleyt Gas Grill Smooth Plate	1200x900x300	106	0.33	31.02
AND.PLS.9AIG031	Gazlı Izgara Komple Oluklu Pleyt Gas Grill Ribbed Plate	1200x900x300	106	0.33	31.02
AND.PLS.9AIG032	Gazlı Izgara Düz+Oluklu Pleyt Gas Grill Smooth+Ribbed Plate	1200x900x300	106	0.33	31.02

TEKNİK ÖZELLİKLER

- Lpg ve Ng ile çalışabilme özelliği.
- Magnet emniyet ventilli ve pilotlu musluklar.
- Tam modüllerde iki bölgeyi ısıtma.
- Paslanmaz çelik gövde.
- Her brülör için piezzo çakmak ile kontrol.
- Çıkarılabilir yağ toplama haznesi

TECHNICAL SPECIFICATIONS

- Lpg or Natural Gas.
- Magnet safety gas valve and pilot flame.
- Two separate heating zones.
- Stainless steel body.
- Piezo electric ignition system for each burner.
- Removable oil collecting drawer.

AND.PLS.9AIG010 / AND.PLS.9AIG011

- Gaz Tüketim Değeri (ng): 1,09 m³/h
- Gaz Tüketim Değeri (lpg): 0,77 kg/h

AND.PLS.9AIG020 / AND.PLS.9AIG021 / AND.PLS.9AIG022

- Gaz Tüketim Değeri (ng): 2,18 m³/h
- Gaz Tüketim Değeri (lpg): 1,55 kg/h

AND.PLS.9AIG030 / AND.PLS.9AIG031 / AND.PLS.9AIG032

- Gaz Tüketim Değeri (ng): 3,28 m³/h
- Gaz Tüketim Değeri (lpg): 2,33 kg/h

AND.PLS.9AIG010 / AND.PLS.9AIG011

- Gas Consumption (ng): 1,09 m³/h
- Gas Consumption (lpg): 0,77 kg/h

AND.PLS.9AIG020 / AND.PLS.9AIG021 / AND.PLS.9AIG022

- Gas Consumption (ng): 2,18 m³/h
- Gas Consumption (lpg): 1,55 kg/h

AND.PLS.9AIG030 / AND.PLS.9AIG031 / AND.PLS.9AIG032

- Gas Consumption (ng): 3,28 m³/h
- Gas Consumption (lpg): 2,33 kg/h

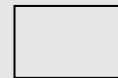

Düz / Smooth



Düz + Oluklu / Smooth + Ribbed



Komple Oluklu / Complete Ribbed

CHROME PLATE



Kod Code	Ürün Adı Description	Ebatlar Dimension	Ağırlık Weight	Net Net	Güç Power
		a x b x c (mm)	(kg)	(m ³)	(kw)
AND.PLS.9AIG010-K	Gazlı Izgara Düz-Krom Pleyt Gas Grill Smooth-Chrome Plate	400x900x300	62	0.11	10.32
AND.PLS.9AIG011-K	Gazlı Izgara Komple Oluklu Krom Pleyt Gas Grill Ribbed Chrome Plate	400x900x300	62	0.11	10.32
AND.PLS.9AIG020-K	Gazlı Izgara-Düz Krom Pleyt Gas Grill Smooth-Chrome Plate	800x900x300	106	0.22	20.64
AND.PLS.9AIG021-K	Gazlı Izgara Komple Oluklu Krom Pleyt Gas Grill Ribbed Chrome Plate	800x900x300	106	0.22	20.64
AND.PLS.9AIG022-K	Gazlı Izgara Düz+Oluklu Krom Pleyt Gas Grill Smooth+Ribbed Chrome Plate	800x900x300	106	0.22	20.64
AND.PLS.9AIG030-K	Gazlı Izgara Düz-Krom Pleyt Gas Grill Smooth-Chrome Plate	1200x900x300	106	0.33	31.02
AND.PLS.9AIG031-K	Gazlı Izgara Komple Oluklu Krom Pleyt Gas Grill Ribbed Chrome Plate	1200x900x300	106	0.33	31.02
AND.PLS.9AIG032-K	Gazlı Izgara Düz+Oluklu Krom Pleyt Gas Grill Smooth+Ribbed Chrome Plate	1200x900x300	106	0.33	31.02

TEKNİK ÖZELLİKLER

- Lpg ve Ng ile çalışabilme özelliği.
- Magnet emniyet ventilli ve pilotlu musluklar.
- Tam modüllerde iki bölgeyi ısıtma.
- Paslanmaz çelik gövde.
- Her brülör için piezzo çakmak ile kontrol.
- Çıkarılabilir yağ toplama haznesi

TECHNICAL SPECIFICATIONS

- Lpg or Natural Gas.
- Magnet safety gas valve and pilot flame.
- Two separate heating zones.
- Stainless steel body.
- Piezo electric ignition system for each burner.
- Removable oil collecting drawer.

AND.PLS.9AIG010-K / AND.PLS.9AIG011-K

- Gaz Tüketim Değeri (ng): 1,09 m³/h
- Gaz Tüketim Değeri (lpg): 0,77 kg/h

AND.PLS.9AIG020-K / AND.PLS.9AIG021-K / AND.PLS.9AIG022-K

- Gaz Tüketim Değeri (ng): 2,18 m³/h
- Gaz Tüketim Değeri (lpg): 1,55 kg/h

AND.PLS.9AIG030-K / AND.PLS.9AIG031-K / AND.PLS.9AIG032-K

- Gaz Tüketim Değeri (ng): 3,28 m³/h
- Gaz Tüketim Değeri (lpg): 2,33 kg/h

AND.PLS.9AIG010-K / AND.PLS.9AIG011-K

- Gas Consumption (ng): 1,09 m³/h
- Gas Consumption (lpg): 0,77 kg/h

AND.PLS.9AIG020-K / AND.PLS.9AIG021-K / AND.PLS.9AIG022-K

- Gas Consumption (ng): 2,18 m³/h
- Gas Consumption (lpg): 1,55 kg/h

AND.PLS.9AIG030-K / AND.PLS.9AIG031-K / AND.PLS.9AIG032-K

- Gas Consumption (ng): 3,28 m³/h
- Gas Consumption (lpg): 2,33 kg/h

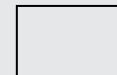

Düz / Smooth



Düz + Oluklu / Smooth + Ribbed



Komple Oluklu / Complete Ribbed

900 Plus Serisi 900 Plus Series

Elektrikli Izgaralar Electrical Grills

andora



Kod Code	Ürün Adı Description	Ebatlar Dimension	Ağırlık Weight	Net Net	Güç Power
		a x b x c (mm)	(kg)	(m ²)	(kw)
AND.PLS.9AIE010	Elektrikli Izgara Düz Pleyt Electrical Grill Smooth Plate	400x900x300	62	0.11	6
AND.PLS.9AIE011	Elektrikli Izgara Komple Oluklu Pleyt Electrical Grill Ribbed Plate	400x900x300	62	0.11	6
AND.PLS.9AIE020	Elektrikli Izgara Düz Pleyt Electrical Grill Smooth Plate	800x900x300	115	0.22	12
AND.PLS.9AIE021	Elektrikli Izgara Komple Oluklu Pleyt Electrical Grill Ribbed Plate	800x900x300	115	0.22	12
AND.PLS.9AIE022	Elektrikli Izgara Düz+Oluklu Pleyt Electrical Grill Smooth+Ribbed Plate	800x900x300	115	0.22	12
AND.PLS.9AIE030	Elektrikli Izgara Düz Pleyt Electrical Grill Smooth Plate	1200x900x300	115	0.33	18
AND.PLS.9AIE031	Elektrikli Izgara Komple Oluklu Pleyt Electrical Grill Ribbed Plate	1200x900x300	115	0.33	18
AND.PLS.9AIE032	Elektrikli Izgara Düz+Oluklu Pleyt Electrical Grill Smooth+Ribbed Plate	1200x900x300	115	0.33	18

TEKNİK ÖZELLİKLER

- Termostatik kumanda.
- Tam modüllerde iki bölgeyi ısıtma.
- Çıkarılabilir yağ toplama haznesi.
- Paslanmaz çelik gövde.

TECHNICAL SPECIFICATIONS

- Thermostatic controller.
- Two separate heating zones.
- Removable oil collecting drawer.
- Stainless steel body.

AND.PLS.9AIE010 / AND.PLS.9AIE011

- Elektrik Girişi: 400V AC 3N PE
- Kablo Kesiti (mm²): 5x2,5

AND.PLS.9AIE020 / AND.PLS.9AIE021 / AND.PLS.9AIE022

- Elektrik Girişi (mm²): 400V AC 3N PE
- Kablo Kesiti (mm²): 5x2,5

AND.PLS.9AIE030 / AND.PLS.9AIE031 / AND.PLS.9AIE032

- Elektrik Girişi (mm²): 400V AC 3N PE
- Kablo Kesiti (mm²): 5x2,5

AND.PLS.9AIE010 / AND.PLS.9AIE011

- Electric Input: 400V AC 3N PE
- Cable Cross Section (mm²): 5x2,5

AND.PLS.9AIE020 / AND.PLS.9AIE021 / AND.PLS.9AIE022

- Electric Input: 400V AC 3N PE
- Cable Cross Section (mm²): 5x2,5

AND.PLS.9AIE030 / AND.PLS.9AIE031 / AND.PLS.9AIE032

- Electric Input: 400V AC 3N PE
- Cable Cross Section (mm²): 5x2,5

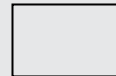

Düz / Smooth



Düz + Oluklu / Smooth + Ribbed



Komple Oluklu / Complete Ribbed

CHROME PLATE

CE



Kod Code	Ürün Adı Description	Ebatlar Dimension	Ağırlık Weight	Net Net	Güç Power
		a x b x c (mm)	(kg)	(m ²)	(kw)
AND.PLS.9AIE010-K	Elektrikli Izgara Düz Krom Pleyt Electrical Grill Smooth Chrome Plate	400x900x300	62	0.11	6
AND.PLS.9AIE011-K	Elektrikli Izgara Komple Oluklu Krom Pleyt Electrical Grill Ribbed Chrome Plate	400x900x300	62	0.11	6
AND.PLS.9AIE020-K	Elektrikli Izgara Düz Krom Pleyt Electrical Grill Smooth Chrome Plate	800x900x300	115	0.22	12
AND.PLS.9AIE021-K	Elektrikli Izgara Komple Oluklu Krom Pleyt Electrical Grill Ribbed Chrome Plate	800x900x300	115	0.22	12
AND.PLS.9AIE022-K	Elektrikli Izgara Düz+Oluklu Krom Pleyt Electrical Grill Smooth+Ribbed Chrome Plate	800x900x300	115	0.22	12
AND.PLS.9AIE030-K	Elektrikli Izgara Düz Krom Pleyt Electrical Grill Smooth Chrome Plate	1200x900x300	115	0.33	18
AND.PLS.9AIE031-K	Elektrikli Izgara-Komple Oluklu Krom Pleyt Electrical Grill Ribbed Chrome Plate	1200x900x300	115	0.33	18
AND.PLS.9AIE032-K	Elektrikli Izgara Düz+Oluklu Krom Pleyt Electrical Grill Smooth+Ribbed Chrome Plate	1200x900x300	115	0.33	18

TEKNİK ÖZELLİKLER

- Termostatik kumanda.
- Tam modüllerde iki bölgeyi ısıtma.
- Çıkarılabilir yağ toplama haznesi.
- Paslanmaz çelik gövde.

TECHNICAL SPECIFICATIONS

- Thermostatic controller.
- Two separate heating zones.
- Removable oil collecting drawer.
- Stainless steel body.

AND.PLS.9AIE010-K / AND.PLS.9AIE011-K

- Elektrik Girişi: 400V AC 3N PE
- Kablo Kesiti (mm²): 5x2,5

AND.PLS.9AIE020-K / AND.PLS.9AIE021-K / AND.PLS.9AIE022-K

- Elektrik Girişi: 400V AC 3N PE
- Kablo Kesiti (mm²): 5x2,5

AND.PLS.9AIE030-K / AND.PLS.9AIE031-K / AND.PLS.9AIE032-K

- Elektrik Girişi: 400V AC 3N PE
- Kablo Kesiti (mm²): 5x2,5

AND.PLS.9AIE010-K / AND.PLS.9AIE011-K

- Electric Input: 400V AC 3N PE
- Cable Cross Section (mm²): 5x2,5

AND.PLS.9AIE020-K / AND.PLS.9AIE021-K / AND.PLS.9AIE022-K

- Electric Input: 400V AC 3N PE
- Cable Cross Section (mm²): 5x2,5

AND.PLS.9AIE030-K / AND.PLS.9AIE031-K / AND.PLS.9AIE032-K

- Electric Input: 400V AC 3N PE
- Cable Cross Section (mm²): 5x2,5

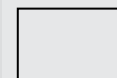

Düz / Smooth



Düz + Oluklu / Smooth + Ribbed



Komple Oluklu / Complete Ribbed

900 Plus Serisi

900 Plus Series

Gazlı Sulu Izgaralar

Gas Vapor Grills

andora



Kod Code	Ürün Adı Description	Ebatlar Dimension	Ağırlık Weight	Net Net	Güç Power
		a x b x c (mm)	(kg)	(m ³)	(kw)
AND.PLS.9ALG010-S	Gazlı Sulu Izgara Gas Vapor Grill	400x900x300	67	0.11	7
AND.PLS.9ALG020-S	Gazlı Sulu Izgara Gas Vapor Grill	800x900x300	128	0.22	14
AND.PLS.9ALG030-S	Gazlı Sulu Izgara Gas Vapor Grill	1200x900x300	171	0.32	21

TEKNİK ÖZELLİKLER

- Buharlaştırma kabini sayesinde daha verimli pişirme.
- Lpg ve Ng ile çalışabilme özelliği.
- Magnet emniyet ventilli ve pilotlu musluklar.
- Paslanmaz çelik gövde.
- Tam modüllerde iki bölgeyi ısıtma.
- Her brülör için piezo çakmak ile kontrol.
- Pik döküm ızgara.

TECHNICAL SPECIFICATIONS

- Steamer cabinet provides fertile cooking.
- Lpg or Natural Gas.
- Magnet safety gas valve and pilot flame.
- Stainless steel body.
- Two separate heating zones.
- Piezo electric ignition system for each burner.
- Cast iron grill.



AND.PLS.9ALG010-S

- Gaz Tüketim Değeri (ng): 0,75 m³/h
- Gaz Tüketim Değeri (lpg): 0,87 kg/h

AND.PLS.9ALG020-S

- Gaz Tüketim Değeri (ng): 1,50 m³/h
- Gaz Tüketim Değeri (lpg): 1,74 kg/h

AND.PLS.9ALG030-S

- Gaz Tüketim Değeri (ng): 2,25 m³/h
- Gaz Tüketim Değeri (lpg): 2,61 kg/h

AND.PLS.9ALG010-S

- Gas Consumption (ng): 0,75 m³/h
- Gas Consumption (lpg): 0,87 kg/h

AND.PLS.9ALG020-S

- Gas Consumption (ng): 1,50 m³/h
- Gas Consumption (lpg): 1,74 kg/h

AND.PLS.9ALG030-S

- Gas Consumption (ng): 2,25 m³/h
- Gas Consumption (lpg): 2,61 kg/h



Kod Code	Ürün Adı Description	Ebatlar Dimension	Ağırlık Weight	Net Net	Güç Power
		a x b x c (mm)	(kg)	(m ³)	(kw)
AND.PLS.9ALG010	Gazlı Lavataşlı Izgara Gas Lavastone Grill	400x900x300	69	0.11	10.30
AND.PLS.9ALG020	Gazlı Lavataşlı Izgara Gas Lavastone Grill	800x900x300	126	0.22	20.60
AND.PLS.9ALG030	Gazlı Lavataşlı Izgara Gas Lavastone Grill	1200x900x300	126	0.33	30.90

TEKNİK ÖZELLİKLER

- Lpg ve Ng ile çalışabilme özelliği.
- Magnet emniyet ventilli ve pilotlu musluklar.
- Tam modüllerde iki bölgeyi ısıtma.
- Paslanmaz çelik gövde.
- Her brulör için piezzo çakmak ile kontrol.
- Çıkarılabilir yağ toplama haznesi.
- Kolay temizlenebilir ve hijyeniktir.

TECHNICAL SPECIFICATIONS

- Lpg or Natural Gas.
- Magnet safety gas valve and pilot flame.
- Two separate heating zones.
- Stainless steel body.
- Piezo electric ignition system for each burner.
- Removable oil collecting drawer.
- Easy to clean and hygienic.



AND.PLS.9ALG010

- Gaz Tüketim Değeri (ng): 1,09 m³/h
- Gaz Tüketim Değeri (lpg): 0,77 kg/h

AND.PLS.9ALG010

- Gas Consumption (ng): 1,09 m³/h
- Gas Consumption (lpg): 0,77 kg/h

AND.PLS.9ALG020

- Gaz Tüketim Değeri (ng): 2,18 m³/h
- Gaz Tüketim Değeri (lpg): 0,86 kg/h

AND.PLS.9ALG020

- Gas Consumption (ng): 2,18 m³/h
- Gas Consumption (lpg): 0,86 kg/h

AND.PLS.9ALG030

- Gaz Tüketim Değeri (ng): 3,27 m³/h
- Gaz Tüketim Değeri (lpg): 1,29 kg/h

AND.PLS.9ALG030

- Gas Consumption (ng): 3,27 m³/h
- Gas Consumption (lpg): 1,29 kg/h

900 Plus Serisi
900 Plus Series

Elektrikli Makarna Haşlama - Patates Dinlendirme Üniteleri
Electrical Pasta Cooker - Chips Scuttle Units

andora

CE



Kod Code	Ürün Adı Description	Ebatlar Dimension	Ağırlık Weight	Net Net	Güç Power
AND.PLS.9AME010	Elektrikli Makarna Haşlama Electrical Pasta Cooker	400x900x850	46	0.30	12

TEKNİK ÖZELLİKLER

- Termostatik kontrol.
- Paslanmaz çelik gövde ve sepetler.
- Su doldurma musluğu.
- Tahliye musluğu ile su boşaltma.
- Taşan su tahliye sistemi.

TECHNICAL SPECIFICATIONS

- Thermostatic control.
- Stainless steel body and baskets.
- Water filling tap.
- Discharge valve.
- Overflow drainage system.

AND.PLS.9AME010

- Elektrik Girişi: 400V AC 3N PE
- Kablo Kesiti (mm²): 5x2,5

AND.PLS.9AME010

- Electric Input: 400V AC 3N PE
- Cable Cross Section (mm²): 5x2,5



Kod Code	Ürün Adı Description	Ebatlar Dimension	Ağırlık Weight	Net Net	Güç Power
AND.PLS.9ADE010	Patates Dinlendirme Ünitesi Chips Scuttle Units	400x900x300	20	0.11	0.65

TEKNİK ÖZELLİKLER

- Kızartılmış patateslerin sıcak bekletilmesinde ve yağların süzülmesinde kullanılır.
- 1/1x150 Gn küvet kapasitesi.
- Infrared seramik ısıtıcı.
- Paslanmaz çelik gövde.
- Havuzda kızartma yağının süzülmesi için maksimum verim sağlayan özel form.

TECHNICAL SPECIFICATIONS

- Operates in order to keep fried food warm and drain oil.
- Capacity: 1/1x150 Gn
- Ceramic infrared heater.
- Stainless steel body.
- Special form on the container, provides maximum efficiency in order to drain oil.

AND.PLS.9ADE010

- Elektrik Girişi: 230V AC N PE
- Kablo Kesiti (mm²): 3x1,5

AND.PLS.9ADE010

- Electric Input: 230V AC N PE
- Cable Cross Section (mm²): 3x1,5



Kod Code	Ürün Adı Description	Ebatlar Dimension	Ağırlık Weight	Net Net	Güç Power
		a x b x c (mm)	(kg)	(m ³)	(kw)
AND.PLS.9ASE010	Elektrikli Benmari Electrical Bainmarie	400x900x800	43	0.11	2.5
AND.PLS.9ASE020	Elektrikli Benmari Electrical Bainmarie	800x900x800	50	0.22	4.4

TEKNİK ÖZELLİKLER

- Termostatik kumanda.
- Paslanmaz çelik gövde.
- Tahliye musluğu.
- Su alma musluğu.
- Kolay temizlenebilir ve hijyeniktir.

AND.PLS.9ASE010

- Kapasite; 1 adet 1/1 Gn.

AND.PLS.9ASE020

- Kapasite; 2 adet 1/1 Gn.

AND.PLS.9ASE010

- Elektrik Girişi: 230V AC N PE
- Kablo Kesiti (mm²): 3x2,5

AND.PLS.9ASE020

- Elektrik Girişi: 230V AC N PE
- Kablo Kesiti (mm²): 3x2,5

TECHNICAL SPECIFICATIONS

- Thermostatic controller.
- Stainless steel body.
- Drainage valve.
- Water inlet valve.
- Easy to clean and hygienic.

AND.PLS.9ASE010

- Capacity; 1 piece 1/1 Gn.

AND.PLS.9ASE020

- Capacity; 2 pieces 1/1 Gn.

AND.PLS.9ASE010

- Electric Input: 230V AC N PE
- Cable Cross Section (mm²): 3x2,5

AND.PLS.9ASE020

- Electric Input: 230V AC N PE
- Cable Cross Section (mm²): 3x2,5



900 Plus Serisi
900 Plus Series

Ara Tezgahlar
Worktops

andora

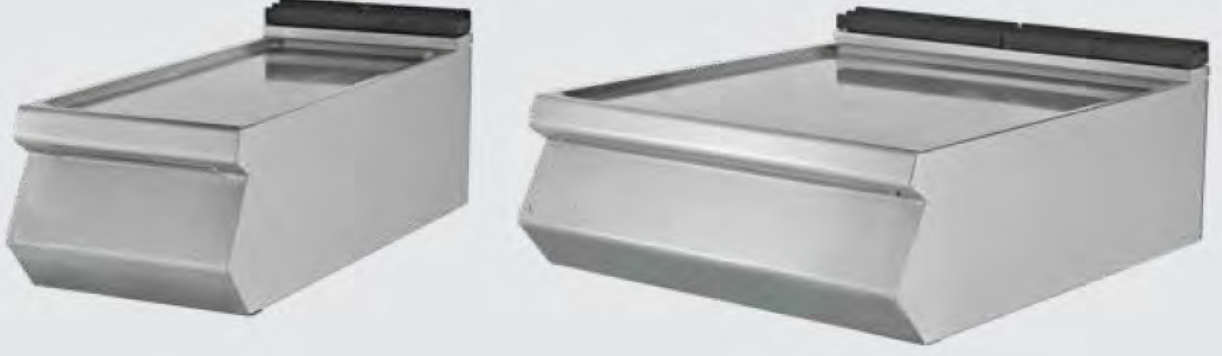

Kod Code	Ürün Adı Description	Ebatlar Dimension	Ağırlık Weight	Net Net
		a x b x c (mm)	(kg)	(m ³)
AND.PLS.9ATN010	Ara Tezgah 1/2 Modül Worktop 1/2 Module	400x900x300	21	0.11
AND.PLS.9ATN020	Ara Tezgah 1/1 Modül Worktop 1/1 Module	800x900x300	30	0.22

TEKNİK ÖZELLİKLER

- Kolay temizlenebilir ve hijyeniktir.
- Paslanmaz çelik gövde.
- Tezgahlar 90 seri cihazların arasında kullanılabilecek uygun ölçülerdedir.

TECHNICAL SPECIFICATIONS

- Easy to clean and hygienic.
- Stainless steel body.
- Worktops are suitable to use for each kind of 90's serie equipments.



Kod Code	Ürün Adı Description	Ebatlar Dimension	Ağırlık Weight	Net Net
		a x b x c (mm)	(kg)	(m ³)
AND.PLS.9ATS010	Set Altı Tezgah 1 Kapaklı Undercounter Cabinet with 1 Door	400x790x550	18	0.15
AND.PLS.9ATS020	Set Altı Tezgah 2 Kapaklı Undercounter Cabinet with 2 Doors	800x790x550	28	0.22
AND.PLS.9ATS030	Set Altı Tezgah 3 Kapaklı Undercounter Cabinet with 3 Doors	1200x790x550	39	0.33



Kod Code	Ürün Adı Description	Ebatlar Dimension	Ağırlık Weight	Net Net
		a x b x c (mm)	(kg)	(m ³)
AND.PLS.9ATS010-K	Set Altı Tezgah Kapaksız Undercounter Cabinet without Door	400x790x550	15	0.15
AND.PLS.9ATS020-K	Set Altı Tezgah Kapaksız Undercounter Cabinet without Door	800x790x550	22	0.22
AND.PLS.9ATS030-K	Set Altı Tezgah Kapaksız Undercounter Cabinet without Door	1200x790x550	30	0.33

TEKNİK ÖZELLİKLER

- Tezgahlar 90 seri cihazların altına kullanılabilecek uygun modüler ölçülerdedir.
- Kolay temizlenebilir ve hijyeniktir.
- Paslanmaz çelik gövde.

TECHNICAL SPECIFICATIONS

- Under-Set Counters are suitable to use under each kind of 90's serie equipments.
- Easy to clean and hygienic.
- Stainless steel body.

900 Plus Serisi
900 Plus Series

Gazlı Devrilir Tavalar
Gas Tilting Pans

andora

CE



Kod Code	Ürün Adı Description	Ebatlar Dimension	Ağırlık Weight	Net Net	Güç Power	Kapasite Capacity
		a x b x c (mm)	(kg)	(m ³)	(kw)	(lt)
AND.PLS.ADTG.80	Gazlı Devrilir Tava Gas Tilting Pan	800x900x850	145	0.62	11.20	80
AND.PLS.ADTG.120	Gazlı Devrilir Tava Gas Tilting Pan	1200x900x850	193	0.9	16.10	120

TEKNİK ÖZELLİKLER

- Lpg ve Ng ile çalışabilme özelliği.
- Magnet emniyet ventilli termokulp ve termostat.
- Manuel kaldırma mekanizması.
- Karşı ağırlıklı kapak.
- Güvenlik sensörü.
- Kolay temizlenebilir ve hijyeniktir.
- Paslanmaz çelik gövde.

TECHNICAL SPECIFICATIONS

- Lpg or Natural Gas.
- Safety gas valve thermocouple and thermostat.
- Manuel lift system.
- Counterweighted hinged lid.
- Safety switch.
- Easy to clean and hygienic.
- Stainless steel body.

AND.PLS.ADTG.80

- Gaz Tüketim Değeri (ng): 1,18 m³/h
- Gaz Tüketim Değeri (lpg): 0,98 kg/h

AND.PLS.ADTG.120

- Gaz Tüketim Değeri (ng): 1,70 m³/h
- Gaz Tüketim Değeri (lpg): 1,21 kg/h

AND.PLS.ADTG.80

- Gas Consumption (ng): 1,18 m³/h
- Gas Consumption (lpg): 0,98 kg/h

AND.PLS.ADTG.120

- Gas Consumption (ng): 1,70 m³/h
- Gas Consumption (lpg): 1,21 kg/h





Kod Code	Ürün Adı Description	Ebatlar Dimension	Ağırlık Weight	Net Net	Güç Power	Kapasite Capacity
		a x b x c (mm)	(kg)	(m ³)	(kw)	(lt)
AND.PLS.ADTE.80	Elektrikli Devrilir Tava Electrical Tilting Pan	800x900x850	148	0.62	12	80
AND.PLS.ADTE.120	Elektrikli Devrilir Tava Electrical Tilting Pan	1200x900x850	190	0.92	12	120

TEKNİK ÖZELLİKLER

- Manuel kaldırma mekanizması.
- Karşı ağırlıklı kapak.
- Kolay temizlenebilir ve hijyeniktir.
- Limit termostat.
- Paslanmaz çelik gövde.
- Termostat kontrol.

TECHNICAL SPECIFICATIONS

- Manuel lift system.
- Counterweighted hinged lid.
- Easy to clean and hygienic.
- Limit thermostat.
- Stainless steel body.
- Thermostat control.

AND.PLS.ADTE.80

- Elektrik Girişi: 400V AC 3N PE
- Kablo Kesiti (mm²): 5x2,5

AND.PLS.ADTE.80

- Electric Input: 400V AC 3N PE
- Cable Cross Section (mm²): 5x2,5

AND.PLS.ADTE.120

- Elektrik Girişi: 400V AC 3N PE
- Kablo Kesiti (mm²): 5x2,5

AND.PLS.ADTE.120

- Electric Input: 400V AC 3N PE
- Cable Cross Section (mm²): 5x2,5



900 Plus Serisi
900 Plus Series

Gazlı Kaynatma Tencereleri (İndirekt)
Gas Boiling Pans (Indirect)

andora

CE



Kod Code	Ürün Adı Description	Ebatlar Dimension	Ağırlık Weight	Net Net	Güç Power	Kapasite Capacity
		a x b x c (mm)	(kg)	(m ³)	(kw)	(lt)
AND.PLS.AKTG.150	Gazlı Kaynatma Tenceresi İndirekt Gas Boiling Pan Indirekt	800x900x850	111	0.62	16.10	150
AND. PLS.AKTG.250	Gazlı Kaynatma Tenceresi İndirekt Gas Boiling Pan Indirekt	1200x900x850	228	0.92	32.20	250

TEKNİK ÖZELLİKLER

- Lpg ve Ng ile çalışabilme özelliği.
- Magnet emniyet ventilli termokulp ve termostat.
- Aşırı basınç valfi ve manometre.
- Su doldurma musluğu.
- Tahliye Musluğu.
- Karşı ağırlıklı kapak.
- Çift cidarlı ceket.
- Kolay temizlenebilir ve hijyeniktir.
- Limit termostat.
- Paslanmaz çelik gövde.

TECHNICAL SPECIFICATIONS

- Lpg or Natural Gas.
- Safety gas valve thermocouple and thermostat.
- Over pressure safety valve and manometer.
- Water inlet valve.
- Drainage valve.
- Counterweighted hinged lid.
- Double jacket pan.
- Easy to clean and hygienic.
- Limit thermostat.
- Stainless steel body.

AND.PLS.AKTG.150

- Gaz Tüketim Değeri (ng): 1,70 m³/h
- Gaz Tüketim Değeri (lpg): 1,21 kg/h

AND. PLS.AKTG.250

- Gaz Tüketim Değeri (ng): 3,40 m³/h
- Gaz Tüketim Değeri (lpg): 2,42 kg/h

AND.PLS.AKTG.150

- Gas Consumption (ng): 1,70 m³/h
- Gas Consumption (lpg): 1,21 kg/h

AND. PLS.AKTG.250

- Gas Consumption (ng): 3,40 m³/h
- Gas Consumption (lpg): 2,42 kg/h





Kod Code	Ürün Adı Description	Ebatlar Dimension	Ağırlık Weight	Net Net	Güç Power	Kapasite Capacity
		a x b x c (mm)	(kg)	(m ³)	(kw)	(lt)
AND. PLS.AKTE.150	Elektrikli Kaynatma Tenceresi İndirekt Electrical Boiling Pan Indirekt	800x900x850	111	0.62	18	150
AND. PLS.AKTE.250	Elektrikli Kaynatma Tenceresi İndirekt Electrical Boiling Pan Indirekt	1200x900x850	197	0.92	30	250

TEKNİK ÖZELLİKLER

- Aşırı basınç valfi ve manometre.
- Su doldurma musluğu.
- Tahliye Musluğu.
- Karşı ağırlıklı kapak.
- Çift cidarlı ceket.
- Kolay temizlenebilir ve hijyeniktir.
- Limit termostat.
- Paslanmaz çelik gövde.
- Termostat kontrol.

TECHNICAL SPECIFICATIONS

- Over pressure safety valve and manometer.
- Water inlet valve.
- Drainage valve.
- Counterweighted hinged lid.
- Double jacket pan.
- Easy to clean and hygienic.
- Limit thermostat.
- Stainless steel body.
- Thermostat control.

AND.PLS.AKTE.150

- Elektrik Girişi: 400V AC 3N PE
- Kablo Kesiti (mm²): 5x6

AND. PLS.AKTE.250

- Elektrik Girişi: 400V AC 3N PE
- Kablo Kesiti (mm²): 5x10

AND.PLS.AKTE.150

- Electric Input: 400V AC 3N PE
- Cable Cross Section (mm²): 5x6

AND.PLS.AKTE.250

- Electric Input: 400V AC 3N PE
- Cable Cross Section (mm²): 5x10

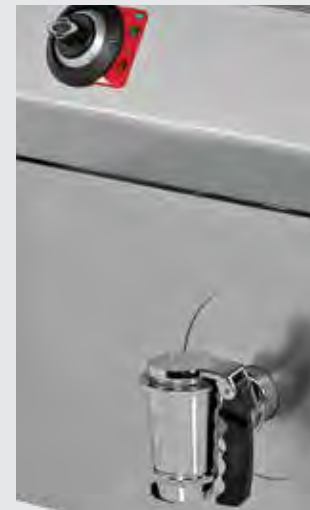

900 Plus Serisi
900 Plus Series

Cantilever Hat
Cantilever Line

andora



Kod Code	Ürün Adı Description	Ebatlar Dimension
		a x b x c (mm)

AND.PLS.9ACTV240 Cantilever Hat
Cantilever Line 2400x1710x550

Kod Code	Ürün Adı Description	Ebatlar Dimension
		a x b x c (mm)

AND.PLS.9ACTV280 Cantilever Hat
Cantilever Line 2800x1710x550

Kod Code	Ürün Adı Description	Ebatlar Dimension
		a x b x c (mm)

AND.PLS.9ACTV320 Cantilever Hat
Cantilever Line 3200x1710x550

Kod Code	Ürün Adı Description	Ebatlar Dimension
		a x b x c (mm)

AND.PLS.9ACTV360 Cantilever Hat
Cantilever Line 3600x1710x550

Kod Code	Ürün Adı Description	Ebatlar Dimension
		a x b x c (mm)

AND.PLS.9ACTV400 Cantilever Hat
Cantilever Line 4000x1710x550

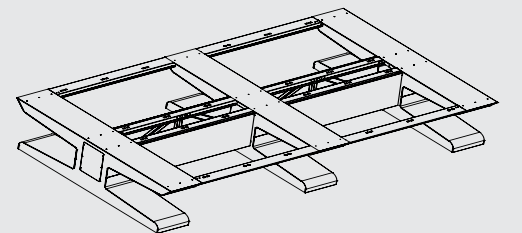
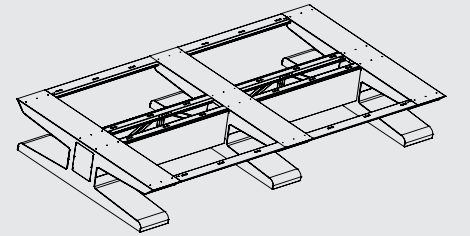
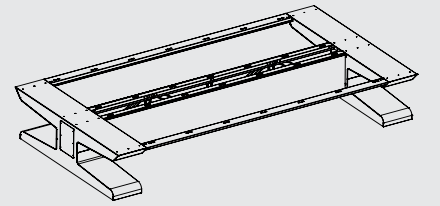
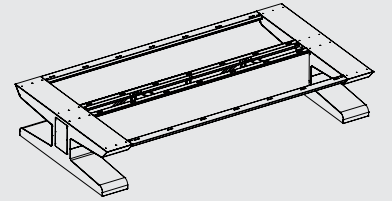
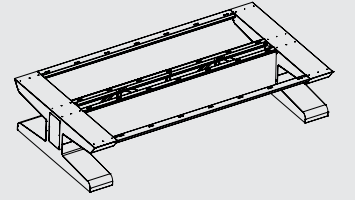

Gazlı fritözler, Elektrikli fritözler, Elektrikli Benmariler, Elektrikli Makarna Haşlama ünitelerinde ALT KISIM dolaplı olarak gelmektedir.
For Gas Fryers, Electrical Fryers, Electrical Bainmaries and Electrical Pasta Cookers BOTTOM SIDE includes cabinet.

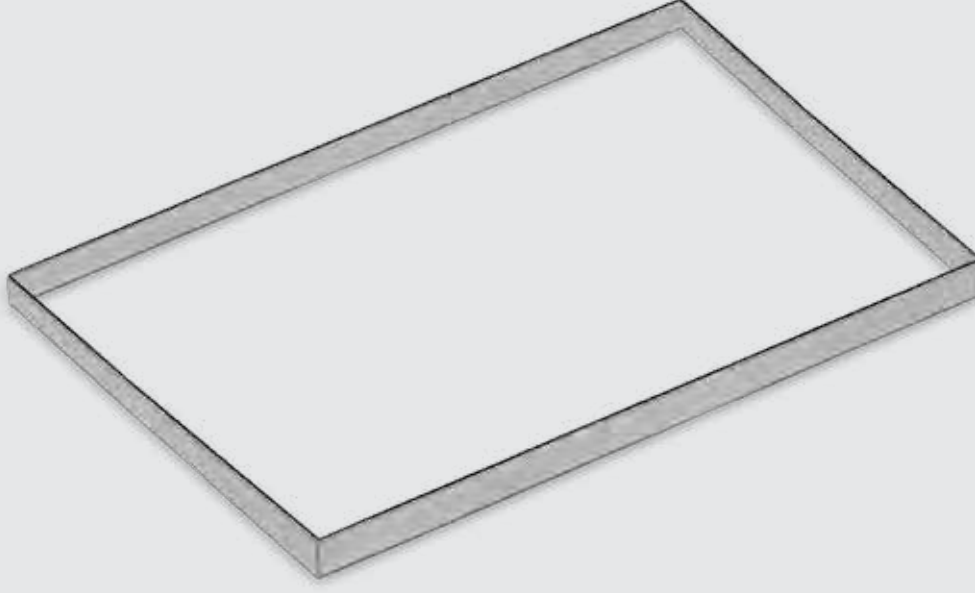

Kod Code	Ürün Adı Description	Ebatlar Dimension
		a x b x c (mm)
AND.PLS.9ASBP240	Paslanmaz Alt Baza 240 cm Stainless Steel Frame 240 cm	2400x1370x550
AND.PLS.9ASBP280	Paslanmaz Alt Baza 280 cm Stainless Steel Frame 280 cm	2800x1370x550
AND.PLS.9ASBP320	Paslanmaz Alt Baza 320 cm Stainless Steel Frame 320 cm	3200x1370x550
AND.PLS.9ASBP360	Paslanmaz Alt Baza 360 cm Stainless Steel Frame 360 cm	3600x1370x550
AND.PLS.9ASBP400	Paslanmaz Alt Baza 400 cm Stainless Steel Frame 400 cm	4000x1370x550



Firinlar Ovens



andora

andora

FIRINLAR

- Gazlı Tandır Fırınları
- Profesyonel Kömürlü Fırınlr
- Kuzu Pişirme Fırınları
- Asansörlü Kömürlü Izgara
- Gazlı Plus Konveksiyonlu Fırınlr
- Elektrikli Plus Konveksiyonlu Fırınlr
- İthal Kombi Fırınlr**
- Gazlı Kombi Fırınlr
- Elektrikli Kombi Fırınlr
- Fırınlr (Pastane)**
- Elektrikli Mini Konveksiyonlu Fırınlr
- Elektrikli Konveksiyonlu Patisserie Fırınları
- Gazlı Plus Konveksiyonlu Patisserie Fırınları
- Elektrikli Plus Konveksiyonlu Patisserie Fırınları
- Elektrikli Kombi Fırınlr (Büyük - Küçük Model)
- Elektrikli Modüler Fırınlr (Touch Screen)
- Elektrikli Döner Konveksiyonlu Fırınlr
- Gazlı Döner Konveksiyonlu Fırınlr
- Profesyonel Mayalandırma Kabinleri
- Otomatik Programlı Fermantasyon Dolabı (Sıcak-Soğuk)
- Pizza Fırınları**
- Elektrikli Döner Tabanlı Pizza Fırınları
- Gazlı Döner Tabanlı Pizza Fırınları
- Gazlı Sabit Tabanlı Pizza Fırınları
- Gazlı ve Odunlu Döner Tabanlı Pizza Fırınları
- Gazlı Pizza ve Pide Fırınları
- Gazlı Pide Lahmacun Fırınları (Emniyet Ventilli)
- Elektrikli Gold Midi Pizza Fırınları
- Elektrikli Gold Maxi Pizza Fırınları
- Elektrikli Pizza Fırınları Tek Katlı
- Elektrikli Pizza Fırınları İki Katlı
- Gazlı Pizza Fırınları Tek Katlı
- Gazlı Pizza Fırınları İki Katlı
- Elektrikli Konveyörlü Pizza Fırınları
- Gazlı Konveyörlü Pizza Fırınları
- Gazlı Pasta Börek Fırınları (Emniyet Ventilli)

OVENS

- Gas Tandoori Ovens
- Professional Charcoal Ovens
- Lamb Baking Ovens
- Lifted Charcoal Grills
- Gas Plus Convection Ovens
- Electrical Plus Convection Ovens
- Imported Combi Ovens**
- Gas Combi Ovens
- Electrical Combi Ovens
- Ovens (Patisserie)**
- Electrical Mini Convection Ovens
- Electrical Convection Patisserie Ovens
- Gas Plus Convection Patisserie Ovens
- Electrical Plus Convection Patisserie Ovens
- Electrical Combi Ovens (Big - Small Model)
- Electrical Modular Ovens (Touch Screen)
- Electric Convection Rotary Ovens
- Gas Convection Rotary Ovens
- Professional Fermentation Cabinets
- Automatic Programmed Retarder Proofer (Hot-Cold)
- Pizza Ovens**
- Electrical Rotating Base Pizza Ovens
- Gas Rotating Base Pizza Ovens
- Gas Fixed Base Pizza Ovens
- Gas and Wood Rotating Pizza Ovens
- Gas Pizza Ovens
- Gas Pitta and Turkish Pizza Ovens (with Safety Valve)
- Electric Gold Midi Pizza Ovens
- Electric Gold Maxi Pizza Ovens
- Electrical Single Layer Pizza Ovens
- Electrical Two Layer Pizza Ovens
- Gas Single Layer Pizza Ovens
- Gas Two Layer Pizza Ovens
- Electrical Conveyor Pizza Ovens
- Gas Conveyor Pizza Ovens
- Gas Pastry Ovens (with Safety Valve)



Kod Code	Ürün Adı Description	Ebatlar Dimension	Ağırlık Weight	Net Net	Güç Power
		a x b x c (mm)	(kg)	(m ³)	(kw)
AND.ATDR.01	Gazlı Tandır Fırını Gas Tandoori Oven	706x1018x1440	291	1.03	64.80

TEKNİK ÖZELLİKLER

- LPG veya NG ile çalışır.
- Musluklar Magnet Emniyet ventillidir.
- 66 cm iç hazne ebatı.
- İzolasyonlu gövde.
- Çıkarılabilir pislik tavası.
- Paslanmaz çelik gövde.

TECHNICAL SPECIFICATIONS

- Adaptable LPG or NG
- Magnet Safety valves.
- 66 cm dorne dimension.
- Insulated body.
- Removable tray for waste collection.
- Stainless Steel Body.



AND.ATDR.01

- Gaz Tüketim Değeri (ng): 6,85 m³/h
- Gaz Tüketim Değeri (lpg): 4,86 kg/h

AND.ATDR.01

- Gas Consumption (ng): 6,85 m³/h
- Gas Consumption (lpg): 4,86 kg/h



Kod Code	Ürün Adı Description	Ebatlar Dimension a x b x c (mm)	Ağırlık Weight (kg)	Net Net (m³)	Tel Izgara Grill Rack (mm)
AND.APKF-40-K	Profesyonel Kömürlü Fırın Kırmızı Professional Charcoal Oven Red	740x745x650/1210	180	0.68	560x524
AND.APKF-40-S	Profesyonel Kömürlü Fırın Siyah Professional Charcoal Oven Black	740x745x650/1210	180	0.68	560x524
AND.APKF-40- US	Üst Dinlendirme Top Grill	715x630x251	20	0.11	
AND.APKF-40-AS	Fırın Alt Standı Oven Bottom Stand	730x730x790	40	0.39	
AND.APKF-40- D	Paslanmaz Alt Dolap Kapaklı Stainless Steel Bottom Cabinet with Door	705x690x782	43	0.38	

TEKNİK ÖZELLİKLER

- 500 °C çalışma ısısı.
- 560x524 mm tel ızgara ebatı.
- Saatte 20 kg et kapasitesi.
- Kül çekmecesi.
- Standart davlumbaz.
- Paslanmaz çelik gövde.

TECHNICAL SPECIFICATIONS

- 500 °C working temperature.
- 560x524 mm grill rack size.
- 20 kg meat / h capacity.
- Ash drawer.
- Standard hood.
- Stainless Steel Body.



AND.APKF-40- US



AND.APKF-40-AS



AND.APKF-40- D



Kod Code	Ürün Adı Description	Ebatlar Dimension a x b x c (mm)	Ağırlık Weight (kg)	Net Net (m ³)	Tel Izgara Grill Rack (mm)
AND.APKF-50-K	Profesyonel Kömürlü Fırın Kırmızı Professional Charcoal Oven Red	920x850x650/1320	260	0.97	740x650
AND.APKF-50-S	Profesyonel Kömürlü Fırın Siyah Professional Charcoal Oven Black	920x850x650/1320	260	0.97	740x650
AND.APKF-50-US	Üst Dinlendirme Top Grill	896x730x251	27	0.16	
AND.APKF-50-AS	Fırın Alt Standı Oven Bottom Stand	920x845x815	56	0.54	
AND.APKF-50-D	Paslanmaz Alt Dolap Kapaklı Stainless Steel Bottom Cabinet with Door	890x770x805	52	0.52	

TEKNİK ÖZELLİKLER

- 500 °C çalışma ısısı.
- 740x650 mm tel ızgara ebatı.
- Saatte 20 kg et kapasitesi.
- Kül çekmecesi.
- Standart davlumbaz.
- Paslanmaz çelik gövde.

TECHNICAL SPECIFICATIONS

- 500 °C working temperature.
- 740x650 mm grill rack size.
- 20 kg meat / h capacity.
- Ash drawer.
- Standard hood.
- Stainless Steel Body.



AND.APKF-40-US



AND.APKF-40-AS



AND.APKF-40-D



Kod Code	Ürün Adı Description	Ebatlar Dimension	Ağırlık Weight	Net Net	Güç Power
		a x b x c (mm)	(kg)	(m ³)	(kw)
AND.AKFR.01	Kuzu Pişirme Fırını Tek Katlı Lamb Baking Oven Single Layer	1210x973x850	165	1	16.5
AND.AKFR.02	Kuzu Pişirme Fırını 2 Katlı Lamb Baking Oven Double Layer	1210x973x1585	320	1.87	33

TEKNİK ÖZELLİKLER

- Aynı anda elektrikli rezistans ve gazlı brülörle çalışma sistemi.
- Fırın üstünde 2 adet 1,5 kW elektrik rezistansı ve alt kısmında gazlı brülör ısıtma sistemi.
- LPG veya NG ile çalışır.
- Musluklar Magnet Emniyet ventillidir.
- Piezzo çakmak ile kontrol.
- Kolay temizlenebilir ve hijyeniktir.
- Paslanmaz çelik gövde.

AND.AKFR.01

- Gaz Tüketim Değeri (ng): 1,72 m³/h
- Gaz Tüketim Değeri (lpg): 1,29 kg/h

AND.AKFR.02

- Gaz Tüketim Değeri (ng): 3,44 m³/h
- Gaz Tüketim Değeri (lpg): 2,59 kg/h

TECHNICAL SPECIFICATIONS

- Working system with electrical resistance and gas burner at the same time.
- 2 pieces of 1.5 kW electrical resistances on the oven and gas burner heating system at the bottom.
- Adaptable LPG or NG
- Magnet Safety valves.
- Piezo lighter ignition system.
- Easy to clean and hygienic.
- Stainless Steel Body.

AND.AKFR.01

- Gas Consumption (ng): 1,72 m³/h
- Gas Consumption (lpg): 1,29 kg/h

AND.AKFR.02

- Gas Consumption (ng): 3,44 m³/h
- Gas Consumption (lpg): 2,59 kg/h





Kod Code	Ürün Adı Description	Ebatlar Dimension	Ağırlık Weight	Net Net
		a x b x c (mm)	(kg)	(m³)
AND.ABTG.01	Asansörlü Kömürlü Izgara Lifted Charcoal Grill	940x800x900/1685	160	1.13
AND.ABTG.02	Asansörlü Kömürlü Izgara Lifted Charcoal Grill	1340x800x900/1685	226	1.69

TEKNİK ÖZELLİKLER

- Isıya dayanıklı paslanmaz çelik asansör sistemi.
- Kül Haznesi.
- Kömür depolama dolabı.
- Hızlı ateşleme için hava kanalı.
- Paslanmaz çelik gövde.

AND.ABTG.01

- 660x530 mm tel ızgara ebatı, 680x220 mm ebatında dinlendirme ızgarası.

AND.ABTG.02

- 1060x530 mm tel ızgara ebatı, 1080x220 mm ebatında dinlendirme ızgarası.

TECHNICAL SPECIFICATIONS

- Heatproof stainless steel lift system.
- Ash drawer.
- Charcoal storage cabinet.
- Air flap.
- Stainless steel body.

AND.ABTG.01

- 660x530 mm grill rack size, 680x220 mm over grill size.

AND.ABTG.02

- 1060x530 mm grill rack size, 1080x220 mm over grill size.





Tüm modellerde tepsi kitleri fiyata dahildir.
Tray kits are included in the price for each model.



Kod Code	Ürün Adı Description	Ebatlar Dimension	Ağırlık Weight	Net Net	Güç Power	Kapasite Capacity
		a x b x c (mm)	(kg)	(m ³)	(kw)	(gn)
AND.AGKF-10	Gazlı Plus Konveksiyonlu Fırın Gas Plus Convection Oven	1040x1035x1150	195	1.24	35	10x(1/1 Gn)
AND. AGKF-20	Gazlı Plus Konveksiyonlu Fırın Gas Plus Convection Oven	1241x1105x1134	221	1.55	35	20x(1/1 Gn) 10x(2/1 Gn)
AND.AAS-10	Fırın Alt Standı Oven Bottom Stand	1060x910x622	24	0.60		
AND.AAS-20	Fırın Alt Standı Oven Bottom Stand	1255x980x622	26	0.77		

TEKNİK ÖZELLİKLER

- Manuel nemlendirme özelliği.
- Ayarlanabilir pişirme süresi.
- Dijital sıcaklık göstergesi.
- 0/300 °C arasında ayarlanabilir pişirme sıcaklığı.
- 360 °C lik limit termostat.
- Paslanmaz çelik kapalı sistem ısı transfer boruları.
- Lpg ve Ng ile çalışabilme özelliği.
- Çift yöne dönebilen fan ile eşit ısı dağılımı.
- Silikon contalı temperlenmiş cam.
- Kolay temizlik imkanı sağlayan açılabilir iç cam.
- Sensörlü kapı sistemi.
- Paslanmaz çelik gövde.

TECHNICAL SPECIFICATIONS

- Manual steam system.
- Adjustable cooking time.
- Digital temperature display.
- Adjustable cooking temperature between 0/300 °C
- Safety thermostat for overheating protection 360 °C
- Stainless steel heat exchanger sealed system pipes.
- Lpg or Natural Gas.
- Dual direction fan provides homogenous heat distribution.
- Silicone sealed tempered glass.
- Easy-access interior glass in order to provide cleaning.
- Door switch system.
- Stainless steel body.

AND.AGKF-10 / AND.AGKF-20

- Gaz Tüketim Değeri (ng): 3,70 m³/h
- Gaz Tüketim Değeri (lpg): 2,74 kg/h

AND.AGKF-10 / AND.AGKF-20

- Gas Consumption (ng): 3,70 m³/h
- Gas Consumption (lpg): 2,74 kg/h



Bir adet 1/1 40 Gn tepsi taşıma arabası ve tepsi kiti fiyata dahildir.
One piece of 1/1 40 Gn tray carrying trolley and tray kit is included in the price.



Kod Code	Ürün Adı Description	Ebatlar Dimension	Ağırlık Weight	Net Net	Güç Power	Kapasite Capacity
		a x b x c (mm)	(kg)	(m ³)	(kw)	(gn)
AND.AGKF.40	Gazlı Plus Konveksiyonlu Fırın Gas Plus Convection Oven	1235x1110x1900	394	2.60	46.50	40x(1/1 Gn) 20x(2/1 Gn)
AND.ATA.12-40x60	Patisserie Tepsi Arabası ve Tepsi Kiti Patisserie Tray Trolley and Tray Kit	685x900x1735	58	1.07		12x(40x60) tepsi/tray
AND.ATA-12.Y	Tepsi Taşıma Arabası ve Tepsi Kiti Tray Carrying Trolley and Tray Kit	685x900x1735	58	1.07		24x(1/1 Gn) 12x(2/1 Gn)
AND.ATA-16.Y	Tepsi Taşıma Arabası ve Tepsi Kiti Tray Carrying Trolley and Tray Kit	685x900x1735	51	1.07		32x(1/1 Gn) 16x(2/1 Gn)
AND.ATA-20.Y	Tepsi Taşıma Arabası ve Tepsi Kiti Tray Carrying Trolley and Tray Kit	685x900x1735	51	1.07		40x(1/1 Gn) 20x(2/1 Gn)

TEKNİK ÖZELLİKLER

- Manuel nemlendirme özelliği.
- Ayarlanabilir pişirme süresi.
- Dijital sıcaklık göstergesi.
- 0/300 °C arasında ayarlanabilir pişirme sıcaklığı.
- 360 °C lik limit termostat.
- Paslanmaz çelik kapalı sistem ısı transfer boruları.
- Lpg ve Ng ile çalışabilme özelliği.
- Çift yöne dönebilen fan ile eşit ısı dağılımı.
- Silikon contalı temperlenmiş cam.
- Kolay temizlik imkanı sağlayan açılabilir iç cam.
- Sensörlü kapı sistemi.
- Paslanmaz çelik gövde.

TECHNICAL SPECIFICATIONS

- Manual steam system.
- Adjustable cooking time.
- Digital temperature display.
- Adjustable cooking temperature between 0/300 °C
- Safety thermostat for overheating protection 360 °C
- Stainless steel heat exchanger sealed system pipes.
- Lpg or Natural Gas.
- Dual direction fan provides homogenous heat distribution.
- Silicone sealed tempered glass.
- Easy-access interior glass in order to provide cleaning.
- Door switch system.
- Stainless steel body.

AND.AGKF.40

- Gaz Tüketim Değeri (ng): 4,92 m³/h
- Gaz Tüketim Değeri (lpg): 3,65 kg/h

AND.AGKF.40

- Gas Consumption (ng): 4,92 m³/h
- Gas Consumption (lpg): 3,65 kg/h



Unlu mamüller pişirmek için AND.ATA.12-40x60 tepsi taşıma arabasını ve tepsi kitini kullanınız.
Please use AND.ATA.12-40x60 patisserie tray carrying trolley and tray kit in purpose of cooking bakery products.



Tüm modellerde tepsi kitleri fiyata dahildir.
Tray kits are included in the price for each model.



Kod Code	Ürün Adı Description	Ebatlar Dimension	Ağırlık Weight	Net Net	Güç Power	Kapasite Capacity
		a x b x c (mm)	(kg)	(m ³)	(kw)	(gn)
AND.AEKF-10	Elektrikli Plus Konveksiyonlu Fırın Electrical Plus Convection Oven	1060x1095x1624	181	1.89	16,5	10x(1/1 Gn)
AND.AEKF-20	Elektrikli Plus Konveksiyonlu Fırın Electrical Plus Convection Oven	1241x1108x1134	198	1.56	24	20x(1/1 Gn) 10x(2/1 Gn)
AND.AAS-10	Fırın Alt Standı Oven Bottom Stand	1060x910x622	24	0.60		
AND.AAS-20	Fırın Alt Standı Oven Bottom Stand	1255x980x622	26	0.77		

TEKNİK ÖZELLİKLER

- Manuel nemlendirme özelliği.
- Ayarlanabilir pişirme süresi ve dijital sıcaklık göstergesi.
- 0/300 °C arasında ayarlanabilir pişirme sıcaklığı.
- 360 °C lik limit termostat.
- Paslanmaz çelik kapalı sistem ısı transfer boruları.
- Çift yöne dönebilen fan ile eşit ısı dağılımı.
- Silikon contalı temperlenmiş cam.
- Kolay temizlik imkanı sağlayan açılabilir iç cam.
- Sensörlü kapı sistemi.
- Paslanmaz çelik gövde.

TECHNICAL SPECIFICATIONS

- Manual steam system.
- Adjustable cooking time and digital temperature display.
- Adjustable cooking temperature between 0/300 °C
- Safety thermostat for overheating protection 360 °C
- Stainless steel heat exchanger sealed system pipes.
- Dual direction fan provides homogenous heat distribution.
- Silicone sealed tempered glass.
- Easy-access interior glass in order to provide cleaning.
- Door switch system.
- Stainless steel body.

AND.AEKF-10 / AND.AEKF-20

- Elektrik Girişi: 400V AC 3N PE
- Kablo Kesiti (mm²): 5x6

AND.AEKF-10 / AND.AEKF-20

- Electric Input: 400V AC 3N PE
- Cable Cross Section (mm²): 5x6



Bir adet 1/1 40 Gn tepsi taşıma arabası ve tepsi kiti fiyata dahildir.
One piece of 1/1 40 Gn tray carrying trolley and tray kit is included in the price.



Kod Code	Ürün Adı Description	Ebatlar Dimension	Ağırlık Weight	Net Net	Güç Power	Kapasite Capacity
		a x b x c (mm)	(kg)	(m ³)	(kw)	(gn)
AND.AEKF-40	Elektrikli Plus Konveksiyonlu Fırın Electrical Plus Convection Oven	1235x1110x1900	366	2.60	47,5	40x(1/1 Gn) 20x(2/1 Gn)
AND.ATA.12-40x60	Patisserie Tepsisi Arabası ve Tepsi Kiti Patisserie Tray Trolley and Tray Kit	685x900x1735	58	1.06		12x(40x60) tepsi/tray
AND.ATA-12.Y	Tepsi Taşıma Arabası ve Tepsi Kiti Tray Carrying Trolley and Tray Kit	685x900x1735	58	1.06		24x(1/1 Gn) 12x(2/1 Gn)
AND.ATA-16.Y	Tepsi Taşıma Arabası ve Tepsi Kiti Tray Carrying Trolley and Tray Kit	685x900x1735	51	1.06		32x(1/1 Gn) 16x(2/1 Gn)
AND.ATA-20.Y	Tepsi Taşıma Arabası ve Tepsi Kiti Tray Carrying Trolley and Tray Kit	685x900x1735	51	1.06		40x(1/1 Gn) 20x(2/1 Gn)

TEKNİK ÖZELLİKLER

- Manuel nemlendirme özelliği.
- Ayarlanabilir pişirme süresi ve dijital göstergesi.
- 0/300 °C arasında ayarlanabilir pişirme sıcaklığı
- 360 °C lik limit termostat.
- Paslanmaz çelik kapalı sistem ısı transfer boruları.
- Çift yöne dönebilen fan ile eşit ısı dağılımı.
- Silikon contalı temperlenmiş cam.
- Kolay temizlik imkanı sağlayan açılabilir iç cam.
- Sensörlü kapı sistemi.
- Paslanmaz çelik gövde.

TECHNICAL SPECIFICATIONS

- Manual steam system.
- Adjustable cooking time and digital temperature display.
- Adjustable cooking temperature between 0/300 °C
- Safety thermostat for overheating protection 360 °C
- Stainless steel heat exchanger sealed system pipes.
- Dual direction fan provides homogenous heat distribution.
- Silicone sealed tempered glass.
- Easy-access interior glass in order to provide cleaning.
- Door switch system.
- Stainless steel body.

AND.AEKF-40

- Elektrik Girişi: 400V AC 3N PE
- Kablo Kesiti (mm²): 5x10

AND.AEKF-40

- Electric Input: 400V AC 3N PE
- Cable Cross Section (mm²): 5x10

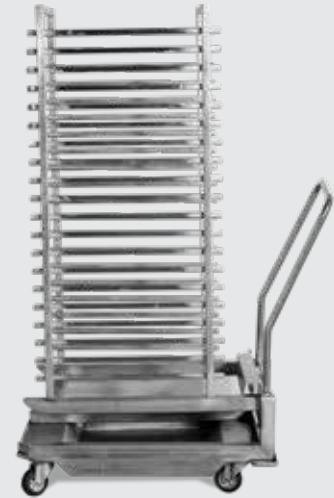

Unlu mamüller pişirmek için AND.ATA.12-40x60 tepsi taşıma arabasını ve tepsi kitini kullanınız.
Please use AND.ATA.12-40x60 patisserie tray carrying trolley and tray kit in purpose of cooking bakery products.



Tüm modellerde tepsi kitleri fiyata dahildir.
Tray kits are included in the price for each model.



Kod Code	Ürün Adı Description	Ebatlar Dimension	Ağırlık Weight	Net Net	Güç Power	Kapasite Capacity
		a x b x c (mm)	(kg)	(m ³)	(kw)	(gn)
AND.AEKF-6	Elektrikli Konveksiyonlu Fırın Electrical Convection Oven	800x855x721	106	0.49	10	6x(1/1 Gn)
AND.AASK-6	Fırın Alt Standı Oven Bottom Stand	865x815x850	34	0.60		

TEKNİK ÖZELLİKLER

- Çift yöne dönebilen fan ile eşit ısı dağılımı.
- Ayarlanabilir pişirme süresi ve dijital sıcaklık göstergesi.
- 0/300 °C arasında ayarlanabilir pişirme sıcaklığı.
- 360 °C lik limit termostat.
- Manuel nemlendirme özelliği.
- Silikon contalı temperlenmiş cam.
- Sensörlü kapı sistemi.
- Paslanmaz çelik gövde.

TECHNICAL SPECIFICATIONS

- Dual direction fan provides homogenous heat distribution.
- Adjustable cooking time and digital temperature display.
- Adjustable cooking temperature between 0/300 °C
- Safety thermostat for overheating protection 360 °C
- Manuel steam.
- Silicone sealed tempered glass.
- Switch system on the door.
- Stainless steel body.

AND.AEKF-6

- Elektrik Girişi: 400V AC 3N PE
- Kablo Kesiti: 5x2,5

AND.AEKF-6

- Electric Input: 400V AC 3N PE
- Cable Cross Section: 5x2,5

andora

İTHAL KOMBI FIRINLAR

Gazlı Kombi Fırınlar
Elektrikli Kombi Fırınlar

IMPORTED COMBI OVENS

Gas Combi Ovens
Electrical Combi Ovens



Fırınlar Ovens

Gazlı Kombi Fırınlar Gas Combi Ovens

andora



Kod Code	Ürün Adı Description	Ebatlar Dimension	Ağırlık Weight	Net Net	Güç Power	Kapasite Capacity
		a x b x c (mm)	(kg)	(m ³)	(kw)	(gn)
ANDCBG6	Gazlı Kombi Fırın Gas Combi Oven	920x874x730	185	1	13.5	6x(1/1 Gn)
ANDCBG10	Gazlı Kombi Fırın Gas Combi Oven	920x874x975	213	1.2	19.5	10x(1/1 Gn)
ANDCBG6-AS	Fırın Alt Standı Oven Bottom Stand	740x850x700	25	0.45		
ANDCBG10-AS	Fırın Alt Standı Oven Bottom Stand	700x860x600	30	0.3		
ANDTTK01	Tütsüleme Kiti Smoker Kit	230x355x120	5.2	0.01	0.15	

TEKNİK ÖZELLİKLER

- 230V 50 Hz çalışma gücü.
- LPG ve NG ile çalışabilme özelliği.
- Pişirme sırasında enerji sarfiyatını düşüren ECO fonksiyonu.
- PLUS ekstra güç fonksiyonu (gaz).
- SC2 yarı otomatik yıkama.
- 99 programlı pişirme hafızası : 4 fazlı; 3 ısıtma, 4 düşük dereceli pişirme ve 1 delta T programı.
- Tek noktalı pişirme probu.
- UR2 pişirme esnasında otomatik nem kontrolü.
- RDC ekonomik buhar jenerasyonu sistemi.
- Ters yönlü 2 kademeli AWC fan.
- Manuel buhar enjeksiyonu.
- Alarmla uyarı verebilen arıza teşhis özelliği.
- IPX5 koruma derecesi.
- Çift temperli camlı kapı.
- 304 kalite paslanmaz dış gövde, 316 kalite fırın iç yapısı.
- Kapalı kapı ile fırın içi soğutma fonksiyonu.
- Set edilen ve ölçülen sıcaklık değerlerini ayrı ayrı gösterebilme özelliği.
- Düşük sıcaklıklı veya yüksek sıcaklıklı buhar üretebilme özelliği.
- Kendi kendini yıkayabilme özelliği.

TECHNICAL SPECIFICATIONS

- 230V 50 Hz operation power.
- Lpg or Natural Gas.
- ECO function for consumption reduction in cooking.
- PLUS extra power function (gas).
- SC2 semi automatic washing.
- Cooking modes: manual or programmable selection, 99 programs with 4 phases of whom 7 are standard, 3 re-heating programs, 5 smoking, 4 Low Temperature and 1 Delta T.
- Single-point temperature core probe.
- UR2 automatic humidity control while cooking.
- RDC steam generator with low management cost.
- Automatic fan reverse AWC, 2 fan speeds.
- Manual steam injection.
- Self-diagnosis with malfunction alarms.
- IPX5 protection degree.
- Door double tempered glazing.
- AISI 304 stainless steel polished cooking chamber ,with AISI 316L (1,2 mm) top and bottom and rounded edges without joints.
- Automatic Cooling and Preheating.
- Display of set and current cooking values.
- Low temperature steam and Superheated steam.
- Self cleaning system.



Tütsüleme Kiti
Smoker Kit

Tüm modellerde tepsi kiti fiyata dahildir.
Tray kits are included in the price for each model.



Kod Code	Ürün Adı Description	Ebatlar Dimension	Ağırlık Weight	Net Net	Güç Power	Kapasite Capacity
		a x b x c (mm)	(kg)	(m ³)	(kw)	(gn)
ANDCBG24	Gazlı Kombi Fırın Gas Combi Oven	1178x1064x1190	283	2.9	32	12x(2/1 Gn)
ANDCBG40	Gazlı Kombi Fırın Gas Combi Oven	1190x1074x1795	449	3.4	55	40x(1/1 Gn)
ANDCBG24-AS	Fırın Alt Standı Oven Bottom Stand	1210x860x600	32	0.6		
ANDCBG40.TA-16	Tepsi Arabası ve Tepsi Kiti Tray Trolley and Tray Kit	590x750x1700	77	1.5		15x(40x60) tepsi/tray
ANDCBG40.TA-20	Tepsi Arabası ve Tepsi Kiti Tray Trolley and Tray Kit	820x920x1710	77	1.5		20x(2/1 Gn)
ANDTTK01	Tütsüleme Kiti Smoking Kit	230x355x120	5.2	0.01	0.15	

TEKNİK ÖZELLİKLER

- 230V 50 Hz çalışma gücü.
- LPG ve NG ile çalışabilme özelliği.
- Pişirme sırasında enerji sarfiyatını düşüren ECO fonksiyonu.
- PLUS ekstra güç fonksiyonu (gaz).
- SC2 yarı otomatik yıkama.
- 99 programlı pişirme hafızası : 4 fazlı; 3 ısıtma, 4 düşük dereceli pişirme ve 1 delta T programı.
- Tek noktalı pişirme probu.
- UR2 pişirme esnasında otomatik nem kontrolü.
- RDC ekonomik buhar jenerasyonu sistemi.
- Ters yönlü 2 kademeli AWC fan.
- Manuel buhar enjeksiyonu.
- Alarmla uyarı verebilen arıza teşhis özelliği.
- IPX5 koruma derecesi.
- Çift temperli camlı kapı.
- 304 kalite paslanmaz dış gövde, 316 kalite fırın iç yapısı.
- Kapalı kapı ile fırın içi soğutma fonksiyonu.
- Set edilen ve ölçülen sıcaklık değerlerini ayrı ayrı gösterebilme özelliği.
- Düşük sıcaklıklı veya yüksek sıcaklıklı buhar üretebilme özelliği.
- Kendi kendini yıkayabilme özelliği.

TECHNICAL SPECIFICATIONS

- 230V 50 Hz operation power.
- Lpg or Natural Gas.
- ECO function for consumption reduction in cooking.
- PLUS extra power function (gas).
- SC2 semi automatic washing.
- Cooking modes: manual or programmable selection, 99 programs with 4 phases of whom 7 are standard, 3 re-heating programs, 5 smoking, 4 Low Temperature and 1 Delta T.
- Single-point temperature core probe.
- UR2 automatic humidity control while cooking.
- RDC steam generator with low management cost.
- Automatic fan reverse AWC, 2 fan speeds.
- Manual steam injection.
- Self-diagnosis with malfunction alarms.
- IPX5 protection degree.
- Door double tempered glazing.
- AISI 304 stainless steel polished cooking chamber, with AISI 316L (1,2 mm) top and bottom and rounded edges without joints.
- Automatic Cooling and Preheating.
- Display of set and current cooking values.
- Low temperature steam and Superheated steam.
- Self cleaning system.



Tütsüleme Kiti
Smoker Kit

Tüm modellerde tepsi kitleri fiyata dahildir.
Tray kits are included in the price for each model.

Fırınlar Ovens

Elektrikli Kombi Fırınlar Electrical Combi Ovens

andora



Kod Code	Ürün Adı Description	Ebatlar Dimension	Ağırlık Weight	Net Net	Güç Power	Kapasite Capacity
		a x b x c (mm)	(kg)	(m ³)	(kw)	(gn)
ANDCBE6	Elektrikli Kombi Fırın Electrical Combi Oven	920x874x730	160	1	10.1	6x(1/1 Gn)
ANDCBE10	Elektrikli Kombi Fırın Electrical Combi Oven	920x874x975	198	1.2	17.3	10x(1/1 Gn)
ANDCBE6-AS	Fırın Alt Standı Oven Bottom Stand	740x850x700	25	0.45		
ANDCBE10-AS	Fırın Alt Standı Oven Bottom Stand	700x860x600	30	0.3		
ANDTTK01	Tütsüleme Kiti Smoking Kit	230x355x120	5.2	0.01	0.15	

TEKNİK ÖZELLİKLER

- 400 V. 50 Hz çalışma gücü.
- Pişirme sırasında enerji sarfiyatını düşüren ECO fonksiyonu.
- SC2 yarı otomatik yıkama.
- 99 programlı pişirme hafızası : 4 fazlı; 3 ısıtma, 4 düşük dereceli pişirme ve 1 delta T programı.
- Tek noktalı pişirme probu.
- UR2 pişirme esnasında otomatik nem kontrolü.
- RDC ekonomik buhar jenerasyonu sistemi.
- Ters yönlü 2 kademeli AWC fan.
- Dijital kontrol.
- Manuel buhar enjeksiyonu.
- Alarmla uyarı verebilen arıza teşhis özelliği.
- IPX5 koruma derecesi.
- Çift temperli camlı kapı.
- 304 kalite paslanmaz dış gövde, 316 kalite fırın iç yapısı.
- Ergonomik kapı kulbu.
- Kapalı kapı ile fırın içi soğutma fonksiyonu.
- Pişirme başlangıç saatini ayarlayabilme özelliği.
- Set edilen ve ölçülen sıcaklık değerlerini ayrı ayrı gösterebilme özelliği.
- Düşük sıcaklıklı veya yüksek sıcaklıklı buhar üretebilme özelliği.
- Kendi kendini yıkayabilme özelliği.

TECHNICAL SPECIFICATIONS

- 400 V. 50 Hz operation power.
- ECO function for consumption reduction in cooking.
- SC2 semi automatic washing.
- Cooking modes: manual or programmable selection, 99 programs with 4 phases of whom 7 are standard, 3 re-heating programs, 5 smoking, 4 Low Temperature and 1 Delta T.
- Single-point temperature core probe.
- UR2 automatic humidity control while cooking.
- RDC steam generator with low management cost.
- Automatic fan reverse AWC, 2 fan speeds.
- Digital controls.
- Manual steam injection.
- Self-diagnosis with malfunction alarms.
- IPX5 protection degree.
- Door double tempered glazing.
- AISI 304 stainless steel polished cooking chamber ,with AISI 316L (1,2 mm) top and bottom and rounded edges without joints.
- Handle with double handgrip, easier opening also with hands full.
- Automatic Cooling and Preheating.
- Start-up time selection.
- Display of set and current cooking values.
- Low temperature steam and Superheated steam.
- Self cleaning system.



Tütsüleme Kiti
Smoker Kit

Tüm modellerde tepsi kitleri fiyata dahildir.
Tray kits are included in the price for each model.



Kod Code	Ürün Adı Description	Ebatlar Dimension	Ağırlık Weight	Net Net	Güç Power	Kapasite Capacity
		a x b x c (mm)	(kg)	(m³)	(kw)	(gn)
ANDCBE24	Elektrikli Kombi Fırın Electrical Combi Oven	1178x1064x1190	278	2.9	27.5	12x(2/1 Gn)
ANDCBE40	Elektrikli Kombi Fırın Electrical Combi Oven	1190x1074x1795	449	3.4	55.5	40x(1/1 Gn)
ANDCBE24-AS	Fırın Alt Standı Oven Bottom Stand	1210x860x600	32	0.6		
ANDCBG40.TA-16	Tepsi Arabası ve Tepsi Kiti Tray Trolley and Tray Kit	590x750x1700	77	1.5		15x(40x60) tepsi/tray
ANDCBG40.TA-20	Tepsi Arabası ve Tepsi Kiti Tray Trolley and Tray Kit	820x920x1710	77	1.5		20x(2/1 Gn)
ANDTTK01	Tütsüleme Kiti Smoking Kit	230x355x120	5.2	0.01	0.15	

TEKNİK ÖZELLİKLER

- 400 V. 50 Hz çalışma gücü.
- Pişirme sırasında enerji sarfiyatını düşüren ECO fonksiyonu.
- SC2 yarı otomatik yıkama.
- 99 programlı pişirme hafızası : 4 fazlı; 3 ısıtma, 4 düşük dereceli pişirme ve 1 delta T programı.
- Tek noktalı pişirme probu.
- UR2 pişirme esnasında otomatik nem kontrolü.
- RDC ekonomik buhar jenerasyonu sistemi.
- Ters yönlü 2 kademeli AWC fan.
- Dijital kontrol.
- Manuel buhar enjeksiyonu.
- Alarmla uyarı verebilen arıza teşhis özelliği.
- IPX5 koruma derecesi.
- Çift temperli camlı kapı.
- 304 kalite paslanmaz dış gövde, 316 kalite fırın iç yapısı.
- Ergonomik kapı kulbu.
- Kapalı kapı ile fırın içi soğutma fonksiyonu.
- Pişirme başlangıç saatini ayarlayabilme özelliği.
- Set edilen ve ölçülen sıcaklık değerlerini ayrı ayrı gösterebilme özelliği.
- Düşük sıcaklıklı veya yüksek sıcaklıklı buhar üretebilme özelliği.
- Kendi kendini yıkayabilme özelliği.

TECHNICAL SPECIFICATIONS

- 400 V. 50 Hz operation power.
- ECO function for consumption reduction in cooking.
- SC2 semi automatic washing.
- Cooking modes: manual or programmable selection, 99 programs with 4 phases of whom 7 are standard, 3 re-heating programs, 5 smoking, 4 Low Temperature and 1 Delta T.
- Single-point temperature core probe.
- UR2 automatic humidity control while cooking.
- RDC steam generator with low management cost.
- Automatic fan reverse AWC, 2 fan speeds.
- Digital controls.
- Manual steam injection.
- Self-diagnosis with malfunction alarms.
- IPX5 protection degree.
- Door double tempered glazing.
- AISI 304 stainless steel polished cooking chamber ,with AISI 316L (1,2 mm) top and bottom and rounded edges without joints.
- Handle with double handgrip, easier opening also with hands full.
- Automatic Cooling and Preheating.
- Start-up time selection.
- Display of set and current cooking values.
- Low temperature steam and Superheated steam.
- Self cleaning system.



Tütsüleme Kiti
Smoker Kit

Tüm modellerde tepsi kitleri fiyata dahildir.
Tray kits are included in the price for each model.



Kod Code	Ürün Adı Description	Ebatlar Dimension	Ağırlık Weight	Net Net	Güç Power	Kapasite Capacity
		a x b x c (mm)	(kg)	(m ³)	(kw)	(gn)
AND.APFE423-U	Mini Konveksiyonlu Fırın Üstten Açılır Mini Convection Oven Top Opening	512x738x559	45	0.21	3	4x2/3 Gn
AND.APFE423-Y	Mini Konveksiyonlu Fırın Yana Açılır Mini Convection Oven Side Opening	512x748x574	54	0.22	3	4x2/3 Gn

TEKNİK ÖZELLİKLER

- 0/300 °C arasında ayarlanabilir pişirme sıcaklığı.
- Tek yöne dönümlü fan.
- Ayarlanabilir pişirme süresi.
- Termostat kontrollü.
- Silikon contalı temperlenmiş cam.
- Sensörlü kapı sistemi.
- Paslanmaz çelik gövde.

AND.APFE423-U

- Üstten açılır kapak sistemi.

AND.APFE423-Y

- Yandan açılır kapak sistemi.

AND.APFE423-U

- Elektrik Girişi: 230V AC N PE
- Kablo Kesiti (mm²): 3x1,5

AND.APFE423-Y

- Elektrik Girişi: 230V AC N PE
- Kablo Kesiti (mm²): 3x2,5

TECHNICAL SPECIFICATIONS

- Adjustable cooking temperature between 0/300 °C
- Single direction fan.
- Adjustable cooking time.
- Thermostat control.
- Silicone sealed tempered glass.
- Switch system on the door.
- Stainless steel body.

AND.APFE423-U

- Top opening cover system.

AND.APFE423-Y

- Side opening cover system.

AND.APFE423-U

- Electric Input: 230V AC N PE
- Cable Cross Section (mm²): 3x1,5

AND.APFE423-Y

- Electric Input: 230V AC N PE
- Cable Cross Section (mm²): 3x2,5



Kod Code	Ürün Adı Description	Ebatlar Dimension	Ağırlık Weight	Net Net	Güç Power	Kapasite Capacity
		a x b x c (mm)	(kg)	(m ³)	(kw)	(tray)
AND.APFE4-U	Konveksiyonlu Patisserie Fırını Üstten Açılır Convection Patisserie Oven Top Opening	802x856x587	90	0.40	7	4-40x60
AND.APFE4-Y	Konveksiyonlu Patisserie Fırını Yana Açılır Convection Patisserie Oven Side Opening	802x864x502	94	0.35	7	4-40x60
AND.APFE6-Y	Konveksiyonlu Patisserie Fırını Yana Açılır Convection Patisserie Oven Side Opening	802x855x737	106	0.50	10	6-40x60
AND.AMF4-6	Mayalandırma Kabini Fermentation Cabinet	800x792x865	46	0.55	3.2	8-40x60

TEKNİK ÖZELLİKLER

- 0/300 °C arasında ayarlanabilir pişirme sıcaklığı.
- Çift yöne dönebilen fan ile eşit ısı dağılımı.
- Ayarlanabilir dijital pişirme süresi.
- Dijital sıcaklık göstergesi.
- Manuel buhar verme.
- Silikon contalı temperlenmiş cam.
- Sensörlü kapı sistemi.
- Paslanmaz çelik gövde.

AND.AMF4-6

- 0-90 °C çalışma aralığı.
- Nemlendirme sistemi.

TECHNICAL SPECIFICATIONS

- Adjustable cooking temperature between 0/300 °C
- Dual direction fan provides homogenous heat distribution.
- Adjustable digital cooking time.
- Digital temperature display.
- Manuel steam.
- Silicone sealed tempered glass.
- Switch system on the door.
- Stainless steel body.

AND.AMF4-6

- 0-90 °C operating temperatur.
- Humidification system



AND.APFE4-U / AND.APFE4-Y

- Elektrik Girişi: 230V AC N PE
- Kablo Kesiti (mm²): 5x2,5

AND.APFE6-Y

- Elektrik Girişi: 400V AC 3N PE
- Kablo Kesiti (mm²): 5x2,5

AND.AMF4-6

- Elektrik Girişi: 230V AC N PE
- Kablo Kesiti (mm²): 5x2,5

AND.APFE4-U / AND.APFE4-Y

- Electric Input: 230V AC N PE
- Cable Cross Section (mm²): 5x2,5

AND.APFE6-Y

- Electric Input: 400V AC 3N PE
- Cable Cross Section (mm²): 5x2,5

AND.AMF4-6

- Electric Input: 230V AC N PE
- Cable Cross Section (mm²): 5x2,5



Kod Code	Ürün Adı Description	Ebatlar Dimension	Ağırlık Weight	Net Net	Güç Power	Kapasite Capacity
		a x b x c (mm)	(kg)	(m ³)	(kw)	(tray)
AND.APFG8	Gazlı Plus Konveksiyonlu Patisserie Fırını Gas Plus Convection Patisserie Oven	1045x1043x1312	181	1.43	35	8-40x60
AND.AMF8	Mayalandırma Kabini Fermantation Cabinet	1030x797x834	64	0.69	2.5	8-40x60
AND.AAS8	Fırın Alt Standı Oven Bottom Stand	1060x910x641	24	0.62		

TEKNİK ÖZELLİKLER

- Manuel nemlendirme özelliği.
- Ayarlanabilir pişirme süresi ve dijital göstergesi.
- 0/300 °C arasında ayarlanabilir pişirme sıcaklığı.
- 360 °C lik limit termostat.
- Paslanmaz çelik kapalı sistem ısı transfer boruları.
- Lpg ve Ng ile çalışabilme özelliği.
- Çift yöne dönebilen fan ile eşit ısı dağılımı.
- Silikon contalı temperlenmiş cam.
- Kolay temizlik imkanı sağlayan açılabilir iç cam.
- Sensörlü kapı sistemi.
- Paslanmaz çelik gövde.

AND.AMF8

- 0-90 °C çalışma aralığı.
- Nemlendirme sistemi.

AND.APFG8

- Gaz Tüketim Değeri (ng): 3,70 m³/h
- Gaz Tüketim Değeri (lpg): 2,74 kg/h

AND.AMF8

- Elektrik Girişi: 230V AC N PE
- Kablo Kesiti: 3x2,5

TECHNICAL SPECIFICATIONS

- Manual steamer.
- Adjustable cooking time and digital temperature display.
- Adjustable cooking temperature between 0/300 °C
- Safety thermostat for overheating protection (360 °C).
- Stainless steel heat exchanger sealed system pipes.
- Lpg or Natural Gas.
- Dual direction fan provides homogenous heat distribution.
- Silicone sealed tempered glass.
- Easy-access interior glass in order to provide cleaning.
- Door switch system.
- Stainless steel body.

AND.AMF8

- 0-90 °C operating temperatur.
- Humitication system

AND.APFG8

- Gas Consumption (ng): 3,70 m³/h
- Gas Consumption (lpg): 2,74 kg/h

AND.AMF8

- Electric Input: 230V AC N PE
- Cable Cross Section: 3x2,5



Kod Code	Ürün Adı Description	Ebatlar Dimension a x b x c (mm)	Ağırlık Weight (kg)	Net Net (m ³)	Güç Power (kw)	Kapasite Capacity (tray)
AND.APFE8	Elektrikli Plus Konveksiyonlu Patisserie Fırını Electrical Plus Convection Patisserie Oven	1040x1040x1312	163	1.42	19.5	8-40x60
AND.AMF8	Mayalandırma Kabini Fermentation Cabinet	1030x797x834	64	0.69	2.5	8-40x60
AND.AAS8	Fırın Alt Standı Oven Bottom Stand	1060x910x641	24	0.62		

TEKNİK ÖZELLİKLER

- Manuel nemlendirme özelliği.
- Ayarlanabilir pişirme süresi ve dijital göstergesi.
- 0/300 °C arasında ayarlanabilir pişirme sıcaklığı.
- 360 °C lik limit termostat.
- Çift yöne dönebilen fan ile eşit ısı dağılımı.
- Silikon contalı temperlenmiş cam.
- Kolay temizlik imkanı sağlayan açılabilir iç cam.
- Sensörlü kapı sistemi.
- Paslanmaz çelik gövde.

AND.AMF8

- 0-90 °C çalışma aralığı.
- Nemlendirme sistemi.

TECHNICAL SPECIFICATIONS

- Manual steamer.
- Adjustable cooking time and digital temperature display.
- Adjustable cooking temperature between 0/300 °C
- Safety thermostat for overheating protection (360 °C).
- Dual direction fan provides homogenous heat distribution.
- Silicone sealed tempered glass.
- Easy-access interior glass in order to provide cleaning.
- Door switch system.
- Stainless steel body.

AND.AMF8

- 0-90 °C operating temperatur.
- Humitication system

AND.APFE8

- Elektrik Girişi: 400V AC 3N PE
- Kablo Kesiti (mm²): 5x6

AND.AMF8

- Elektrik Girişi: 230V AC N PE
- Kablo Kesiti (mm²): 3x2,5

AND.APFE8

- Electric Input: 400V AC 3N PE
- Cable Cross Section (mm²): 5x6

AND.AMF8

- Electric Input: 230V AC N PE
- Cable Cross Section (mm²): 3x2,5



Kod Code	Ürün Adı Description	Ebatlar Dimension	Ağırlık Weight	Net Net	Güç Power
		a x b x c (mm)	(kg)	(m ³)	(kw)
AND.APFE.4+5-Y-B	Elektrikli Kombi Fırın Büyük Model Electrical Combi Oven Big Model	1043x1051x1203	196	1.32	14.5
AND.AMF8-B	Mayalandırma Kabini Fermantation Cabinet	1030x987x834	64	0.69	2.5
AND.APFE.4+5-Y-K	Elektrikli Kombi Fırın Küçük Model Electrical Combi Oven Small Model	1043x961x1203	172	1.20	13
AND.AMF8-K	Mayalandırma Kabini Fermantation Cabinet	1030x797x834	56	0.69	2.5

TEKNİK ÖZELLİKLER

- Termostatik sıcaklık kontrol ayarı.
- Çift yöne dönebilen fan ile eşit ısı dağılımı.
- Silikon contalı temperlenmiş cam.
- Manuel buhar verme.
- Sensörlü kapı sistemi.
- Dijital iç sıcaklık göstergesi.
- Paslanmaz çelik gövde.

AND.APFE.4+5-Y-B

- Konveksiyonlu fırın kapasite; 400x600 mm 4 tepsi
- Kapasite; pizza fırını için 400x600 mm 2 tepsi.
- Ø 250 mm'lik 6 adet pizza kapasitesi.

AND.APFE.4+5-Y-K

- Konveksiyonlu fırın kapasite; 400x600 mm 4 tepsi.
- Kapasite; pizza fırını için 400x600 mm 1 tepsi.
- Ø 250 mm'lik 5 adet pizza kapasitesi.

AND.AMF8-K

- Kapasite; 8 adet 40x60 Tepsi
- 0-90 °C çalışma aralığı.
- Nemlendirme sistemi.

AND.APFE.4+5-Y-B / AND.APFE.4+5-Y-K

- Elektrik Girişi: 400V AC 3N PE
- Kablo Kesiti (mm²): 5x4

AND.AMF8-B / AND.AMF8-K

- Elektrik Girişi: 230V AC N PE
- Kablo Kesiti (mm²): 3x1,5

TECHNICAL SPECIFICATIONS

- Thermostatic electronic heating control setting.
- Dual direction fan provides homogenous heat distribution.
- Silicon sealed tempered glass.
- Manuel steam.
- Switch system on the door.
- Digital interior temperature indicator.
- Stainless steel body.

AND.APFE.4+5-Y-B

- Convection oven capacity; 400x600 mm 4 trays
- Pizza oven capacity; 400x600 mm 2 trays
- Pizza capacity; 6 pieces Ø 250 mm

AND.APFE.4+5-Y-K

- Convection oven capacity; 400x600 mm 4 trays
- Pizza oven capacity; 400x600 mm 1 tray
- Pizza capacity; 5 pieces Ø 250 mm

AND.AMF8-K

- Capacity; 8 pieces 40x60 tray
- 0-90 °C operating temperatur.

AND.APFE.4+5-Y-B / AND.APFE.4+5-Y-K

- Electric Input: 400V AC 3N PE
- Cable Cross Section (mm²): 5x4

AND.AMF8-B / AND.AMF8-K

- Electric Input: 230V AC N PE
- Cable Cross Section (mm²): 3x1,5

Touch Screen

Buhar jeneratörü standarttır.
Steam generator is standard.

Kod Code	Ürün Adı Description	Ebatlar Dimension	İç Ebatlar Interior Dimensions	Ağırlık Weight	Net Net	Güç Power
		a x b x c (mm)	a x b x c (mm)	(kg)	(m ³)	(kw)
AND.35A45-6	Elektrikli Modüler Fırın Tek Katlı Electrical Modular Oven Single Layer	1651x1446x439	1234x915x339	339	1.049	12
AND.35A45-6D	Fırın Davlumbazı Oven Hood	1718x1464x373		33	0.93	
AND.35A45-6M	Mayalandırma Kabini Fermentation Cabinet	1718x1280x1006		180	2.21	2
AND.35A45-6S	Elektrikli Modüler Fırın Alt Stand Modular Oven Bottom Stand	1720x1280x875		78	1.93	
AND.35A45-6A	Fırın Ara Kat Oven Middle Layer	1720x1280x300		23	0.66	

TEKNİK ÖZELLİKLER
AND.35A45-6

- 7 inç renkli LCD ekran kontrol paneli.
- 99 ayrı program özelliği.
- Manuel veya otomatik nemlendirme özelliği.
- Ekran üzerinden menü kontrol sistemi.
- 0/300 °C arasında ayarlanabilir pişirme sıcaklığı ve dijital göstergesi.
- 350x450 mm'lik 6 tepsi veya 400x600 mm'lik 4 tepsilili fırın kapasitesi.
- 1225 mm x 920 mm fırın iç ölçüsü.
- Ayarlanabilir alt ve üst ısı sıcaklıkları.
- Eşit ısı dağılımı.
- Porselen rezistans.

AND.35A45-6M

- 2x5 bölmeli. (400 mm x 600 mm)
- Ayrı ayrı ayarlanabilir ısı ve nem seviyeleri.

AND.35A45-6

- Elektrik Girişi: 400V AC 3N PE
- Kablo Kesiti (mm²): 5x2,5

AND.35A45-6M

- Elektrik Girişi: 230V AC N PE
- Kablo Kesiti (mm²): 3x2,5

TECHNICAL SPECIFICATIONS
AND.35A45-6

- 7 inch touch screen LCD control panel.
- 99 different cooking programme.
- Manual and automatic steamer.
- On-screen menu control system.
- Adjustable cooking temperature between 0/300 °C
- Capacity. 6 no's of 350x450 mm trays or 4 no's of 400x600 mm trays .
- Interior dimension:1225 mm x 920 mm
- Adjustable top and bottom heating output.
- Homogenous heat distribution.
- Porcelain resistance.

AND.35A45-6M

- 2x5 layers. (400 mm x 600 mm)
- Adjustable temperature and humidity levels.

AND.35A45-6

- Electric Input: 400V AC 3N PE
- Cable Cross Section (mm²): 5x2,5

AND.35A45-6M

- Electric Input: 230V AC N PE
- Cable Cross Section (mm²): 3x2,5

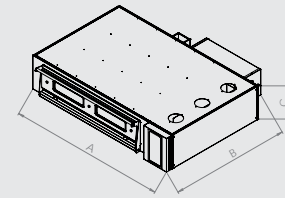
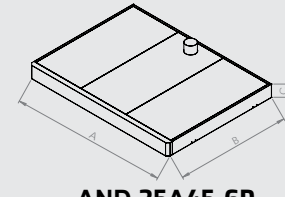
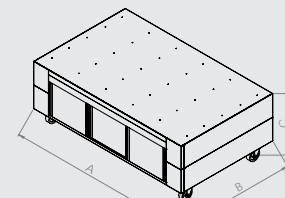
AND.35A45-6

AND.35A45-6D

AND.35A45-6M

İsteğe göre tek, iki veya üç kat yapılabilir.
According to demand single, double or triple layer options.



Kod Code	Ürün Adı Description	Ebatlar Dimension	Ağırlık Weight	Net Net	Güç Power	Kapasite Capacity
		a x b x c (mm)	(kg)	(m ³)	(kw)	(tray)
AND.AEDKF-10	Paslanmaz Döner Konveksiyonlu Fırın Stainless Steel Convection Rotary Oven	990x1160x2254	427	2.58	26.5	10x(40x60)
AND.AEDKF-10-B	Döner Konveksiyonlu Fırın Boyalı Panel Convection Rotary Oven Painted Panel	990x1160x2254	427	2.58	26.5	10x(40x60)

TEKNİK ÖZELLİKLER

- 7 inç renkli LCD ekran kontrol paneli.
- 10x(40x60) tava kapasitesi.
- Ayarlanabilir pişirme süresi.
- Ayarlanabilir pişirme sıcaklığı ve dijital göstergesi, 360 °C lik limit termostat.
- Dönerli sistem sayesinde tüm tavalarda ve tavalarn her bölgesinde eşit pişirme imkanı.
- Ayarlanabilir hava kanalları ile eşit ısı kanalları.
- Kaset sistemi ile yüksek yoğunlukta buhar elde edebilme imkanı.
- Yüksek verimli elektrik rezistansları ile minimum maliyetli pişirme.
- Halojenli aydınlatma özelliği
- Standart fermantasyon kabini ve davlumbaz.
- Kolay temizlik imkanı sağlayan açılabilir iç cam.
- Sensörlü kapı sistemi.
- Paslanmaz çelik gövde.

MAYALANDIRMA KABİNİ

- 12x(40x60) tava kapasitesi.
- 4 kW elektrik gücü.
- Paslanmaz çelik gövde.

AND.AEDKF-10 / AND.AEDKF-10-B

- Elektrik Girişi: 400V AC 3N PE
- Kablo Kesiti (mm²): 5x6

TECHNICAL SPECIFICATIONS

- 7 inch touch screen LCD control panel.
- 10x(40x60) tray capacity.
- Adjustable cooking time.
- Adjustable cooking temperature between 0/300 °C
- Safety thermostat for overheating protection 360 °C
- Provide homogenic cooking due to rotary system.
- Homogenic heating due to adjustable air system.
- Cassette system provides high density evaporation.
- Due to high efficiency resistance.
- Halogenic lighting.
- Equipped with proofing cabinet and hood.
- Easy-access interior glass in order to provide cleaning.
- Door switch system.
- Stainless steel body.

FERMENTATION CABINET

- 12x(40x60) tray capacity.
- 4 kW electric power.
- Stainless steel body.

AND.AEDKF-10 / AND.AEDKF-10-B

- Electric Input: 400V AC 3N PE
- Cable Cross Section (mm²): 5x6

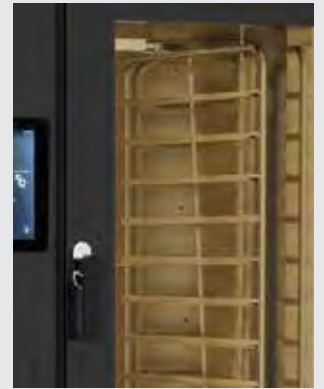



Touch Screen



Kod Code	Ürün Adı Description	Ebatlar Dimension	Ağırlık Weight	Net Net	Güç Power	Kapasite Capacity
		a x b x c (mm)	(kg)	(m ³)	(kw)	(tray)
AND.AGDKF-10	Paslanmaz Döner Konveksiyonlu Fırın Stainless Steel Convection Rotary Oven	990x1160x2254	427	2.58	46.43	10x(40x60)
AND.AGDKF-10-B	Döner Konveksiyonlu Fırın Boyalı Panel Convection Rotary Oven Painted Panel	990x1160x2254	427	2.58	46.43	10x(40x60)

TEKNİK ÖZELLİKLER

- 7 inç renkli LCD ekran kontrol paneli.
- LPG ve Doğalgaz ile çalışabilme özelliği.
- 10x(40x60) tava kapasitesi.
- Ayarlanabilir pişirme süresi.
- 0/300 °C arasında ayarlanabilir pişirme sıcaklığı ve dijital göstergesi, 360 °C lik limit termostat.
- Dönerli sistem sayesinde tüm tavalarda ve tavaların her bölgesinde eşit pişirme imkanı.
- Ayarlanabilir hava kanalları ile eşit ısı kanalları.
- Kaset sistemi ile yüksek yoğunlukta buhar elde edebilme imkanı.
- Yüksek verimli elektrik rezistansları ile minimum maliyetli pişirme.
- Halojenli aydınlatma özelliği
- Standart fermantasyon kabini ve davlumbaz.
- Kolay temizlik imkanı sağlayan açılabilir iç cam.
- Sensörlü kapı sistemi.
- Paslanmaz çelik gövde.

MAYALANDIRMA KABİNİ

- 12x(40x60) tava kapasitesi.
- 4 kW elektrik gücü.
- Paslanmaz çelik gövde.

AND.AGDKF-10 / AND.AGDKF-10-B

- Gaz Tüketim Değeri (ng): 4,90 m³/h
- Gaz Tüketim Değeri (lpg): 3,65 kg/h

TECHNICAL SPECIFICATIONS

- 7 inch touch screen LCD control panel.
- LPG or Natural gas.
- 10x(40x60) tray capacity.
- Adjustable cooking time.
- Adjustable cooking temperature between 0/300 °C
- Safety thermostat for overheating protection 360 °C
- Provide homogenic cooking due to rotary system.
- Homogenic heating due to adjustable air system.
- Cassette system provides high density evaporation.
- Due to high efficiency resistance.
- Halogenic lighting.
- Equipped with proofing cabinet and hood.
- Easy-access interior glass in order to provide cleaning.
- Door switch system.
- Stainless steel body.

FERMENTATION CABINET

- 12x(40x60) tray capacity.
- 4 kW electric power.
- Stainless steel body.

AND.AGDKF-10 / AND.AGDKF-10-B

- Gas Consumption (ng): 4,90 m³/h
- Gas Consumption (lpg): 3,65 kg/h





Kod Code	Ürün Adı Description	Ebatlar Dimension	Ağırlık Weight	Net Net	Güç Power	Kapasite Capacity
		a x b x c (mm)	(kg)	(m ³)	(kw)	(tray)
AND.AMF.20	Mayalandırma Kabini Tek Cidarlı Fermentation Cabinet Single Jacket	500x720x1800	78	0.7	4	16x(40x60)
AND.AMF.20-T	Mayalandırma Kabini Tekerlekli Tek Cidarlı Fermentation Cabinet With Wheel Single Jacket	500x720x1800	80	0.7	4	16x(40x60)
AND.AMFI.20	Mayalandırma Kabini İzolasyonlu Fermentation Cabinet Isolated	630x850x1900	104	1.02	4	16x(40x60)
AND.AMFI.20-T	Mayalandırma Kabini Tekerlekli İzolasyonlu Fermentation Cabinet With Wheel Isolated	630x850x1900	106	1.02	4	16x(40x60)

TEKNİK ÖZELLİKLER

- 0/90 °C çalışma ısısı.
- 16x(40x60) tepsi kapasitesi.
- Termostatik sıcaklık kontrol ayarı.
- Buhar Rezistansı.
- Paslanmaz çelik gövde.

AND.AMFI.20 / AND.AMFI.20-T

- İzolasyonlu kabinler için; 40 kg/m³ yoğunluk.

AND.AMF.20 / AND.AMF.20-T

- Elektrik Girişi: 230V AC N PE
- Kablo Kesiti (mm²): 3x1,5

AND.AMFI.20 / AND.AMFI.20-T

- Elektrik Girişi: 230V AC N PE
- Kablo Kesiti (mm²): 3x1,5

TECHNICAL SPECIFICATIONS

- 0/90 °C operating temperature.
- 16x(40x60) tray capacity.
- Thermostatic electronic heating control setting.
- Steam resistance.
- Stainless steel body.

AND.AMFI.20 / AND.AMFI.20-T

- For Isolated cabinet; 40 kg/m³ density.

AND.AMF.20 / AND.AMF.20-T

- Electric Input: 230V AC N PE
- Cable Cross Section (mm²): 3x1,5

AND.AMFI.20 / AND.AMFI.20-T

- Electric Input: 230V AC N PE
- Cable Cross Section (mm²): 3x1,5



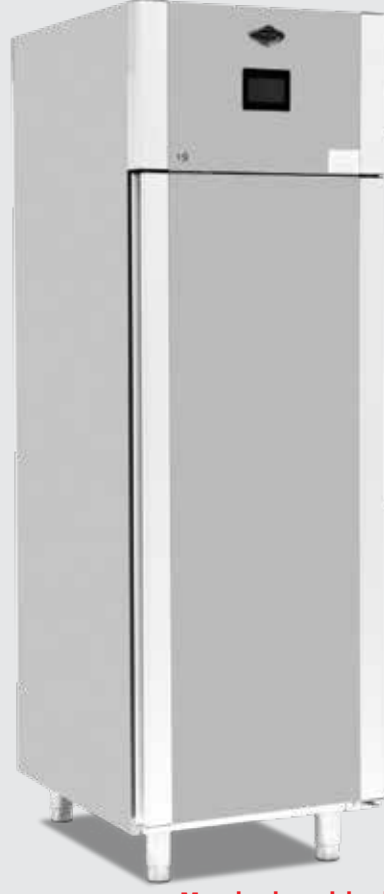

Mayalandırma işlemi bittikten sonra istenilen sıcaklıkta sabit tutabilme özelliği.
Ability to keep it constant at the desired temperature after the fermentation process is finished.

Kod Code	Ürün Adı Description	Ebatlar Dimension	Ağırlık Weight	Net Net	Güç Power
		a x b x c (mm)	(kg)	(m ³)	(kw)
AND.A70.95.01-FR	Otomatik Programlı Fermantasyon Dolabı (Sıcak-Soğuk) Automatic Programmed Retarder Proofer (Hot-Cold)	700x800x2050	163	1.2	0.69

TEKNİK ÖZELLİKLER

- Kapasite: 20 adet (40x60) tepsi.
- Çalışma aralığı -18/+80 °C
- Tek başına soğutucu olarak kullanabilme.
- Tek başına mayalandırma dolabı olarak kullanabilme.
- Tek başına belirli süreye kadar soğuk, sonrasında mayalandırma dolabı olarak kullanabilme.
- 220V - 230V -1 +N 50-60 Hz elektrik gücü.
- R290 soğutucu gaz.
- 40 kg/m³ yoğunluk.
- Elektronik sıcaklık ve defrost kontrollü gösterge.
- Defrost esnasında otomatik su buharlaştırma.
- Sökülebilir havalandırılmalı kompresör.
- Fanlı Soğutma.
- Paslanmaz çelik gövde.

Otomatik fermantasyon elektronik kontrolü

1. Faz; fermantasyonu durdurma süreci maksimum 7 gün.
2. Faz; 72 saate kadar muhafaza.
3. Faz; fermantasyon sürecini yeniden başlatma.
4. Faz; sıcaklık kontrollü fermantasyon ve nemlendirme.
5. Faz; nemlendirme sonrası ürün muhafazası (kullanılan ürüne göre 5-10 saat)

TECHNICAL SPECIFICATIONS

- Capacity: 20 pieces (40x60) tray.
- Operating range -18/+80 °C
- Ability to use as a only cooler.
- Ability to use as a only fermentation cabinet.
- To be able to use it as a cold only for a certain time and then as a fermentation cabinet.
- 220V - 230V -1 +N 50-60 Hz electrical power.
- R290 refrigerant gas.
- Density of 40 kg/m³.
- Electronic temperature and defrost control indicator.
- Automatic evaporation of water during defrosting.
- Detachable ventilated compressor.
- Fan Cooling.
- Stainless steel body.

Automatic fermentation electronic control

- Phase 1; The process of stopping the fermentation is 7 days maximum.
- Phase 2; Storage up to 72 hours.
- Phase 3; restarting the fermentation process.
- Phase 4; temperature controlled fermentation and humidification.
- Phase 5; product storage after moistening (5-10 hours depending on the product used)



Fırınlr Ovens

Gazlı Taş Tabanlı Pizza Fırınlr Gas Stone-Based Pizza Ovens

andora



Renk Seçenekleri Color Options



AND.ASPO.H-60-W - AND.ASPO.H-70-W
Beyaz / White

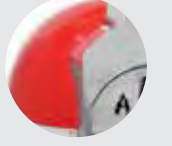

AND.ASPO.H-60-R - AND.ASPO.H-70-R
Kırmızı / Red



AND.ASPO.H-60-B - AND.ASPO.H-70-B
Siyah / Black

*** Lütfen, Siparişlerinizde ürün renk kodunu belirtiniz.**
Please, Specify colour code on order.



Kod Code	Ürün Adı Description	İç Ebatlar Interior Dimensions	Ebatlar Dimension	Ağırlık Weight	Net Net	Güç Power
		a x b x c (mm)	a x b x c (mm)	(kg)	(m ³)	(kw)
AND.ASPO.H-60	Gazlı Taş Tabanlı Pizza Fırını Gas Stone Base Pizza Oven	Ø 600	755x815x1465	114	0.47	11
AND.ASPO.H-70	Gazlı Taş Tabanlı Pizza Fırını Gas Stone Base Pizza Oven	Ø 700	850x920x1450	145	0.65	11
AND.ASPO.H-60-AS	Alt Stand Bottom Stand		710x705x822	26	0.41	
AND.ASPO.H-70-AS	Alt Stand Bottom Stand		780x780x822	29	0.50	

TEKNİK ÖZELLİKLER

- 0/400 °C arasında ayarlanabilir pişirme sıcaklığı.
- 600 mm çapında fırın pişirme taşı.
- 265 mm fırın iç yüksekliği.
- 360x200 mm kapı ölçüsü.
- LPG ve NG ile çalışabilme özelliği.
- Paslanmaz çelik iç hazne.
- Piezzo çakmak ile kontrol.
- Manuel iç sıcaklık göstergesi.
- Emniyet ventilli musluk.

TECHNICAL SPECIFICATIONS

- Adjustable cooking temperature between 0/400 °C
- Internal stone diameter: 600 mm
- Internal high: 265 mm
- Door dimension: 360x200 mm
- Adaptable to LPG or NG.
- Stainless steel internal reservoir.
- Piezo lighter ignition system.
- Manuel interior temperature indicator.
- Magnet safety valve.

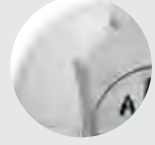

Renk Seçenekleri
Color OptionsAND.ASPO.H-60-W-W - AND.ASPO.H-70-W-W
Beyaz / WhiteAND.ASPO.H-60-W-R - AND.ASPO.H-70-W-R
Kırmızı / RedAND.ASPO.H-60-W-B - AND.ASPO.H-70-W-B
Siyah / Black* Lütfen, Siparişlerinizde ürün
renk kodunu belirtiniz.
Please, Specify colour code on order.

Kod Code	Ürün Adı Description	İç Ebatlar Interior Dimensions	Ebatlar Dimension	Ağırlık Weight	Net Net	Güç Power
		a x b x c (mm)	a x b x c (mm)	(kg)	(m ³)	(kw)
AND.ASPO.H-60-W	Odunlu Taş Tabanlı Pizza Fırını Wood Stone Base Pizza Oven	Ø 600	755x815x1465	114	0.47	11
AND.ASPO.H-70-W	Odunlu Taş Tabanlı Pizza Fırını Wood Stone Base Pizza Oven	Ø 700	850x920x1450	145	0.65	11
AND.ASPO.H-60-AS	Alt Stand Bottom Stand		710x705x822	26	0.41	
AND.ASPO.H-70-AS	Alt Stand Bottom Stand		780x780x822	29	0.50	

TEKNİK ÖZELLİKLER

- 0/400 °C arasında ayarlanabilir pişirme sıcaklığı.
- 600 mm çapında fırın pişirme taşı.
- 265 mm fırın iç yüksekliği.
- 360x200 mm kapı ölçüsü.
- LPG ve NG ile çalışabilme özelliği.
- Paslanmaz çelik iç hazne.
- Piezzo çakmak ile kontrol.
- Manuel iç sıcaklık göstergesi.
- Emniyet ventilli musluk.

TECHNICAL SPECIFICATIONS

- Adjustable cooking temperature between 0/400 °C
- Internal stone diameter: 600 mm
- Internal high: 265 mm
- Door dimension: 360x200 mm
- Adaptable to LPG or NG.
- Stainless steel internal reservoir.
- Piezo lighter ignition system.
- Manuel interior temperature indicator.
- Magnet safety valve.



Fırınlar Ovens

Elektrikli Döner Tabanlı Pizza Fırınları Electrical Rotating Base Pizza Ovens

andora



Ø 300 mm 6 pizza



Döner Tabanlı Taş
Rotary Base Stone



AND.ASPO.01-D



Renk Seçenekleri Color Options



AND.ASPO.01-RB - AND.ASPO.01-D-RB
Kırmızı-Siyah / Red-Black



AND.ASPO.01-RB - AND.ASPO.01-D-GB
Altın-Siyah / Gold-Black

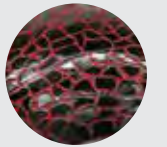

AND.ASPO.01-BR - AND.ASPO.01-D-BR
Siyah-Kırmızı / Black-Red

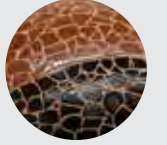

AND.ASPO.01-BB - AND.ASPO.01-D-BB
Kahverengi-Siyah / Brown-Black

Siparişlerinizde ürün renk kodunu belirtiniz.
Specify colour code on order.



Kod Code	Ürün Adı Description	Ebatlar Dimension	Ağırlık Weight	Net Net	Güç Power	Kapasite Capacity
AND.ASPO.01	Elektrikli Döner Tabanlı Pizza Fırını Electrical Rotating Base Pizza Oven	1200x1384x2000	331	3.32	17	Ø 300 mm 6 pizza Ø 75 pizza / saat-hour
AND.ASPO.01-D	Dijital Elektrikli Döner Taban Pizza Fırını Digital Electrical Rotating Base Pizza Oven	1200x1384x2000	331	3.32	17	Ø 300 mm 6 pizza 75 pizza / saat-hour

TEKNİK ÖZELLİKLER

- Ayarlanabilir pişirme süresi ve dijital göstergesi.
- 0/400 °C arasında ayarlanabilir pişirme sıcaklığı.
- 170 mm fırın iç yüksekliği.
- 1000 mm çapında fırın pişirme taşı.
- 500x140 mm kapı ölçüsü.
- Homojen pişirme sağlayan döner refraktör taban taşı.
- Paslanmaz çelik iç hazne.
- Dijital iç sıcaklık göstergesi.

AND.ASPO.01-D

- 7 inç renkli LCD ekran kontrol paneli.

AND.ASPO.01 - AND.ASPO.01-D

- Elektrik Girişi: 400V AC 3N PE
- Kablo Kesiti (mm²): 5x4

TECHNICAL SPECIFICATIONS

- Adjustable cooking time and digital indicator.
- Adjustable cooking temperature between 0/400 °C
- Internal high: 170 mm
- Internal stone diameter: 1000 mm
- Door dimension: 500x140 mm
- Rotating bedplate provides homogeneous cooking refractory material.
- Stainless steel internal reservoir.
- Digital interior temperature indicator.

AND.ASPO.01-D

- 7 inch touch screen LCD control panel.

AND.ASPO.01 - AND.ASPO.01-D

- Electric Input: 400V AC 3N PE
- Cable Cross Section (mm²): 5x4





Ø 300 mm 6 pizza

Döner Tabanlı Taş
Rotary Base Stone

AND.ASPO.04-D

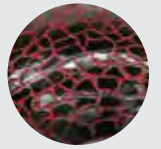
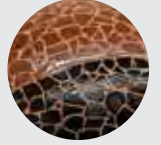
Renk Seçenekleri
Color OptionsAND.ASPO.04-RB - AND.ASPO.04-D-RB
Kırmızı-Siyah / Red-BlackAND.ASPO.04-GB - AND.ASPO.04-D-GB
Altın-Siyah / Gold-BlackAND.ASPO.04-BR - AND.ASPO.04-D-BR
Siyah-Kırmızı / Black-RedAND.ASPO.04-BB - AND.ASPO.04-D-BB
Kahverengi-Siyah / Brown-BlackSiparişlerinizde ürün renk kodunu belirtiniz.
Specify colour code on order.

Kod Code	Ürün Adı Description	Ebatlar Dimension	Ağırlık Weight	Net Net	Güç Power	Kapasite Capacity
		a x b x c (mm)	(kg)	(m ³)	(kw)	
AND.ASPO.04	Gazlı Döner Tabanlı Pizza Fırını Gas Rotating Base Pizza Oven	1480x1724x1855	764	4.73	41.20	Ø 300 mm 6 pizza 75 pizza / saat-hour
AND.ASPO.04-D	Dijital Gazlı Döner Taban Pizza Fırını Digital Gas Rotating Base Pizza Oven	1480x1724x1855	764	4.73	41.20	Ø 300 mm 6 pizza 75 pizza / saat-hour

TEKNİK ÖZELLİKLER

- Ayarlanabilir pişirme süresi ve dijital göstergesi.
- 0-400 °C arasında ayarlanabilir pişirme sıcaklığı.
- 220V 50/60 Hz. Çalışma gücü.
- LPG ve NG ile çalışabilme özelliği.
- Hızlı ve verimli pişirme olanağı sağlayan termal sabitleme.
- Homojen pişirme sağlayan döner refraktör taban taşı.
- 450 mm fırın iç yüksekliği.
- 1000 mm çapında fırın pişirme taşı.
- 500x140 mm kapı ölçüsü.

AND.ASPO.04-D

- 7 inch touch screen LCD control panel.

TECHNICAL SPECIFICATIONS

- Adjustable cooking time and digital indicator.
- Adjustable cooking temperature between 0/400 °C
- 220V 50/60 Hz. Operating power.
- Adaptable to LPG or NG.
- Fast and best cooking process through thermal stability.
- Rotating bedplate provides homogeneous cooking refractory material.
- Internal high: 450 mm
- Internal stone diameter: 1000 mm
- Door dimension: 500x140 mm

AND.ASPO.04-D

- 7 inch touch screen LCD control panel.



AND.ASPO.04 - AND.ASPO.04-D

- Gaz Tüketim Değeri (ng): 4,35 m³/h
- Gaz Tüketim Değeri (lpg): 3,72 kg/h

AND.ASPO.04 - AND.ASPO.04-D

- Gas Consumption (ng): 4,35 m³/h
- Gas Consumption (lpg): 3,72 kg/h

Fırınlar Ovens

Gazlı Döner Tabanlı Pizza Fırınları Gas Rotating Base Pizza Ovens

andora



Odonlu tütsüleme sistemi
Smoker system inside
oven with wood



Ø 300 mm 9 pizza

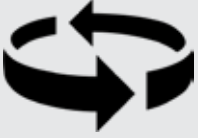

Döner Tabanlı Taş
Rotary Base Stone



AND.ASPO.02-D



Renk Seçenekleri Color Options



AND.ASPO.02-RB - AND.ASPO.02-D-RB
Kırmızı-Siyah / Red-Black



AND.ASPO.02-RB - AND.ASPO.02-D-GB
Altın-Siyah / Gold-Black

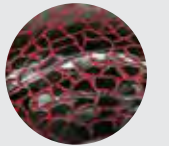

AND.ASPO.02-BR - AND.ASPO.02-D-
BR Siyah-Kırmızı / Black-Red

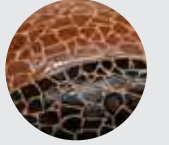

AND.ASPO.02-BB - AND.ASPO.02-D-BB
Kahverengi-Siyah / Brown-Black

Siparişlerinizde ürün renk kodunu belirtiniz.
Specify colour code on order.



Kod Code	Ürün Adı Description	Ebatlar Dimension	Ağırlık Weight	Net Net	Güç Power	Kapasite Capacity
AND.ASPO.02	Gazlı Döner Tabanlı Pizza Fırını Gas Rotating Base Pizza Oven	1965x2127x2113	1500	8.84	48	Ø 300 mm 9 pizza 130 pizza / saat-hour
AND.ASPO.02-D	Dijital Gazlı Döner Taban Pizza Fırını Digital Gas Rotating Base Pizza Oven ⁿ	1965x2127x2113	1500	8.84	48	Ø 300 mm 9 pizza 130 pizza / saat-hour

TEKNİK ÖZELLİKLER

- Ayarlanabilir pişirme süresi ve dijital göstergesi.
- 0/400 °C arasında ayarlanabilir pişirme sıcaklığı.
- 220V 50/60 Hz. Çalışma gücü.
- LPG ve NG ile çalışabilme özelliği.
- Homojen pişirme sağlayan döner refraktör taban taşı.
- 450 mm fırın iç yüksekliği.
- 1200 mm çapında fırın pişirme taşı.
- 500x250 mm kapı ölçüsü.

AND.ASPO.02-D

- 7 inç renkli LCD ekran kontrol paneli.

AND.ASPO.02

- Gaz Tüketim Değeri (ng): 5,07 m³/h
- Gaz Tüketim Değeri (lpg): 4,08 kg/h

TECHNICAL SPECIFICATIONS

- Adjustable cooking time and digital indicator.
- Adjustable cooking temperature between 0/400 °C
- 220V 50/60 Hz. Operating power.
- Adaptable to LPG or NG.
- Rotating bedplate provides homogeneous cooking refractory material.
- Internal high: 450 mm
- Internal stone diameter: 1200 mm
- Door dimension: 500x250 mm

AND.ASPO.02-D

- 7 inch touch screen LCD control panel.

AND.ASPO.02

- Gas Consumption (ng): 5,07 m³/h
- Gas Consumption (lpg): 4,08 kg/h

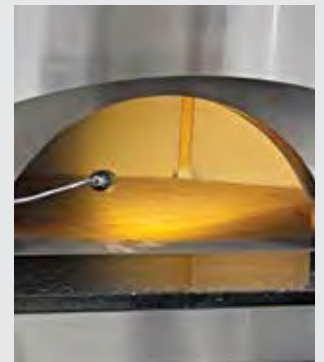



Ø 300 mm 9 pizza



Sabit Tabanlı Taş
Fixed Base Stone



AND.ASP0.03-D



Renk Seçenekleri
Color Options



AND.ASP0.03-RB - AND.ASP0.03-D-RB
Kırmızı-Siyah / Red-Black



AND.ASP0.03-GB - AND.ASP0.03-D-GB
Altın-Siyah / Gold-Black

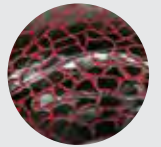

AND.ASP0.03-BR - AND.ASP0.03-D-BR
Siyah-Kırmızı / Black-Red



AND.ASP0.03-BB - AND.ASP0.03-D-BB
Kahverengi-Siyah / Brown-Black

Siparişlerinizde ürün renk kodunu belirtiniz.
Specify colour code on order.



Kod Code	Ürün Adı Description	Ebatlar Dimension	Ağırlık Weight	Net Net	Güç Power	Kapasite Capacity
		a x b x c (mm)	(kg)	(m ³)	(kw)	
AND.ASP0.03	Gazlı Sabit Tabanlı Pizza Fırını Gas Fixed Base Pizza Oven	1480x1724x1855	755	4.74	28.70	Ø 300 mm 9 pizza 130 pizza / saat-hour
AND.ASP0.03-D	Dijital Gazlı Sabit Tabanlı Pizza Fırını Digital Gas Fixed Base Pizza Oven	1480x1724x1855	755	4.74	28.70	Ø 300 mm 9 pizza 130 pizza / saat-hour

TEKNİK ÖZELLİKLER

- Ayarlanabilir pişirme süresi ve dijital göstergesi.
- 0/400 °C arasında ayarlanabilir pişirme sıcaklığı.
- 220V 50/60 Hz. Çalışma gücü.
- LPG ve NG ile çalışabilme özelliği.
- 450 mm fırın iç yüksekliği.
- Termostatik ısıtma.
- 1100x1000 mm Refraktör Pişirme Taşı
- Taş iç hazne.
- Ø 300 mm 9 pizza kapasitesi, saatte 130 pizza.

AND.ASP0.03-D

- 7 inç renkli LCD ekran kontrol paneli.

TECHNICAL SPECIFICATIONS

- Adjustable cooking time and digital indicator.
- Adjustable cooking temperature between 0/400 °C
- 220V 50/60 Hz. Operating power.
- Adaptable to LPG or NG.
- Internal high: 450 mm
- Thermostatic heating.
- 1100x1000 mm refractor stone.
- Stone interior reservoir.
- Pizza capacity:
9 pieces of Ø 300 mm, 130 pizza / hour.

AND.ASP0.03-D

- 7 inch touch screen LCD control panel.



AND.ASP0.03 - AND.ASP0.03-D

- Gaz Tüketim Değeri (ng): 3 m³/h
- Gaz Tüketim Değeri (lpg): 2,73 kg/h

AND.ASP0.03 - AND.ASP0.03-D

- Gas Consumption (ng): 3 m³/h
- Gas Consumption (lpg): 2,73 kg/h

Fırınlar Ovens

Gazlı ve Odunlu Döner Tabanlı Pizza Fırınları Gas and Wood Rotating Pizza Ovens

andora

CE



**Sadece Odunlu
Çalışabilme Özelliği**
Only Adaptable to
operate with wood.



Ø 300 mm 6 pizza

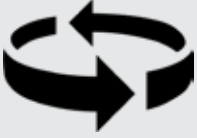

Döner Tabanlı Taş
Rotary Base Stone



AND.ASP0.05-D



Kod Code	Ürün Adı Description	Ebatlar Dimension a x b x c (mm)	Ağırlık Weight (kg)	Net Net (m ³)	Güç Power (kw)	Kapasite Capacity
AND.ASP0.05	Gazlı ve Odunlu Döner Tabanlı Pizza Fırını Gas and Wood Rotating Pizza Oven	1650x1705x1970	865	5.54	41.20	Ø 300 mm 6 pizza 75 pizza/saat-hour
AND.ASP0.05-D	Digital Gazlı ve Odunlu Döner Tabanlı Pizza Fırını Digital Gas and Wood Rotating Pizza Oven	1650x1705x1970	865	5.54	41.20	Ø 300 mm 6 pizza 75 pizza/saat-hour

TEKNİK ÖZELLİKLER

- Ayarlanabilir pişirme süresi ve dijital göstergesi.
- 0/400 °C arasında ayarlanabilir pişirme sıcaklığı.
- 220V 50/60 Hz. Çalışma gücü.
- LPG ve NG ile çalışabilme özelliği.
- Gazlı veya odunlu çalışabilme olanağı.
- 515 mm fırın iç yüksekliği.
- 1000 mm çapında fırın pişirme taşı.
- 650x270 mm kapı ölçüsü.
- Hızlı ve verimli pişirme olanağı sağlayan termal sabitleme olanağı.
- Termostatik ısıtma.
- Homojen pişirme sağlayan döner taban.
- Refraktör pişirme taşı.
- Taş iç hazne.

AND.ASP0.05-D

- 7 inç renkli LCD ekran kontrol paneli.

TECHNICAL SPECIFICATIONS

- Adjustable cooking time and digital indicator.
- Adjustable cooking temperature between 0/400 °C
- 220V 50/60 Hz. Operating power.
- Adaptable to LPG or NG.
- Adaptable to operate with gas or wood.
- Internal high: 515 mm
- Internal stone diameter: 1000 mm
- Door dimension: 650x270 mm
- Fast and best cooking process through thermal stability.
- Thermostatic heating.
- Rotating bedplate provides homogeneous cooking.
- Baking bedplate made by refractory material.
- Stone interior reservoir.

AND.ASP0.05-D

- 7 inch touch screen LCD control panel.

AND.ASP0.05 - AND.ASP0.05-D

- Gaz Tüketim Değeri (ng): 4,35 m³/h
- Gaz Tüketim Değeri (lpg): 3,72 kg/h

AND.ASP0.05 - AND.ASP0.05-D

- Gas Consumption (ng): 4,35 m³/h
- Gas Consumption (lpg): 3,72 kg/h



Renk Seçenekleri
Color OptionsSiyah / Black
AND.APLS.D1-S
AND.APLS.D2-SKırmızı / Red
AND.APLS.D1-K
AND.APLS.D2-KTuruncu / Orange
AND.APLS.D1-T
AND.APLS.D2-TYeşil / Green
AND.APLS.D1-Y
AND.APLS.D2-Y

* Lütfen, Siparişlerinizde ürün renk kodunu belirtiniz.

* Please, Specify colour code on order.



Kod Code	Ürün Adı Description	Ebatlar Dimension	Ağırlık Weight	İç Ebatlar Interior Dimensions	Net Net	Güç Power
		a x b x c (mm)	(kg)	a x b x c (mm)	(m ³)	(kw)
AND.APLS.D1	Gazlı Pizza ve Pide Fırını Gas Pizza Oven	1265x1480x800	260	1000x950	1.50	34
AND.APLS.D2	Gazlı Pizza ve Pide Fırını Gas Pizza Oven	1265x1730x800	299	950x1250	1.75	34
AND.APLF.D1	Alt Stand Bottom Stand	1177x1201x930	66		1.31	
AND.APLF.D2	Alt Stand Bottom Stand	1177x1445x930	74		1.58	

TEKNİK ÖZELLİKLER

- LPG veya NG ile çalışabilme özelliği.
- 0/400 °C arasında ayarlanabilir pişirme derecesi.
- Alt ve üst brülörler birbirinden bağımsız çalışır.
- Musluklar Magnet Emniyet ventillidir.
- Fırın taş tabanlıdır.
- Fırın içi komple paslanmaz çeliktir.
- 4 Farklı renk seçeneği vardır.

TECHNICAL SPECIFICATIONS

- Adaptable LPG or NG
- Adjustable cooking temperature between: 0/400 °C
- Independent top and bottom burners.
- Magnet Safety valves.
- Special stone floor.
- Stainless Steel oven inside.
- 4 different color options.



AND.APLS.D1 / AND.APLS.D2

- Gaz Tüketim Değeri (ng): 3,59 m³/h
- Gaz Tüketim Değeri (lpg): 2,10 kg/h

AND.APLS.D1 / AND.APLS.D2

- Gas Consumption (ng): 3,59 m³/h
- Gas Consumption (lpg): 2,10 kg/h

Renk Seçenekleri
Color OptionsSiyah / Black
AND.APLS.D3-S
AND.APLS.D4-SKırmızı / Red
AND.APLS.D3-K
AND.APLS.D4-KTuruncu / Orange
AND.APLS.D3-T
AND.APLS.D4-TYeşil / Green
AND.APLS.D3-Y
AND.APLS.D4-Y

* Lütfen, Siparişlerinizde ürün renk kodunu belirtiniz.
Please, Specify colour code on order.



Kod Code	Ürün Adı Description	Ebatlar Dimension	Ağırlık Weight	İç Ebatlar Interior Dimensions	Net Net	Güç Power
		a x b x c (mm)	(kg)	a x b x c (mm)	(m ³)	(kw)
AND.APLS.D3	Gazlı Pizza ve Pide Fırını Gas Pizza Oven	1062x1037x800	169	750x600	0.88	30.40
AND.APLS.D4	Gazlı Pizza ve Pide Fırını Gas Pizza Oven	1062x1237x800	194	750x800	1.05	30.40
AND.APLF.D3	Alt Stand Bottom Stand	977x827x930	44		0,75	
AND.APLF.D4	Alt Stand Bottom Stand	977x1027x930	50		0.93	

TEKNİK ÖZELLİKLER

- LPG veya NG ile çalışabilme özelliği.
- 0/400 °C arasında ayarlanabilir pişirme derecesi.
- Alt ve üst brülörler birbirinden bağımsız çalışır.
- Musluklar Magnet Emniyet ventillidir.
- Fırın taş tabanlıdır.
- Fırın içi komple paslanmaz çeliktir.
- 4 Farklı renk seçeneği vardır.

AND.APLS.D3 / AND.APLS.D4

- Gaz Tüketim Değeri (ng): 3,20 m³/h
- Gaz Tüketim Değeri (lpg): 1,48 kg/h

TECHNICAL SPECIFICATIONS

- Adaptable LPG or NG
- Adjustable cooking temperature between: 0/400 °C
- Independent top and bottom burners.
- Magnet Safety valves.
- Special stone floor.
- Stainless Steel oven inside.
- 4 different color options.

AND.APLS.D3 / AND.APLS.D4

- Gas Consumption (ng): 3,20 m³/h
- Gas Consumption (lpg): 1,48 kg/h



Renk Seçenekleri
Color OptionsSiyah / Black
AND.APLS.D5-BKırmızı / Red
AND.APLS.D5-KTuruncu / Orange
AND.APLS.D5-TYeşil / Green
AND.APLS.D5-Y

* Lütfen, Siparişlerinizde ürün
renk kodunu belirtiniz.
Please, Specify colour code on order.



Kod Code	Ürün Adı Description	İç Ebatlar Interior Dimensions	Ebatlar Dimension	Ağırlık Weight	Net Net	Güç Power
		a x b x c (mm)	a x b x c (mm)	(kg)	(m ³)	(kw)
AND.APLS.D5	Gazlı Taş Tabanlı Pizza Fırını Gas Stone Base Pizza Oven	600x600	860x990x1760	117	0.61	11.95
AND.APLF.D5	Alt Stand Bottom Stand		827x777x950	19	0.61	

TEKNİK ÖZELLİKLER

- 0/400 °C arasında ayarlanabilir pişirme sıcaklığı.
- 600x600 mm fırın pişirme taşı.
- 385 mm fırın iç yüksekliği.
- 365x210 mm kapı ölçüsü.
- LPG ve NG ile çalışabilme özelliği.
- Paslanmaz çelik iç hazne.
- Piezzo çakmak ile kontrol.
- Manuel iç sıcaklık göstergesi.
- Emniyet ventilli musluk.

TECHNICAL SPECIFICATIONS

- Adjustable cooking temperature between 0/400 °C
- Internal diameter: 600x600 mm
- Internal high: 385 mm
- Door dimension: 365x210 mm
- Adaptable to LPG or NG.
- Stainless steel internal reservoir.
- Piezo lighter ignition system.
- Manuel interior temperature indicator.
- Magnet safety valve.





Renk Seçenekleri
Color Options



Siyah / Black
AND.APLS.D5-W-B



Kırmızı / Red
AND.APLS.D5-W-K



Turuncu / Orange
AND.APLS.D5-W-T



Yeşil / Green
AND.APLS.D5-W-Y

* Lütfen, Siparişlerinizde ürün renk kodunu belirtiniz.
Please, Specify colour code on order.



Kod Code	Ürün Adı Description	İç Ebatlar Interior Dimensions	Ebatlar Dimension	Ağırlık Weight	Net Net
AND.APLS.D5-W	Odunlu Taş Tabanlı Pizza Fırını Wood Stone Base Pizza Oven	600x600	860x990x1760	117	0.61
AND.APLF.D5	Alt Stand Bottom Stand		827x777x950	19	0.61

TEKNİK ÖZELLİKLER

- 0/400 °C arasında pişirme sıcaklığı.
- 600x600 mm fırın pişirme taşı.
- 385 mm fırın iç yüksekliği.
- 365x210 mm kapı ölçüsü.
- Paslanmaz çelik iç hazne.
- Manuel iç sıcaklık göstergesi.

TECHNICAL SPECIFICATIONS

- Cooking temperature between 0/400 °C
- Internal diameter: 600x600 mm
- Internal high: 385 mm
- Door dimension: 365x210 mm
- Stainless steel internal reservoir.
- Manuel interior temperature indicator.





Kod Code	Ürün Adı Description	Ebatlar Dimension	İç Ebatlar Interior Dimensions	Net Net	Güç Power
		a x b x c (mm)	a x b x c (mm)	(m ³)	(kw)
APLF.D1	Gazlı Pide Lahmacun Fırını Emniyet Ventilli Gas Pitta and Turkish Pizza With Safety Valve	1200x1200x1720/2020	1000x1000	2.5	22
APLF.D2	Gazlı Pide Lahmacun Fırını Emniyet Ventilli Gas Pitta and Turkish Pizza With Safety Valve	1200x1400x1720/2020	1000x1200	2.9	27
APLF.D4	Gazlı Pide Lahmacun Fırını Emniyet Ventilli Gas Pitta and Turkish Pizza With Safety Valve	1400x1600x1720/2020	1200x1400	3.9	30
APLF.D5	Gazlı Pide Lahmacun Fırını Emniyet Ventilli Gas Pitta and Turkish Pizza With Safety Valve	1600x1800x1720/2020	1400x1600	4.9	35
AFÖT.00	Mermer Fırın Önü Tezgah Marble Top Counter	1400x1000x1000		1.4	

TEKNİK ÖZELLİKLER

- Lpg ve Ng ile çalışabilme özelliği.
- Magnet emniyet ventilli musluklar.
- 180/200 °C sıcaklığında çalışabilme.
- İç kısımda 300x300x35 mm ateş tuğlası.
- Üst kısım tamamen izolasyonludur.
- İstenilen renkte seramik dış kaplama.

TECHNICAL SPECIFICATIONS

- Lpg or Natural Gas.
- Magnet safety valve taps.
- Working temperature: 180/200 °C
- 300x300x35 mm firebrick coated into the oven.
- Pearlitied rock wool isolation at the top of oven.
- Ceramic outer coating in the desired color.

APLF.D1

- Gaz Tüketim Değeri (ng): 2,32 m³/h
- Gaz Tüketim Değeri (lpg): 1,72 kg/h

APLF.D2

- Gaz Tüketim Değeri (ng): 2,85 m³/h
- Gaz Tüketim Değeri (lpg): 2,11 kg/h

APLF.D4

- Gaz Tüketim Değeri (ng): 3,17 m³/h
- Gaz Tüketim Değeri (lpg): 2,35 kg/h

APLF.D5

- Gaz Tüketim Değeri (ng): 3,70 m³/h
- Gaz Tüketim Değeri (lpg): 2,74 kg/h

APLF.D1

- Gas Consumption (ng): 2,32 m³/h
- Gas Consumption (lpg): 1,72 kg/h

APLF.D2

- Gas Consumption (ng): 2,85 m³/h
- Gas Consumption (lpg): 2,11 kg/h

APLF.D4

- Gas Consumption (ng): 3,17 m³/h
- Gas Consumption (lpg): 2,35 kg/h

APLF.D5

- Gas Consumption (ng): 3,70 m³/h
- Gas Consumption (lpg): 2,74 kg/h



Kod Code	Ürün Adı Description	Ebatlar Dimension	İç Ebatlar Interior Dimensions	Ağırlık Weight	Net Net	Güç Power	Kapasite Capacity
		a x b x c (mm)	a x b x c (mm)	(kg)	(m ³)	(kw)	
AND.AGF.01-S	Gold Midi Pizza Fırın Tek Katlı Gold Midi Pizza Oven Single Layer	1134x1091x710	700x700x164	60	0.88	7.5	Ø 340 mm 4 Pizza
AND.AGF.01-D	Gold Midi Pizza Fırın İki Katlı Gold Midi Pizza Oven Double Layer	1134x1091x1032	700x700x164	120	1.28	15	Ø 340 mm 4+4 Pizza
AND.AGS.01	Fırın Alt Standı Oven Bottom Stand	1134x890x930		49	0.94		

TEKNİK ÖZELLİKLER

- İç sıcaklık göstergesi.
- 400 °C maksimum sıcaklık.
- Ayarlanabilir üst ve alt ısı dereceleri.
- Eşit ısı dağılımı.
- Termostat kontrol.
- Refraktör pişirme taşı.

TECHNICAL SPECIFICATIONS

- Interior temperature indicator.
- Maximum temperature: 400 °C
- Adjustable top and bottom heating degree for each layer.
- Homogenous heat distribution.
- Thermostat control.
- Baking bedplate made by refractory material.

AND.AGF.01-S

- Elektrik Girişi: 400V AC 3N PE
- Kablo Kesiti (mm²): 5x2,5

AND.AGF.01-D

- Elektrik Girişi: 400V AC 3N PE
- Kablo Kesiti (mm²): 5x4

AND.AGF.01-S

- Electric Input: 400V AC 3N PE
- Cable Cross Section (mm²): 5x2,5

AND.AGF.01-D

- Electric Input: 400V AC 3N PE
- Cable Cross Section (mm²): 5x4





Kod Code	Ürün Adı Description	Ebatlar Dimension	İç Ebatlar Interior Dimensions	Ağırlık Weight	Net Net	Güç Power	Kapasite Capacity
		a x b x c (mm)	a x b x c (mm)	(kg)	(m ³)	(kw)	
AND.AGF.02-S	Gold Maxi Pizza Fırın Tek Katlı Gold Maxi Pizza Oven Single Layer	1486x1091x710	1055x700x164	105	1.15	10	Ø 340 mm 6 Pizza
AND.AGF.02-D	Gold Maxi Pizza Fırın İki Katlı Gold Maxi Pizza Oven Double Layer	1486x1091x1032	1055x700x164	249	1.67	20	Ø 340 mm 6+6 Pizza
AND.AGS.02	Fırın Alt Standı Oven Bottom Stand	1486x890x430		62	1.23		

TEKNİK ÖZELLİKLER

- 400 °C maksimum sıcaklık.
- Ayarlanabilir üst ve alt ısı dereceleri.
- Eşit ısı dağılımı.
- Termostat kontrol.
- Refraktör pişirme taşı.

TECHNICAL SPECIFICATIONS

- Maximum temperature: 400 °C
- Adjustable top and bottom heating degree for each layer
- Homogenous heat distribution
- Thermostat control.
- Baking bedplate made by refractory material.

AND.AGF.02-S

- Elektrik Girişi: 400V AC 3N PE
- Kablo Kesiti (mm²): 5x2,5

AND.AGF.02-S

- Electric Input: 400V AC 3N PE
- Cable Cross Section (mm²): 5x2,5

AND.AGF.02-D

- Elektrik Girişi: 400V AC 3N PE
- Kablo Kesiti (mm²): 5x4

AND.AGF.02-D

- Electric Input: 400V AC 3N PE
- Cable Cross Section (mm²): 5x4





Kod Code	Ürün Adı Description	Ebatlar Dimension	İç Ebatlar Interior Dimensions	Ağırlık Weight	Net Net	Güç Power	Kapasite Capacity
		a x b x c (mm)	a x b x c (mm)	(kg)	(m ³)	(kw)	
AND.4	Elektrikli Pizza Fırını Tek Katlı Electrical Single Layer Pizza Oven	825x710x390	525x525x145	56	0,23	5.4	Ø 250 mm 4 Pizza
AND.5	Elektrikli Pizza Fırını Tek Katlı Electrical Single Layer Pizza Oven	890x810x435	620x620x174	70	0.31	5.7	Ø 300 mm 4 Pizza
AND.6	Elektrikli Pizza Fırını Tek Katlı Electrical Single Layer Pizza Oven	1190x810x435	920x620x174	90	0.41	7.5	Ø 300 mm 5 Pizza
AND.8	Elektrikli Pizza Fırını Tek Katlı Electrical Single Layer Pizza Oven	965x900x435	705x705x145	75	0.38	5.5	Ø 330 mm 4 Pizza
AND.9	Elektrikli Pizza Fırını Tek Katlı Electrical Single Layer Pizza Oven	1190x1100x435	920x920x174	99	0.78	15	Ø 300 mm 9 Pizza
AND.AS.4	Fırın Alt Standı Oven Bottom Stand	825x610x850		26	0.43		
AND.AS.5	Fırın Alt Standı Oven Bottom Stand	890x730x850		29	0.55		
AND.AS.6	Fırın Alt Standı Oven Bottom Stand	1190x730x850		34	0.74		
AND.AS.8	Fırın Alt Standı Oven Bottom Stand	965x800x850		37	0.65		
AND.AS.9	Fırın Alt Standı Oven Bottom Stand	1250x1120x850		41	1.19		

TEKNİK ÖZELLİKLER

- İç sıcaklık göstergesi.
- 400 °C maksimum sıcaklık.
- Ayarlanabilir üst ve alt ısı verimleri.
- Refraktör pişirme taşı.
- Fırın içi aydınlatma lambası.
- Paslanmaz çelik ön kapak.
- Dayanıklı ön kapak mekanizması.

TECHNICAL SPECIFICATIONS

- Interior temperature indicator.
- Maximum temperature: 400 °C
- Adjustable top and bottom heating output.
- Baking bedplate made by refractory material.
- Lighting inside the oven.
- Stainless steel front door.
- Durable front cover mechanism.

AND.4 / AND.5 / AND.6

- Elektrik Girişi: 400V AC 3N PE
- Kablo Kesiti (mm²): 5x2.5

AND.4 / AND.5 / AND.6

- Electric Input: 400V AC 3N PE
- Cable Cross Section (mm²): 5x2.5

AND.8 / AND.9

- Elektrik Girişi: 400V AC 3N PE
- Kablo Kesiti (mm²): 5x4

AND.8 / AND.9

- Electric Input: 400V AC 3N PE
- Cable Cross Section (mm²): 5x4



Kod Code	Ürün Adı Description	Ebatlar Dimension	İç Ebatlar Interior Dimensions	Ağırlık Weight	Net Net	Güç Power	Kapasite Capacity
		a x b x c (mm)	a x b x c (mm)	(kg)	(m ³)	(kw)	
AND.4+4	Elektrikli Pizza Fırını İki Katlı Electrical Two Layer Pizza Oven	825x710x670	525x525x145	95	0.40	10.9	Ø 250 mm 4+4 Pizza
AND.5+5	Elektrikli Pizza Fırını İki Katlı Electrical Two Layer Pizza Oven	890x810x760	620x620x174	120	0.53	11.4	Ø 300 mm 4+4 Pizza
AND.6+6	Elektrikli Pizza Fırını İki Katlı Electrical Two Layer Pizza Oven	1190x810x760	920x620x174	152	0.70	15	Ø 300 mm 5+5 Pizza
AND.8+8	Elektrikli Pizza Fırını İki Katlı Electrical Two Layer Pizza Oven	965x900x760	705x705x145	150	0.66	11	Ø 330 mm 4+4 Pizza
AND.9+9	Elektrikli Pizza Fırını İki Katlı Electrical Two Layer Pizza Oven	1190x1100x760	920x920x174	208	1.25	30	Ø 300 mm 9+9 Pizza
AND.AS.4	Fırın Alt Standı Oven Bottom Stand	825x610x850		26	0.43		
AND.AS.5	Fırın Alt Standı Oven Bottom Stand	890x730x850		29	0.55		
AND.AS.6	Fırın Alt Standı Oven Bottom Stand	1190x730x850		34	0.74		
AND.AS.8	Fırın Alt Standı Oven Bottom Stand	965x800x850		37	0.65		
AND.AS.9	Fırın Alt Standı Oven Bottom Stand	1250x1120x850		41	1.19		

TEKNİK ÖZELLİKLER

- İç sıcaklık göstergesi.
- 400 °C maksimum sıcaklık.
- Ayarlanabilir üst ve alt ısı verimleri.
- Refraktör pişirme taşı.
- Fırın içi aydınlatma lambası.
- Paslanmaz çelik ön kapak.
- Dayanıklı ön kapak mekanizması.

AND.4+4 / AND.5+5 / AND.6+6

- Elektrik Girişi: 400V AC 3N PE
- Kablo Kesiti (mm²): 5x2.5

AND.8+8 / AND.9+9

- Elektrik Girişi: 400V AC 3N PE
- Kablo Kesiti (mm²): 5x4

TECHNICAL SPECIFICATIONS

- Interior temperature indicator.
- Maximum temperature: 400 °C
- Adjustable top and bottom heating output.
- Baking bedplate made by refractory material.
- Lighting inside the oven.
- Stainless steel front door.
- Durable front cover mechanism.

AND.4+4 / AND.5+5 / AND.6+6

- Electric Input: 400V AC 3N PE
- Cable Cross Section (mm²): 5x2.5

AND.8+8 / AND.9+9

- Electric Input: 400V AC 3N PE
- Cable Cross Section (mm²): 5x4





Kod Code	Ürün Adı Description	Ebatlar Dimension	İç Ebatlar Interior Dimensions	Ağırlık Weight	Net Net	Güç Power	Kapasite Capacity
		a x b x c (mm)	a x b x c (mm)	(kg)	(m ³)	(kw)	
AND.4G	Gazlı Pizza Fırını Tek Katlı Gas Single Layer Pizza Oven	1100x950x520	615x615x150	109	0,54	16.10	Ø 300 mm 4 Pizza
AND.6G	Gazlı Pizza Fırını Tek Katlı Gas Single Layer Pizza Oven	1400x950x520	915x615x150	135	0.70	16.10	Ø 300 mm 6 Pizza
AND.9G	Gazlı Pizza Fırını Tek Katlı Gas Single Layer Pizza Oven	1400x1250x520	915x915x150	175	0.91	22	Ø 300 mm 9 Pizza
AND.4G-S	Fırın Alt Standı Oven Bottom Stand	908x865x850		41	0.67		
AND.6G-S	Fırın Alt Standı Oven Bottom Stand	1208x865x850		47	0.89		
AND.9G-S	Fırın Alt Standı Oven Bottom Stand	1208x1066x850		55	0.85		

TEKNİK ÖZELLİKLER

- LPG ve Ng ile çalışabilme özelliği.
- Elektronik ateşleme sistemi.
- Sürekli alev denetimi.
- Refraktör pişirme taşı.

TECHNICAL SPECIFICATIONS

- Adaptable to LPG or Ng.
- Electronic burner ignition.
- Constant flame control.
- Baking bedplate made by refractory material.

AND.4G / AND.6G

- Gaz Tüketim Değeri (ng): 1,70 m³/h
- Gaz Tüketim Değeri (lpg): 1,21 kg/h

AND.9G

- Gaz Tüketim Değeri (ng): 2,30 m³/h
- Gaz Tüketim Değeri (lpg): 1,90 kg/h

AND.4G / AND.6G

- Gas Consumption (ng): 1,70 m³/h
- Gas Consumption (lpg): 1,21 kg/h

AND.9G

- Gas Consumption (ng): 2,30 m³/h
- Gas Consumption (lpg): 1,90 kg/h





Kod Code	Ürün Adı Description	Ebatlar Dimension	İç Ebatlar Interior Dimensions	Ağırlık Weight	Net Net	Güç Power	Kapasite Capacity
		a x b x c (mm)	a x b x c (mm)	(kg)	(m ³)	(kw)	
AND.4+4G	Gazlı Pizza Fırını İki Katlı Gas Two Layer Pizza Oven	1100x950x990	615x615x150	221	1.03	32.20	Ø 300 mm 4+4 Pizza
AND.6+6G	Gazlı Pizza Fırını İki Katlı Gas Two Layer Pizza Oven	1400x950x990	915x615x150	295	1.32	32.20	Ø 300 mm 6+6 Pizza
AND.9+9G	Gazlı Pizza Fırını İki Katlı Gas Two Layer Pizza Oven	1400x1250x990	915x915x150	345	1.69	48	Ø 300 mm 9+9 Pizza
AND.4G-S	Fırın Alt Standı Oven Bottom Stand	908x865x850		41	0.67		
AND.6G-S	Fırın Alt Standı Oven Bottom Stand	1208x865x850		47	0.89		
AND.9G-S	Fırın Alt Standı Oven Bottom Stand	1208x1066x850		55	0.85		

TEKNİK ÖZELLİKLER

- LPG ve Ng ile çalışabilme özelliği.
- Elektronik ateşleme sistemi.
- Sürekli alev denetimi.
- Refraktör pişirme taşı.

TECHNICAL SPECIFICATIONS

- Adaptable to LPG or Ng.
- Electronic burner ignition.
- Constant flame control.
- Baking bedplate made by refractory material.

AND.4+4G / AND.6+6G

- Gaz Tüketim Değeri (ng): 3,40 m³/h
- Gaz Tüketim Değeri (lpg): 2,42 kg/h

AND.9+9G

- Gaz Tüketim Değeri (ng): 5,07 m³/h
- Gaz Tüketim Değeri (lpg): 3,80 kg/h

AND.4+4G / AND.6+6G

- Gas Consumption (ng): 3,40 m³/h
- Gas Consumption (lpg): 2,42 kg/h

AND.9+9G

- Gas Consumption (ng): 5,07 m³/h
- Gas Consumption (lpg): 3,80 kg/h



Fırınlar
Ovens

Elektrikli Konveyörlü Pizza Fırınları
Electrical Conveyor Pizza Ovens

andora

CE

DIGITAL CONTROL



Kod Code	Ürün Adı Description	Ebatlar Dimension	Ağırlık Weight	Net Net	Güç Power	Bant Ölçüsü Band Dimension
		a x b x c (mm)	(kg)	(m ³)	(kw)	(mm)
AND.A50E-1340	Elektrikli Konveyörlü Pizza Fırını Electrical Conveyor Pizza Oven	1710x1146x452	141	0.88	12.5	535x1360
AND.A60E-1530	Elektrikli Konveyörlü Pizza Fırını Electrical Conveyor Pizza Oven	1965x1236x452	192	1.09	13	610x1575
AND.A50-1340-AS	Fırın Alt Standı Oven Bottom Stand	720x935x650	20	0.43		
AND.A60-1530-AS	Fırın Alt Standı Oven Bottom Stand	1025x950x590	21	0.55		

TEKNİK ÖZELLİKLER

- Mikroişlemci (PLC) kontrollü programlama.
- Programlı hafızalama veya program dışı manuel çalışma olanağı.
- Komple paslanmaz çelik gövde.
- Düşük elektrik tüketimi ve ürüne odaklanan pişirme sistemi sayesinde homojen pişirme.
- LCD dokunmatik ekran ile kolay kullanım.
- 1-60 dk pişirme süresi aralığı.
- Hızlı ve verimli bir çalışma ile zamandan kazanım.
- Düşük enerji sarfiyatı.

AND.A50E-1340

- Elektrik Girişi: 400V AC 3N PE
- Kablo Kesiti (mm²): 5x2.5

AND.A60E-1530

- Elektrik Girişi: 400V AC 3N PE
- Kablo Kesiti (mm²): 5x2.5

TECHNICAL SPECIFICATIONS

- Microprocessor (PLC) controlled programming
- Programmed memory or non-program manual working memory.
- Complete stainless steel body.
- Low electric consumption and homogeneous cooking.
- Easy to use with LCD touch screen.
- Baking time range from 1 min to 60 min.
- Save time with fast and efficient work.
- Low energy consumption.

AND.A50E-1340

- Electric Input: 400V AC 3N PE
- Cable Cross Section (mm²): 5x2.5

AND.A60E-1530

- Electric Input: 400V AC 3N PE
- Cable Cross Section (mm²): 5x2.5

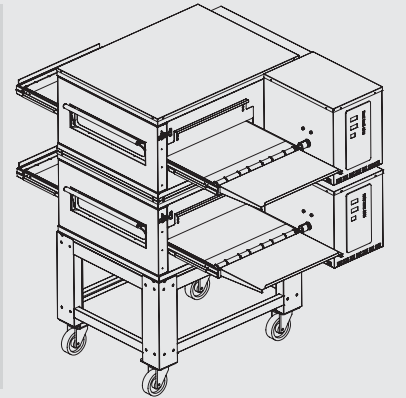

İki Katlı Modüler Sistem
Two Floor Modular System





Kod Code	Ürün Adı Description	Ebatlar Dimension	Ağırlık Weight	Net Net	Güç Power	Bant Ölçüsü Band Dimension
		a x b x c (mm)	(kg)	(m ³)	(kw)	(mm)
AND.A50G-1340	Gazlı Konveyörlü Pizza Fırını Gas Conveyor Pizza Oven	1710x1075x575	141	1.05	18	535x1360
AND.A60G-1530	Gazlı Konveyörlü Pizza Fırını Gas Conveyor Pizza Oven	1965x1185x575	200	1.22	18	610x1575
AND.A50-1340-AS	Fırın Alt Standı Oven Bottom Stand	720x935x650	20	0.43		
AND.A60-1530-AS	Fırın Alt Standı Oven Bottom Stand	1025x950x590	21	0.55		

TEKNİK ÖZELLİKLER

- Mikroişlemci (PLC) kontrollü programlama.
- Programlı hafızalama veya program dışı manuel çalışma olanağı.
- Komple paslanmaz çelik gövde.
- Düşük gaz tüketimi ve ürüne odaklanan pişirme sistemi sayesinde homojen pişirme.
- LCD dokunmatik ekran ile kolay kullanım.
- 1 dk ile 60 dk pişirme süresi aralığı.
- Hızlı ve verimli bir çalışma ile zamandan kazanım.
- Düşük gaz sarfiyatı.
- Lpg ve Ng ile çalışabilme özelliği.

AND.A50G-1340

- Gaz Tüketim Değeri (ng): 1,90 m³/h
- Gaz Tüketim Değeri (lpg): 1,41 kg/h

AND.A60G-1530

- Gaz Tüketim Değeri (ng): 1,90 m³/h
- Gaz Tüketim Değeri (lpg): 1,41 kg/h

TECHNICAL SPECIFICATIONS

- Microprocessor (PLC) controlled programming.
- Programmed memory or non-program manual working memory.
- Complete stainless steel body.
- Low gas consumption and homogeneous cooking.
- Easy to use with LCD touch screen.
- Baking time range from 1 min to 60 min.
- Save time with fast and efficient work.
- Low gas consumption.
- Lpg or Natural Gas.

A.A50G-1340

- Gas Consumption (ng): 1,90 m³/h
- Gas Consumption (lpg): 1,41 kg/h

A.A60G-1530

- Gas Consumption (ng): 1,90 m³/h
- Gas Consumption (lpg): 1,41 kg/h

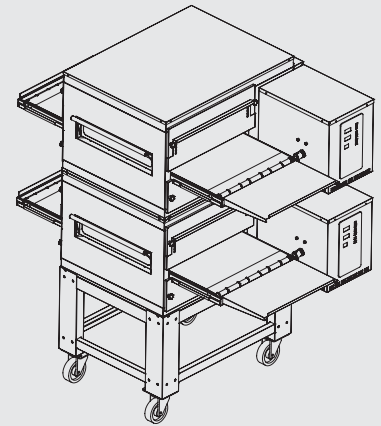

İki Katlı Modüler Sistem
Two Floor Modular System



Fırınlr Ovens

Gazlı Pasta Börek Fırınlr (Emniyet Ventilli) Gas Pastry Ovens (with Safety Valve)

andora

CE



Kod Code	Ürün Adı Description	Ebatlar Dimension	Net Net	Güç Power	Kapasite Capacity
		a x b x c (mm)	(m ³)	(kw)	(Izgara Raf / Rack Shelf)
AND.D1	Pasta Börek Fırını Emniyet Ventilli Pastry Oven with Safety Valve	950x950x1700	1.53	17.41	5

TEKNİK ÖZELLİKLER

- LPG ve Ng ile çalışabilme özelliği.
- Doğalgaz ile çalışan pasta börek fırınlarında; magnet emniyet ventilli musluklar.
- Paslanmaz çelik gövde.

TECHNICAL SPECIFICATIONS

- Adaptable to LPG or Ng.
- Magnet safety valves provide security on Ng operated ovens.
- Stainless steel body.

AND.D1

- Gaz Tüketim Değeri (ng): 1,84 m³/h
- Gaz Tüketim Değeri (lpg): 1,31 kg/h

AND.D1

- Gas Consumption (ng): 1,84 m³/h
- Gas Consumption (lpg): 1,31 kg/h

Soğutma Ekipmanları

Cooling Equipment



andora



SOĞUTMA EKİPMANLARI

- Tezgah Tipi Buzdolapları (Fanlı)
- Çekmeceli Tezgah Tipi Buzdolapları (Fanlı Soğutma)
- Tezgah Tipi Derin Dondurucular (Fanlı Soğutma)
- Camlı Tezgah Tipi Buzdolapları (Fanlı Soğutma)
- Evyeli Tezgah Tipi Buzdolapları (Fanlı Soğutma)
- Set Altı Buzdolapları (Fanlı Soğutma)
- Pizza ve Salata Hazırlık Buzdolapları (Fanlı Soğutma)
- Set Üstü Saladbarlar
- Granit Tablalı Pizza Hazırlık Buzdolapları (Fanlı Soğutma)
- Granit Tablalı Saladbarlı Hazırlık Buzdolapları
- Dik Tip Buzdolapları (Fanlı Soğutma)
- Camlı Dik Tip Buzdolapları (Fanlı Soğutma)
- Dik Tip Derin Dondurucular (Fanlı Soğutma)
- Dik Tip Pastane Buzdolapları (Fanlı Soğutma)
- Dik Tip Pastane Derin Dondurucular (Fanlı Soğutma)
- Dik Tip Pastane Buzdolapları (Fanlı Soğutma)
- Dik Tip Pastane Derin Dondurucular (Fanlı Soğutma)

COOLING EQUIPMENT

- Counter Type Refrigerators (Fan Cooling)
- Counter Type Refrigerators with Drawers (Fan Cooling)
- Counter Type Deep Freezers (Fan Cooling)
- Counter Type Refrigerators with Glass Door (Fan Cooling)
- Counter Type Refrigerators with Sink (Fan Cooling)
- Under Set Refrigerators (Fan Cooling)
- Pizza and Salad Preparation Refrigerators (Fan Cooling)
- Refrigerated Countertop Saladbars
- Granite Top Pizza Preparation Refrigerators (Fan Cooling)
- Granite Top Refrigerators with Saladbar
- Upright Refrigerators (Fan Cooling)
- Upright Refrigerators with Glass (Fan Cooling)
- Upright Deep Freezers (Fan Cooling)
- Upright Patisserie Refrigerators (Fan Cooling)
- Upright Patisserie Deep Freezers (Fan Cooling)
- Upright Patisserie Refrigerators (Fan Cooling)
- Upright Patisserie Deep Freezers (Fan Cooling)



Kod Code	Ürün Adı Description	Ebatlar Dimension	Ağırlık Weight	Net Net	Güç Power	Kapasite Capacity
		a x b x c (mm)	(kg)	(m ³)	(kw)	(lt)
AND.A125.60.01	Tezgah Tipi Buzdolabı 2 Kapılı Counter Type Refrigerator with 2 Doors	1250x600x850	86	0.65	0.14	175
AND.A125.70.01	Tezgah Tipi Buzdolabı 2 Kapılı Counter Type Refrigerator with 2 Doors	1250x700x850	86	0.65	0.14	200
AND.A150.60.01	Tezgah Tipi Buzdolabı 2 Kapılı Counter Type Refrigerator with 2 Doors	1500x600x850	106	0.8	0.14	250
AND.A150.70.01	Tezgah Tipi Buzdolabı 2 Kapılı Counter Type Refrigerator with 2 Doors	1500x700x850	115	0.9	0.14	300
AND.A200.60.01	Tezgah Tipi Buzdolabı 3 Kapılı Counter Type Refrigerator with 3 Doors	2000x600x850	135	1	0.16	400
AND.A200.70.01	Tezgah Tipi Buzdolabı 3 Kapılı Counter Type Refrigerator with 3 Doors	2000x700x850	142	1.2	0.16	500
AND.A255.60.01	Tezgah Tipi Buzdolabı 4 Kapılı Counter Type Refrigerator with 4 Doors	2550x600x850	176	1.3	0.20	550
AND.A255.70.01	Tezgah Tipi Buzdolabı 4 Kapılı Counter Type Refrigerator with 4 Doors	2550x700x850	186	1.5	0.20	700

TEKNİK ÖZELLİKLER

- Çalışma aralığı 0/+5 °C (tropikal 43 °C)
- 220-230V -1 +N 50-60 Hz elektrik gücü.
- "CFC Free" R-134 A soğutucu gaz.
- 40 kg/m³ yoğunluk.
- Sıcaklık ve defrost kontrollü dijital gösterge.
- Defrost esnasında otomatik su buharlaştırma.
- Fanlı soğutma.
- 48 mm kalınlığında "ozon dostu" poliüretan izolasyon.
- 45 derecede sabit kendiliğinden kapanan kapılar.
- Alüminyum panelli,bakır borulu evaporatör.
- Ayarlanabilir, paslanmaz çelik raf yuvaları, plastik raflar.
- Paslanmaz çelik gövde.

TECHNICAL SPECIFICATIONS

- Working temperature; 0/+5 °C at tropical ambient temperature 43 °C
- 220-230V -1 +N 50-60 Hz electrical power.
- "CFC Free" R-134 A refrigerant gas.
- 40 kg/m³ density.
- Temperature and defrost controlled digital display.
- Automatic evaporation of water during defrosting.
- Cooling with fan.
- Ozone-friendly" 48 mm thickness polyurethane isolation.
- Self-closing doors at 45 degrees.
- Copper tube evaporator with aluminum fins.
- Adjustable, stainless steel shelf housing, plastic coated shelves.
- Stainless steel body.



Monoblok Soğutma Sistemi
Monoblock Cooling System

Soğutma Ekipmanları Cooling Equipment

Çekmeceli Tezgah Tipi Buzdolapları (Fanlı Soğutma) Counter Type Refrigerators with Drawers (Fan Cooling)

andora

CE



Kod Code	Ürün Adı Description	Ebatlar Dimension	Ağırlık Weight	Net Net	Güç Power	Kapasite Capacity
		a x b x c (mm)	(kg)	(m ³)	(kw)	(lt)
AND.A150.70.01-2C	Tezgah Tipi Buzdolabı 2 Çekmece+1 Kapı Counter Type Refrigerator 2 Drawers+1 Door	1500x700x850	137	0.9	0.14	300
AND.A150.70.01-4C	Tezgah Tipi Buzdolabı 4 Çekmece Counter Type Refrigerator 4 Drawers	1500x700x850	160	0.9	0.17	300
AND.A200.70.01-2C	Tezgah Tipi Buzdolabı 2 Çekmece+2 Kapı Counter Type Refrigerator 2 Drawers+2 Doors	2000x700x850	163	1.2	0.16	500
AND.A200.70.01-4C	Tezgah Tipi Buzdolabı 4 Çekmece+1 Kapı Counter Type Refrigerator 4 Drawers+1 Door	2000x700x850	182	1.2	0.16	500
AND.A200.70.01-6C	Tezgah Tipi Buzdolabı 6 Çekmece Counter Type Refrigerator 6 Drawers	2000x700x850	207	1.2	0.31	550
AND.A255.70.01-2C	Tezgah Tipi Buzdolabı 2 Çekmece+3 Kapı Counter Type Refrigerator 2 Drawers+3 Doors	2550x700x850	207	1.5	0.21	700
AND.A255.70.01-4C	Tezgah Tipi Buzdolabı 4 Çekmece+2 Kapı Counter Type Refrigerator 4 Drawers+2 Doors	2550x700x850	226	1.5	0.21	700
AND.A255.70.01-6C	Tezgah Tipi Buzdolabı 6 Çekmece+1 Kapı Counter Type Refrigerator 6 Drawers +1 Door	2550x700x850	248	1.5	0.37	700
AND.A255.70.01-8C	Tezgah Tipi Buzdolabı 8 Çekmece Counter Type Refrigerator 8 Drawers	2550x700x850	275	1.5	0.60	700

TEKNİK ÖZELLİKLER

- 1/1 150 Gn kapasiteli çekmeceler.
- Çalışma aralığı 0/+5 °C (tropikal 43 °C)
- 220-230V -1 +N 50-60 Hz elektrik gücü.
- "CFC Free" R-134 A soğutucu gaz.
- 40 kg/m³ yoğunluk.
- Sıcaklık ve defrost kontrollü dijital gösterge.
- Defrost esnasında otomatik su buharlaştırma.
- Fanlı soğutma.
- 48 mm kalınlığında "ozon dostu" poliüretan izolasyon.
- 45 derecede sabit kendiliğinden kapanan kapılar.
- Alüminyum panelli,bakır borulu evaporatör.
- Ayarlanabilir, paslanmaz çelik raf yuvaları, plastik raflar.
- Paslanmaz çelik gövde.

TECHNICAL SPECIFICATIONS

- Drawers with 1/1 150 Gn capacity.
- Working temperature; 0/+5 °C at tropical ambient temperature 43 °C
- 220-230V -1 +N 50-60 Hz electrical power.
- "CFC Free" R-134 A refrigerant gas.
- 40 kg/m³ density.
- Temperature and defrost controlled digital display.
- Automatic evaporation of water during defrosting.
- Cooling with fan.
- Ozone-friendly" 48 mm thickness polyurethane isolation.
- Self-closing doors at 45 degrees.
- Copper tube evaporator with aluminum fins.
- Adjustable, stainless steel shelf housing, plastic coated shelves.
- Stainless steel body.



Monoblok Soğutma Sistemi
Monoblock Cooling System



Kod Code	Ürün Adı Description	Ebatlar Dimension	Ağırlık Weight	Net Net	Güç Power	Kapasite Capacity
		a x b x c (mm)	(kg)	(m ³)	(kw)	(lt)
AND.A125.60.02	Tezgah Tipi Derin Dondurucu 2 Kapılı Counter Type Deep Freezer with 2 Doors	1250x600x850	86	0.65	0.59	175
AND.A125.70.02	Tezgah Tipi Derin Dondurucu 2 Kapılı Counter Type Deep Freezer with 2 Doors	1250x700x850	86	0.65	0.59	200
AND.A150.60.02	Tezgah Tipi Derin Dondurucu 2 Kapılı Counter Type Deep Freezer with 2 Doors	1500x600x850	118	0.8	0.59	250
AND.A150.70.02	Tezgah Tipi Derin Dondurucu 2 Kapılı Counter Type Deep Freezer with 2 Doors	1500x700x850	127	0.9	0.59	300
AND.A200.60.02	Tezgah Tipi Derin Dondurucu 3 Kapılı Counter Type Deep Freezer with 3 Doors	2000x600x850	147	1	0.70	400
AND.A200.70.02	Tezgah Tipi Derin Dondurucu 3 Kapılı Counter Type Deep Freezer with 3 Doors	2000x700x850	155	1.2	0.70	500
AND.A255.60.02	Tezgah Tipi Derin Dondurucu 4 Kapılı Counter Type Deep Freezer with 4 Doors	2550x600x850	190	1.3	0.98	550
AND.A255.70.02	Tezgah Tipi Derin Dondurucu 4 Kapılı Counter Type Deep Freezer with 4 Doors	2550x700x850	206	1.5	0.98	700

TEKNİK ÖZELLİKLER

- Çalışma aralığı, -18/-20 °C (tropikal 43 °C)
- 220-230V -1 +N 50-60 Hz elektrik gücü.
- "CFC Free" R-290 soğutucu gaz.
- 40 kg/m³ yoğunluk.
- Sıcaklık ve defrost kontrollü dijital gösterge.
- Defrost esnasında otomatik su buharlaştırma.
- Fanlı soğutma.
- 48 mm kalınlığında "ozon dostu" poliüretan izolasyon.
- 45 derecede sabit kendiliğinden kapanan kapılar.
- Alüminyum panelli, bakır borulu evaporatör.
- Ayarlanabilir, paslanmaz çelik raf yuvaları, plastik raflar.
- Paslanmaz çelik gövde.

TECHNICAL SPECIFICATIONS

- Working temperature -18/-20 °C at tropical ambient temperature 43 °C
- 220-230V -1 +N 50-60 Hz electrical power.
- "CFC Free" R-290 refrigerant gas.
- 40 kg/m³ density.
- Temperature and defrost controlled digital display.
- Automatic evaporation of water during defrosting.
- Cooling with fan.
- Ozone-friendly" 48 mm thickness polyurethane isolation.
- Self-closing doors at 45 degrees.
- Copper tube evaporator with aluminum fins.
- Adjustable, stainless steel shelf housing, plastic coated shelves.
- Stainless steel body.



Kod Code	Ürün Adı Description	Ebatlar Dimension	Ağırlık Weight	Net Net	Güç Power	Kapasite Capacity
		a x b x c (mm)	(kg)	(m³)	(kw)	(lt)
AND.A150.60.03	Camlı Tezgah Tipi Buzdolabı 2 Kapılı Counter Type Refrigerator with 2 Doors	1500x600x850	112	0.8	0.17	250
AND.A150.70.03	Camlı Tezgah Tipi Buzdolabı 2 Kapılı Counter Type Refrigerator with 2 Doors	1500x700x850	120	0.9	0.17	300
AND.A200.60.03	Camlı Tezgah Tipi Buzdolabı 3 Kapılı Counter Type Refrigerator with 3 Doors	2000x600x850	140	1	0.20	400
AND.A200.70.03	Camlı Tezgah Tipi Buzdolabı 3 Kapılı Counter Type Refrigerator with 3 Doors	2000x700x850	148	1.2	0.20	500
AND.A255.60.03	Camlı Tezgah Tipi Buzdolabı 4 Kapılı Counter Type Refrigerator with 4 Doors	2550x600x850	183	1.3	0.25	550
AND.A255.70.03	Camlı Tezgah Tipi Buzdolabı 4 Kapılı Counter Type Refrigerator with 4 Doors	2550x700x850	193	1.5	0.25	700

TEKNİK ÖZELLİKLER

- Çalışma aralığı 0/+5 °C (tropikal 43 °C)
- 220-230V -1 +N 50-60 Hz elektrik gücü.
- "CFC Free" R-134 A soğutucu gaz.
- 40 kg/m³ yoğunluk.
- Sıcaklık ve defrost kontrollü dijital gösterge.
- Defrost esnasında otomatik su buharlaştırma.
- Fanlı soğutma.
- 48 mm kalınlığında "ozon dostu" poliüretan izolasyon.
- 45 derecede sabit kendiliğinden kapanan kapılar.
- Alüminyum panelli, bakır borulu evaporatör.
- Ayarlanabilir, paslanmaz çelik raf yuvaları, plastik raflar.
- Paslanmaz çelik gövde.

TECHNICAL SPECIFICATIONS

- Working temperature; 0/+5 °C at tropical ambient temperature 43 °C
- 220-230V -1 +N 50-60 Hz electrical power.
- "CFC Free" R-134 A refrigerant gas.
- 40 kg/m³ density.
- Temperature and defrost controlled digital display.
- Automatic evaporation of water during defrosting.
- Cooling with fan.
- Ozone-friendly" 48 mm thickness polyurethane isolation.
- Self-closing doors at 45 degrees.
- Copper tube evaporator with aluminum fins.
- Adjustable, stainless steel shelf housing, plastic coated shelves.
- Stainless steel body.



Monoblok Soğutma Sistemi
Monoblock Cooling System



Kod Code	Ürün Adı Description	Ebatlar Dimension	Ağırlık Weight	Net Net	Güç Power	Kapasite Capacity
		a x b x c (mm)	(kg)	(m ³)	(kw)	(lt)
AND.A150.70.01-EV	Evyeli Tezgah Tip Buzdolabı 2 Kapılı Counter Type Refrigerator with Sink+2 Doors	1500x700x850	116	0.9	0.14	300
AND.A200.70.01-EV	Evyeli Tezgah Tip Buzdolabı 3 Kapılı Counter Type Refrigerator with Sink+3 Doors	2000x700x850	143	1.2	0.16	500
AND.A255.70.01-EV	Evyeli Tezgah Tip Buzdolabı 4 Kapılı Counter Type Refrigerator with Sink+4 Doors	2550x700x850	188	1.5	0.20	700

TEKNİK ÖZELLİKLER

- Evye ölçüsü 350x400 mm
- Çalışma aralığı 0/+5 °C (tropikal 43 °C)
- 220-230V -1 +N 50-60 Hz elektrik gücü.
- "CFC Free" R-134 A soğutucu gaz.
- 40 kg/m³ yoğunluk.
- Sıcaklık ve defrost kontrollü dijital gösterge.
- Defrost esnasında otomatik su buharlaştırma.
- Fanlı soğutma.
- 48 mm kalınlığında "ozon dostu" poliüretan izolasyon.
- 45 derecede sabit kendiliğinden kapanan kapılar.
- Alüminyum panelli,bakır borulu evaporatör.
- Ayarlanabilir, paslanmaz çelik raf yuvaları, plastik raflar.
- Paslanmaz çelik gövde.

TECHNICAL SPECIFICATIONS

- Sink dimensions 350x400 mm
- Working temperature; 0/+5 °C at tropical ambient temperature 43 °C
- 220-230V -1 +N 50-60 Hz electrical power.
- "CFC Free" R-134 A refrigerant gas.
- 40 kg/m³ density.
- Temperature and defrost controlled digital display.
- Automatic evaporation of water during defrosting.
- Cooling with fan.
- Ozone-friendly" 48 mm thickness polyurethane isolation.
- Self-closing doors at 45 degrees.
- Copper tube evaporator with aluminum fins.
- Adjustable,stainless steel shelf housing, plastic coated shelves.
- Stainless steel body.

Soğutma Ekipmanları Cooling Equipment

Set Altı Buzdolapları (Fanlı Soğutma) Under Set Refrigerators (Fan Cooling)

andora

CE



Kod Code	Ürün Adı Description	Ebatlar Dimension	Ağırlık Weight	Net Net	Güç Power	Kapasite Capacity
		a x b x c (mm)	(kg)	(m ³)	(kw)	(gn/container)
AND.A160.60.01-S	Set Altı Buzdolabı 4 Çekmeceli Under Set Refrigerator with 4 Drawers	1600x600x600	120	0.5	0.22	4x2/3 100
AND.A200.60.01-S	Set Altı Buzdolabı 6 Çekmeceli Under Set Refrigerator with 6 Drawers	2000x600x600	156	0.6	0.23	6x2/3 100
AND.A160.70.01-S	Set Altı Buzdolabı 4 Çekmeceli Under Set Refrigerator with 4 Drawers	1600x700x600	135	0.6	0.23	4x1/1 100
AND.A200.70.01-S	Set Altı Buzdolabı 6 Çekmeceli Under Set Refrigerator with 6 Drawers	2000x700x600	173	0.8	0.23	6x1/1 100
AND.A240.60.01-S	Set Altı Buzdolabı 8 Çekmeceli Under Set Refrigerator with 8 Drawers	2400x600x600	182	0.9	0.23	8x2/3 100
AND.A240.70.01-S	Set Altı Buzdolabı 8 Çekmeceli Under Set Refrigerator with 8 Drawers	2400x700x600	182	0.9	0.23	8x1/1 100

TEKNİK ÖZELLİKLER

- Çalışma aralığı 0/+5 °C (tropikal 43 °C)
- 220-230V -1 +N 50-60 Hz elektrik gücü.
- "CFC Free" R-134 A soğutucu gaz.
- 40 kg/m³ yoğunluk.
- Sıcaklık ve defrost kontrollü dijital gösterge.
- Defrost esnasında otomatik su buharlaştırma.
- Fanlı soğutma.
- 48 mm kalınlığında "ozon dostu" poliüretan izolasyon.
- Alüminyum panelli, bakır borulu evaporatör.
- Paslanmaz çelik gövde.

TECHNICAL SPECIFICATIONS

- Working temperature; 0/+5 °C at tropical ambient temperature 43 °C
- 220-230V -1 +N 50-60 Hz electrical power.
- "CFC Free" R-134 A refrigerant gas.
- 40 kg/m³ density.
- Temperature and defrost controlled digital display.
- Automatic evaporation of water during defrosting.
- Cooling with fan.
- Ozone-friendly" 48 mm thickness polyurethane isolation.
- Copper tube evaporator with aluminum fins.
- Stainless steel body.



Kod Code	Ürün Adı Description	Ebatlar Dimension	Ağırlık Weight	Net Net	Güç Power	Kapasite Capacity
		a x b x c (mm)	(kg)	(m ³)	(kw)	(gn/container)
AND.A160.60.02-S	Set Altı Dondurucu 4 Çekmeceli Under Set Freezer with 4 Drawers	1600x600x600	120	0.5	0.22	4x2/3 100
AND.A200.60.02-S	Set Altı Dondurucu 6 Çekmeceli Under Set Freezer with 6 Drawers	2000x600x600	156	0.6	0.23	6x2/3 100
AND.A160.70.02-S	Set Altı Dondurucu 4 Çekmeceli Under Set Freezer with 4 Drawers	1600x700x600	135	0.6	0.23	4x1/1 100
AND.A200.70.02-S	Set Altı Dondurucu 6 Çekmeceli Under Set Freezer with 6 Drawers	2000x700x600	173	0.8	0.23	6x1/1 100
AND.A240.60.02-S	Set Altı Dondurucu 8 Çekmeceli Under Set Freezer with 8 Drawers	2400x600x600	182	0.9	0.23	8x2/3 100
AND.A240.70.02-S	Set Altı Dondurucu 8 Çekmeceli Under Set Freezer with 8 Drawers	2400x700x600	182	0.9	0.23	8x1/1 100

TEKNİK ÖZELLİKLER

- Çalışma aralığı -18/-20 °C (tropikal 43 °C)
- 220-230V -1 +N 50-60 Hz elektrik gücü.
- "CFC Free" R-290 soğutucu gaz.
- 40 kg/m³ yoğunluk.
- Sıcaklık ve defrost kontrollü dijital gösterge.
- Defrost esnasında otomatik su buharlaştırma.
- Fanlı soğutma.
- 48 mm kalınlığında "ozon dostu" poliüretan izolasyon.
- Alüminyum panelli, bakır borulu evaporatör.
- Paslanmaz çelik gövde.

TECHNICAL SPECIFICATIONS

- Working temperature -18/-20 °C at tropical ambient temperature 43 °C
- 220-230V -1 +N 50-60 Hz electrical power.
- "CFC Free" R-290 refrigerant gas.
- 40 kg/m³ density.
- Temperature and defrost controlled digital display.
- Automatic evaporation of water during defrosting.
- Cooling with fan.
- Ozone-friendly" 48 mm thickness polyurethane isolation.
- Copper tube evaporator with aluminum fins.
- Stainless steel body.



Kod Code	Ürün Adı Description	Ebatlar Dimension	Ağırlık Weight	Net Net	Güç Power	Kapasite Capacity
		a x b x c (mm)	(kg)	(m ³)	(kw)	(gn/container)
AND.A160.60.01-S-T	Set Altı Derin 2 Çekmeceli Buzdolabı Under Set Deep Drawer Refrigerator with 2 Drawers	1600x600x600	120	0.5	0.22	4x2/3 100
AND.A200.60.01-S-T	Set Altı Derin 3 Çekmeceli Buzdolabı Under Set Deep Drawer Refrigerator with 3 Drawers	2000x600x600	156	0.6	0.23	6x2/3 100
AND.A160.70.01-S-T	Set Altı Derin 2 Çekmeceli Buzdolabı Under Set Deep Drawer Refrigerator with 2 Drawers	1600x700x600	135	0.6	0.23	4x1/1 100
AND.A200.70.01-S-T	Set Altı Derin 3 Çekmeceli Buzdolabı Under Set Deep Drawer Refrigerator with 3 Drawers	2000x700x600	173	0.8	0.23	6x1/1 100
AND.A240.60.01-S-T	Set Altı Derin 4 Çekmeceli Buzdolabı Under Set Deep Drawer Refrigerator with 4 Drawers	2400x600x600	182	0.9	0.23	8x2/3 100
AND.A240.70.01-S-T	Set Altı Derin 4 Çekmeceli Buzdolabı Under Set Deep Drawer Refrigerator with 4 Drawers	2400x700x600	182	0.9	0.23	8x1/1 100

TEKNİK ÖZELLİKLER

- Çalışma aralığı 0/+5 °C (tropikal 43 °C)
- 220-230V -1 +N 50-60 Hz elektrik gücü.
- "CFC Free" R-134 A soğutucu gaz.
- 40 kg/m³ yoğunluk.
- Sıcaklık ve defrost kontrollü dijital gösterge.
- Defrost esnasında otomatik su buharlaştırma.
- Fanlı soğutma.
- 48 mm kalınlığında "ozon dostu" poliüretan izolasyon.
- Alüminyum panelli, bakır borulu evaporatör.
- Paslanmaz çelik gövde.

TECHNICAL SPECIFICATIONS

- Working temperature; 0/+5 °C at tropical ambient temperature 43 °C
- 220-230V -1 +N 50-60 Hz electrical power.
- "CFC Free" R-134 A refrigerant gas.
- 40 kg/m³ density.
- Temperature and defrost controlled digital display.
- Automatic evaporation of water during defrosting.
- Cooling with fan.
- Ozone-friendly" 48 mm thickness polyurethane isolation.
- Copper tube evaporator with aluminum fins.
- Stainless steel body.



Kod Code	Ürün Adı Description	Ebatlar Dimension	Ağırlık Weight	Net Net	Güç Power	Kapasite Capacity
		a x b x c (mm)	(kg)	(m ³)	(kw)	(gn/container)
AND.A160.60.02-S-T	Set Altı Derin 2 Çekmeceli Dondurucu Under Set Deep Drawer Freezer with 2 Drawers	1600x600x600	120	0.5	0.22	4x2/3 100
AND.A200.60.02-S-T	Set Altı Derin 3 Çekmeceli Dondurucu Under Set Deep Drawer Freezer with 3 Drawers	2000x600x600	156	0.6	0.23	6x2/3 100
AND.A160.70.02-S-T	Set Altı Derin 2 Çekmeceli Dondurucu Under Set Deep Drawer Freezer with 2 Drawers	1600x700x600	135	0.6	0.23	4x1/1 100
AND.A200.70.02-S-T	Set Altı Derin 3 Çekmeceli Dondurucu Under Set Deep Drawer Freezer with 3 Drawers	2000x700x600	173	0.8	0.23	6x1/1 100
AND.A240.60.02-S-T	Set Altı Derin 4 Çekmeceli Dondurucu Under Set Deep Drawer Freezer with 4 Drawers	2400x600x600	182	0.9	0.23	8x2/3 100
AND.A240.70.02-S-T	Set Altı Derin 4 Çekmeceli Dondurucu Under Set Deep Drawer Freezer with 4 Drawers	2400x700x600	182	0.9	0.23	8x1/1 100

TEKNİK ÖZELLİKLER

- Çalışma aralığı, -18/-20 °C (tropikal 43 °C)
- 220-230V -1 +N 50-60 Hz elektrik gücü.
- "CFC Free" R-290 soğutucu gaz.
- 40 kg/m³ yoğunluk.
- Sıcaklık ve defrost kontrollü dijital gösterge.
- Defrost esnasında otomatik su buharlaştırma.
- Fanlı soğutma.
- 48 mm kalınlığında "ozon dostu" poliüretan izolasyon.
- Alüminyum panelli, bakır borulu evaporatör.
- Paslanmaz çelik gövde.

TECHNICAL SPECIFICATIONS

- Working temperature -18/-20 °C at tropical ambient temperature 43 °C
- 220-230V -1 +N 50-60 Hz electrical power.
- "CFC Free" R-290 refrigerant gas.
- 40 kg/m³ density.
- Temperature and defrost controlled digital display.
- Automatic evaporation of water during defrosting.
- Cooling with fan.
- Ozone-friendly" 48 mm thickness polyurethane isolation.
- Copper tube evaporator with aluminum fins.
- Stainless steel body.

Soğutma Ekipmanları Cooling Equipment

Pizza ve Salata Hazırlık Buzdolapları (Fanlı Soğutma) Pizza and Salad Preparation Refrigerators (Fan Cooling)

andora

CE



Kod Code	Ürün Adı Description	Ebatlar Dimension	Ağırlık Weight	Net Net	Güç Power	Kapasite Capacity
		a x b x c (mm)	(kg)	(m ³)	(kw)	(lt)
AND.A150.70.01-PS	Pizza Salata Buzdolabı 2 Kapılı Pizza and Salad Refrigerator with 2 Doors	1500x700x850/1050	143	0.9	0.13	300
AND.A200.70.01-PS	Pizza Salata Buzdolabı 3 Kapılı Pizza and Salad Refrigerator with 3 Doors	2000x700x850/1050	178	1.2	0.18	500

TEKNİK ÖZELLİKLER

- Çalışma aralığı 0/+5 °C (tropikal 43 °C)
- 220-230V -1 +N 50-60 Hz elektrik gücü.
- "CFC Free" R-134 A soğutucu gaz.
- 40 kg/m³ yoğunluk.
- Sıcaklık ve defrost kontrollü dijital göstergeler.
- Defrost esnasında otomatik su buharlaştırma.
- Fanlı soğutma.
- 48 mm kalınlığında "ozon dostu" poliüretan izolasyon.
- 45 derecede sabit kendiliğinden kapanan kapılar.
- Alüminyum panelli, bakır borulu evaporatör.
- Ayarlanabilir, paslanmaz çelik raf yuvaları, plastik raflar.
- Paslanmaz çelik gövde.

AND.A150.70.01-PS

- Saladbar kapasite; 8 adet 1/4-100 Gn küvet.

AND.A200.70.01-PS

- Saladbar kapasite; 10 adet 1/4-100 Gn küvet.

TECHNICAL SPECIFICATIONS

- Working temperature; 0/+5 °C at tropical ambient temperature 43 °C
- 220-230V -1 +N 50-60 Hz electrical power.
- "CFC Free" R-134 A refrigerant gas.
- 40 kg/m³ density.
- Temperature and defrost controlled digital display.
- Automatic evaporation of water during defrosting.
- Cooling with fan.
- Ozone-friendly" 48 mm thickness polyurethane isolation.
- Self-closing doors at 45 degrees.
- Copper tube evaporator with aluminum fins.
- Adjustable, stainless steel shelf housing, plastic coated shelves.
- Stainless steel body.

AND.A150.70.01-PS

- Saladbar capacity; 8 pieces 1/4-100 Gn container.

AND.A200.70.01-PS

- Saladbar capacity; 10 pieces 1/4-100 Gn container.

- Standart üretimimizde küvet bulunmamaktadır. / Standart product does not have containers.
- Gn küvet haznesi kapalı statik soğutmalıdır. / Gn container tank covered by static cooling.

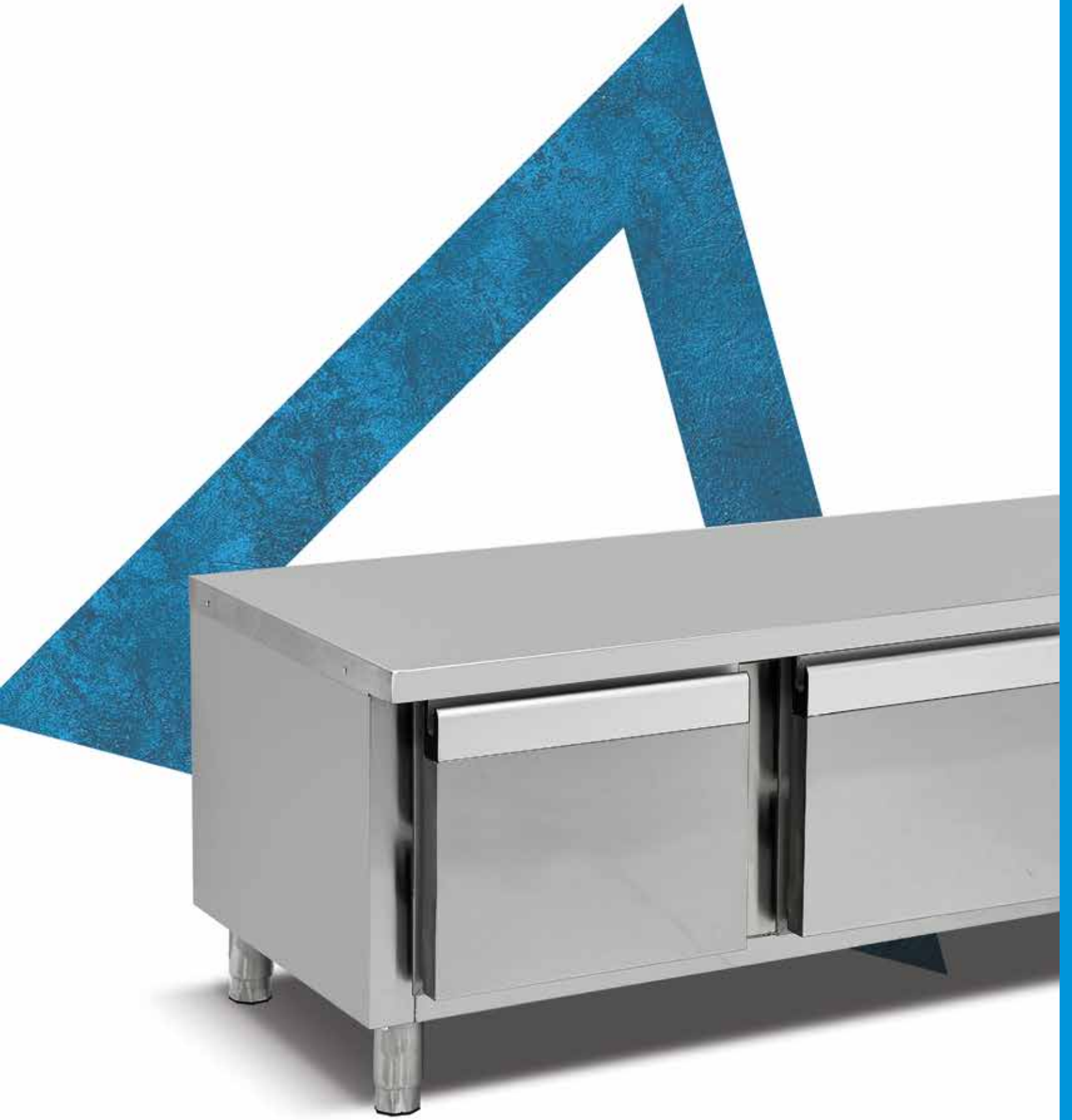

www.turkeyner.com

Soğutma Ekipmanları Cooling Equipment

Pizza ve Salata Hazırlık Buzdolapları (Fanlı Soğutma) Pizza and Salad Preparation Refrigerators (Fan Cooling)

andora

CE



Kod Code	Ürün Adı Description	Ebatlar Dimension	Ağırlık Weight	Net Net	Güç Power	Kapasite Capacity
		a x b x c (mm)	(kg)	(m ³)	(kw)	(lt)
AND.A150.70.01-PSO	Pizza ve Salata Buzdolabı 2 Kapılı Pizza and Salad Refrigerator with 2 Doors	1500x700x850	130	0.9	0.25	300
AND.A200.70.01-PSO	Pizza ve Salata Buzdolabı 3 Kapılı Pizza and Salad Refrigerator with 3 Doors	2000x700x850	159	1.2	0.25	500

TEKNİK ÖZELLİKLER

- Çalışma aralığı 0/+5 °C (tropikal 43 °C)
- 220-230V -1 +N 50-60 Hz elektrik gücü.
- "CFC Free" R-134 A soğutucu gaz.
- 40 kg/m³ yoğunluk.
- Sıcaklık ve defrost kontrollü dijital gösterge.
- Defrost esnasında otomatik su buharlaştırma.
- Fanlı soğutma.
- 48 mm kalınlığında "ozon dostu" poliüretan izolasyon.
- 45 derecede sabit kendiliğinden kapanan kapılar.
- Alüminyum panelli, bakır borulu evaporatör.
- Ayarlanabilir, paslanmaz çelik raf yuvaları, plastik raflar.
- Paslanmaz çelik gövde.

AND.A150.70.01-PSO

- Saladbar kapasite; 6 adet 1/4-100 Gn küvet.

AND.A200.70.01-PSO

- Saladbar kapasite; 8 adet 1/4-100 Gn küvet.

TECHNICAL SPECIFICATIONS

- Working temperature; 0/+5 °C at tropical ambient temperature 43 °C
- 220-230V -1 +N 50-60 Hz electrical power.
- "CFC Free" R-134 A refrigerant gas.
- 40 kg/m³ density.
- Temperature and defrost controlled digital display.
- Automatic evaporation of water during defrosting.
- Cooling with fan.
- Ozone-friendly" 48 mm thickness polyurethane isolation.
- Self-closing doors at 45 degrees.
- Copper tube evaporator with aluminum fins.
- Adjustable, stainless steel shelf housing, plastic coated shelves.
- Stainless steel body.

AND.A150.70.01-PSO

- Saladbar capacity; 6 pieces 1/4-100 Gn container.

AND.A200.70.01-PSO

- Saladbar capacity; 8 pieces 1/4-100 Gn container.

- Standart üretimimizde küvet bulunmamaktadır. / Standart product does not have containers.
- Gn küvet haznesi kapalı statik soğutmalıdır. / Gn container tank covered by static cooling.



Kod Code	Ürün Adı Description	Ebatlar Dimension	Ağırlık Weight	Net Net	Güç Power	Kapasite Capacity
		a x b x c (mm)	(kg)	(m ³)	(kw)	(lt)
AND.A150.80.01-PSY	Pizza ve Salata Buzdolabı 2 Kapılı Pizza and Salad Refrigerator with 2 Doors	1500x800x850/1350	170	0.9	0.14	300
AND.A200.80.01-PSY	Pizza ve Salata Buzdolabı 3 Kapılı Pizza and Salad Refrigerator with 3 Doors	2000x800x850/1350	210	1.2	0.17	500
AND.A150.80.01-PSYG	Granitli Pizza ve Salata Buzdolabı 2 Kapılı Granite Pizza Salad Refrigerator 2 Doors	1500x800x850/1350	236	0.9	0.14	300
AND.A200.80.01-PSYG	Granitli Pizza ve Salata Buzdolabı 3 Kapılı Granite Pizza Salad Refrigerator 3 Doors	2000x800x850/1350	297	1.2	0.17	500

TEKNİK ÖZELLİKLER

- Her kapakta 4 adet 400x600 mm tepsi kapasitesi.
- Çalışma aralığı 0/+5 °C (tropikal 43 °C)
- 220-230V -1 +N 50-60 Hz elektrik gücü.
- "CFC Free" R-134 A soğutucu gaz.
- 40 kg/m³ yoğunluk.
- Sıcaklık ve defrost kontrollü dijital gösterge.
- Defrost esnasında otomatik su buharlaştırma.
- Fanlı soğutma.
- 48 mm kalınlığında "ozon dostu" poliüretan izolasyon.
- 45 derecede sabit kendiliğinden kapanan kapılar.
- Alüminyum panelli, bakır borulu evaporatör.
- Paslanmaz çelik gövde.

AND.A150.80.01-PSY - AND.A150.80.01-PSYG

- Saladbar kapasite; 8 adet 1/4-100 Gn küvet.

AND.A200.80.01-PSY - AND.A200.80.01-PSYG

- Saladbar kapasite; 11 adet 1/4-100 Gn küvet.

TECHNICAL SPECIFICATIONS

- 4 pieces 400x600 mm tray capacity on each cover.
- Working temperature; 0/+5 °C at tropical ambient temperature 43 °C
- 220-230V -1 +N 50-60 Hz electrical power.
- "CFC Free" R-134 A refrigerant gas.
- 40 kg/m³ density.
- Temperature and defrost controlled digital display.
- Automatic evaporation of water during defrosting.
- Cooling with fan.
- Ozone-friendly" 48 mm thickness polyurethane isolation.
- Self-closing doors at 45 degrees.
- Copper tube evaporator with aluminum fins.
- Stainless steel body.

AND.A150.80.01-PSY - AND.A150.80.01-PSYG

- Saladbar capacity; 8 pieces 1/4-100 Gn container.

AND.A200.80.01-PSY - AND.A200.80.01-PSYG

- Saladbar capacity; 11 pieces 1/4-100 Gn container.

- Standart üretimimizde küvet bulunmamaktadır. / Standart product does not have containers.

- Gn küvet haznesi kapalı statik soğutulmalıdır. / Gn container tank covered by static cooling.



Kod Code	Ürün Adı Description	Ebatlar Dimension	Ağırlık Weight	Net Net	Güç Power
		a x b x c (mm)	(kg)	(m ³)	(kw)
AND.160	Set Üstü Saladbar Refrigerated Countertop Saladbar	1600x350x500	65	0.17	0.2
AND.210	Set Üstü Saladbar Refrigerated Countertop Saladbar	2000x350x500	78	0.24	0.2

TEKNİK ÖZELLİKLER

- Çalışma aralığı 0/+5 °C (tropikal 43 °C)
- 220-230V -1 +N 50-60 Hz elektrik gücü.
- "CFC Free" R-134 A soğutucu gaz.
- 40 kg/m³ yoğunluk.
- Sıcaklık ve defrost kontrollü dijital gösterge.
- Defrost esnasında otomatik su buharlaştırma.
- Statik soğutma.
- 48 mm kalınlığında "ozon dostu" poliüretan izolasyon.
- Alüminyum panelli, bakır borulu evaporatör.
- Paslanmaz çelik gövde.

AND.160

- Kapasite; 7 adet 1/4-100 Gn küvet. **AND.210**
- Kapasite; 9 adet 1/4-100 Gn küvet.

TECHNICAL SPECIFICATIONS

- Working temperature; 0/+5 °C at tropical ambient temperature 43 °C
- 220-230V -1 +N 50-60 Hz electrical power.
- "CFC Free" R-134 A refrigerant gas.
- 40 kg/m³ density.
- Temperature and defrost controlled digital display.
- Automatic evaporation of water during defrosting.
- Static cooling.
- Ozone-friendly" 48 mm thickness polyurethane isolation.
- Copper tube evaporator with aluminum fins.
- Stainless steel body.

AND.160

- Capacity; 7 pieces 1/4-100 Gn container.

AND.210

- Capacity; 9 pieces 1/4-100 Gn container.

- Standart üretimimizde küvet bulunmamaktadır. / Standart product does not have containers.



Kod Code	Ürün Adı Description	Ebatlar Dimension	Ağırlık Weight	Net Net	Güç Power	Kapasite Capacity
		a x b x c (mm)	(kg)	(m ³)	(kw)	(lt)
AND.A160.80.01	Granit Tablalı Buzdolabı 2 Kapılı Granite Pizza Salad Refrigerator 2 Doors	1600x800x1020	250	1.1	0.12	300
AND.A210.80.01	Granit Tablalı Buzdolabı 3 Kapılı Granite Pizza Salad Refrigerator 3 Doors	2100x800x1020	305	1.5	0.16	500

TEKNİK ÖZELLİKLER

- Her kapakta 4 adet 400x600 mm tepsi kapasitesi.
- Çalışma aralığı 0/+5 °C (tropikal 43 °C)
- 220-230V -1 +N 50-60 Hz elektrik gücü.
- "CFC Free" R-134 A soğutucu gaz.
- 40 kg/m³ yoğunluk.
- Sıcaklık ve defrost kontrollü dijital gösterge.
- Defrost esnasında otomatik su buharlaştırma.
- Fanlı soğutma.
- 48 mm kalınlığında "ozon dostu" poliüretan izolasyon.
- 45 derecede sabit kendiliğinden kapanan kapılar.
- Alüminyum panelli, bakır borulu evaporatör.
- Paslanmaz çelik gövde.

AND.A160.80.01

- Saladbar kapasite; 8 adet 1/4-100 Gn küvet.

AND.A210.80.01

- Saladbar kapasite; 11 adet 1/4-100 Gn küvet.

TECHNICAL SPECIFICATIONS

- 4 pieces 400x600 mm tray capacity on each cover.
- Working temperature; 0/+5 °C at tropical ambient temperature 43 °C
- 220-230V -1 +N 50-60 Hz electrical power.
- "CFC Free" R-134 A refrigerant gas.
- 40 kg/m³ density.
- Temperature and defrost controlled digital display.
- Automatic evaporation of water during defrosting.
- Cooling with fan.
- Ozone-friendly" 48 mm thickness polyurethane isolation.
- Self-closing doors at 45 degrees.
- Copper tube evaporator with aluminum fins.
- Stainless steel body.

AND.A160.80.01

- Saladbar capacity; 8 pieces 1/4-100 Gn container.

AND.A210.80.01

- Saladbar capacity; 11 pieces 1/4-100 Gn container.

Soğutma Ekipmanları Cooling Equipment

Granit Tablalı Saladbarlı Hazırlık Buzdolapları Granite Top Refrigerators with Saladbar

andora

CE



Kod Code	Ürün Adı Description	Ebatlar Dimension	Ağırlık Weight	Net Net	Güç Power	Kapasite Capacity
		a x b x c (mm)	(kg)	(m ³)	(kw)	(lt)
AND.A160.80.02	Granit Tablalı Saladbarlı Buzdolabı 2 Kapılı Granite Refrigerator 2 Doors+Saladbar	1600x800x1020/1520	315	18	0.29	300
AND.A210.80.02	Granit Tablalı Saladbarlı Buzdolabı 3 Kapılı Granite Refrigerator 3 Doors+Saladbar	2100x800x1020/1520	386	2.3	0.42	500

TEKNİK ÖZELLİKLER

- Her kapakta 4 adet 400x600 mm tepsi kapasitesi.
- Çalışma aralığı 0/+5 °C (tropikal 43 °C)
- 220-230V -1 +N 50-60 Hz elektrik gücü.
- "CFC Free" R-134 A soğutucu gaz.
- 40 kg/m³ yoğunluk.
- Sıcaklık ve defrost kontrollü dijital gösterge.
- Defrost esnasında otomatik su buharlaştırma.
- Fanlı soğutma.
- 48 mm kalınlığında "ozon dostu" poliüretan izolasyon.
- 45 derecede sabit kendiliğinden kapanan kapılar.
- Alüminyum panelli, bakır borulu evaporatör.
- Paslanmaz çelik gövde.

AND.A160.80.02

- Saladbar kapasite; 7 adet 1/4-100 Gn küvet.

AND.A210.80.02

- Saladbar kapasite; 9 adet 1/4-100 Gn küvet.

TECHNICAL SPECIFICATIONS

- 4 pieces 400x600 mm tray capacity on each cover.
- Working temperature; 0/+5 °C at tropical ambient temperature 43 °C
- 220-230V -1 +N 50-60 Hz electrical power.
- "CFC Free" R-134 A refrigerant gas.
- 40 kg/m³ density.
- Temperature and defrost controlled digital display.
- Automatic evaporation of water during defrosting.
- Cooling with fan.
- Ozone-friendly" 48 mm thickness polyurethane isolation.
- Self-closing doors at 45 degrees.
- Copper tube evaporator with aluminum fins.
- Stainless steel body.

AND.A160.80.02

- Saladbar capacity; 7 pieces 1/4-100 Gn container.

AND.A210.80.02

- Saladbar capacity; 9 pieces 1/4-100 Gn container.

- Standart üretimimizde küvet bulunmamaktadır. / Standart product does not have containers.



Pres Baskı Raf Sistemi
Press Rack System



Kod Code	Ürün Adı Description	Ebatlar Dimension	Ağırlık Weight	Net Net	Güç Power	Kapasite Capacity
		a x b x c (mm)	(kg)	(m ³)	(kw)	(lt)
AND.A70.80.01	Dik Tip Buzdolabı Tek Kapılı Upright Refrigerator Single Door	700x800x2050	135	1.2	0.14	700
AND.A140.80.01	Dik Tip Buzdolabı Çift Kapılı Upright Refrigerator Double Doors	1400x800x2050	220	2.4	0.26	1400

TEKNİK ÖZELLİKLER

- Çalışma aralığı 0/+5 °C (tropikal 43 °C)
- 220-230V -1 +N 50-60 Hz elektrik gücü.
- "CFC Free" R-134 A soğutucu gaz.
- 40 kg/m³ yoğunluk.
- Sıcaklık ve defrost kontrollü dijital gösterge.
- Defrost esnasında otomatik su buharlaştırma.
- Fanlı soğutma.
- 48 mm kalınlığında "ozon dostu" poliüretan izolasyon.
- 45 derecede sabit kendiliğinden kapanan kapılar.
- Alüminyum panelli,bakır borulu evaporatör.
- Paslanmaz çelik gövde.

AND.A70.80.01

- 3 adet 2/1 Gn iç raf.

AND.A140.80.01

- 6 adet 2/1 Gn iç raf.

TECHNICAL SPECIFICATIONS

- Working temperature; 0/+5 °C at tropical ambient temperature 43 °C
- 220-230V -1 +N 50-60 Hz electrical power.
- "CFC Free" R-134 A refrigerant gas.
- 40 kg/m³ density.
- Temperature and defrost controlled digital display.
- Automatic evaporation of water during defrosting.
- Cooling with fan.
- "Ozone-friendly" 48 mm thickness polyurethane isolation.
- Self-closing doors at 45 degrees.
- Copper tube evaporator with aluminum fins.
- Stainless steel body.

AND.A70.80.01

- 3 pieces 2/1 Gn interior shelves.

AND.A140.80.01

- 6 pieces 2/1 Gn interior shelves.



Monoblok Soğutma Sistemi
Monoblock Cooling System



Led Aydınlatma
Led Lighting



Kilitli Kapılar
Locked Doors

Soğutma Ekipmanları Cooling Equipment

Camlı Dik Tip Buzdolapları (Fanlı Soğutma) Upright Refrigerators with Glass (Fan Cooling)

andora

CE



Pres Baskı Raf Sistemi
Press Rack System



Kod Code	Ürün Adı Description	Ebatlar Dimension	Ağırlık Weight	Net Net	Güç Power	Kapasite Capacity
		a x b x c (mm)	(kg)	(m ³)	(kw)	(lt)
AND.A70.80.03	Cam Kapı Dik Tip Buzdolabı Tek Kapılı Upright Refrigerator Single Door with Glass	700x800x2050	155	1.2	0.16	700
AND.A140.80.03	Cam Kapı Dik Tip Buzdolabı Çift Kapılı Upright Refrigerator Double Doors with Glass	1400x800x2050	230	2.4	0.30	1400

TEKNİK ÖZELLİKLER

- Çalışma aralığı 0/+5 °C (tropikal 43 °C)
- 220-230V -1 +N 50-60 Hz elektrik gücü.
- "CFC Free" R-134 A soğutucu gaz.
- 40 kg/m³ yoğunluk.
- Sıcaklık ve defrost kontrollü dijital gösterge.
- Defrost esnasında otomatik su buharlaştırma.
- Fanlı soğutma.
- 48 mm kalınlığında "ozon dostu" poliüretan izolasyon.
- 45 derecede sabit kendiliğinden kapanan kapılar.
- Alüminyum panelli, bakır borulu evaporatör.
- Paslanmaz çelik gövde.

AND.A70.80.03

- 3 adet 2/1 Gn iç raf.

AND.A140.80.03

- 6 adet 2/1 Gn iç raf.

TECHNICAL SPECIFICATIONS

- Working temperature; 0/+5 °C at tropical ambient temperature 43 °C
- 220-230V -1 +N 50-60 Hz electrical power.
- "CFC Free" R-134 A refrigerant gas.
- 40 kg/m³ density.
- Temperature and defrost controlled digital display.
- Automatic evaporation of water during defrosting.
- Cooling with fan.
- Ozone-friendly" 48 mm thickness polyurethane isolation.
- Self-closing doors at 45 degrees.
- Copper tube evaporator with aluminum fins.
- Stainless steel body.

AND.A70.80.03

- 3 pieces 2/1 Gn interior shelves.

AND.A140.80.03

- 6 pieces 2/1 Gn interior shelves.



Monoblok Soğutma Sistemi
Monoblock Cooling System



Kilitli Kapılar
Locked Doors

Pres Baskı Raf Sistemi
 Press Rack System

Kod Code	Ürün Adı Description	Ebatlar Dimension	Ağırlık Weight	Net Net	Güç Power	Kapasite Capacity
		a x b x c (mm)	(kg)	(m ³)	(kw)	(lt)
AND.A70.80.02	Dik Tip Derin Dondurucu 2 Kapılı Upright Deep Freezers 2 Doors	700x800x2050	151	1.2	0.69	700
AND.A140.80.02	Dik Tip Derin Dondurucu 4 Kapılı Upright Deep Freezers 4 Doors	1400x800x2050	245	2.4	1.20	1400

TEKNİK ÖZELLİKLER

- Çalışma aralığı -18/-20 °C
- 220-230V -1 +N 50-60 Hz elektrik gücü.
- "CFC Free" R-290 soğutucu gaz.
- 40 kg/m³ yoğunluk.
- Sıcaklık ve defrost kontrollü dijital gösterge.
- Defrost esnasında otomatik su buharlaştırma.
- Fanlı soğutma.
- 48 mm kalınlığında "ozon dostu" poliüretan izolasyon.
- 45 derecede sabit kendiliğinden kapanan kapılar.
- Alüminyum panelli,bakır borulu evaporatör.
- Paslanmaz çelik gövde.

AND.A70.80.02

- 3 adet 2/1 Gn iç raf.

AND.A140.80.02

- 6 adet 2/1 Gn iç raf.

TECHNICAL SPECIFICATIONS

- Working temperature; -18/-20 °C
- 220-230V -1 +N 50-60 Hz electrical power.
- "CFC Free" R-290 refrigerant gas.
- 40 kg/m³ density.
- Temperature and defrost controlled digital display.
- Automatic evaporation of water during defrosting.
- Cooling with fan.
- Ozone-friendly" 48 mm thickness polyurethane isolation.
- Self-closing doors at 45 degrees.
- Copper tube evaporator with aluminum fins.
- Stainless steel body.

AND.A70.80.02

- 3 pieces 2/1 Gn interior shelves.

AND.A140.80.02

- 6 pieces 2/1 Gn interior shelves.

Monoblok Soğutma Sistemi
 Monoblock Cooling System

Led Aydınlatma
 Led Lighting

Soğutma Ekipmanları Cooling Equipment

Dik Tip Pastane Buzdolapları (Fanlı Soğutma) Upright Patisserie Refrigerators (Fan Cooling)

andora

CE



Pres Baskı Raf Sistemi
Press Rack System



Kod Code	Ürün Adı Description	Ebatlar Dimension	Ağırlık Weight	Net Net	Güç Power	Kapasite Capacity
		a x b x c (mm)	(kg)	(m ³)	(kw)	(Tepsi/Tray)
AND.A70.95.01-40	Dik Tip Pastane Buzdolabı Tek Kapılı Upright Patisserie Refrigerator Single Door	700x950x2050	150	1.5	0.16	40

TEKNİK ÖZELLİKLER

- 40 kat 400x600 mm tepsi kapasitesi.
- Çalışma aralığı 0/+5 °C (tropikal 43 °C)
- 220-230V -1 +N 50-60 Hz elektrik gücü.
- "CFC Free" R-134 A soğutucu gaz.
- 40 kg/m³ yoğunluk.
- Sıcaklık ve defrost kontrollü dijital gösterge.
- Defrost esnasında otomatik su buharlaştırma.
- Fanlı soğutma.
- 48 mm kalınlığında "ozon dostu" poliüretan izolasyon.
- 45 derecede sabit kendiliğinden kapanan kapılar.
- Alüminyum panelli, bakır borulu evaporatör.
- Paslanmaz çelik gövde.

TECHNICAL SPECIFICATIONS

- 40 layers 400x600 mm tray capacity.
- Working temperature; 0/+5 °C at tropical ambient temperature 43 °C
- 220-230V -1 +N 50-60 Hz electrical power.
- "CFC Free" R-134 A refrigerant gas.
- 40 kg/m³ density.
- Temperature and defrost controlled digital display.
- Automatic evaporation of water during defrosting.
- Cooling with fan.
- Ozone-friendly" 48 mm thickness polyurethane isolation.
- Self-closing doors at 45 degrees.
- Copper tube evaporator with aluminum fins.
- Stainless steel body.



Monoblok Soğutma Sistemi
Monoblock Cooling System



Led Aydınlatma
Led Lighting



Kilitli Kapılar
Locked Doors

Pres Baskı Raf Sistemi
 Press Rack System

Kod Code	Ürün Adı Description	Ebatlar Dimension	Ağırlık Weight	Net Net	Güç Power	Kapasite Capacity
		a x b x c (mm)	(kg)	(m ³)	(kw)	(Tepsi/Tray)
AND.A70.95.02-40	Dik Tip Pastane Derin Dondurucu Tek Kapılı Upright Patisserie Deep Freezer Single Door	700x950x2050	160	1.5	0.70	40

TEKNİK ÖZELLİKLER

- 40 kat 400x600 mm tepsi kapasitesi.
- Çalışma aralığı, -18/-20 °C
- 220-230V -1 +N 50-60 Hz elektrik gücü.
- "CFC Free" R-290 soğutucu gaz.
- 40 kg/m³ yoğunluk.
- Sıcaklık ve defrost kontrollü dijital gösterge.
- Defrost esnasında otomatik su buharlaştırma.
- Fanlı soğutma.
- 48 mm kalınlığında "ozon dostu" poliüretan izolasyon.
- 45 derecede sabit kendiliğinden kapanan kapılar.
- Alüminyum panelli, bakır borulu evaporatör.
- Paslanmaz çelik gövde.

TECHNICAL SPECIFICATIONS

- 40 layers 400x600 mm tray capacity.
- Working temperature; -18/-20 °C
- 220-230V -1 +N 50-60 Hz electrical power.
- "CFC Free" R-290 refrigerant gas.
- 40 kg/m³ density.
- Temperature and defrost controlled digital display.
- Automatic evaporation of water during defrosting.
- Cooling with fan.
- Ozone-friendly" 48 mm thickness polyurethane isolation.
- Self-closing doors at 45 degrees.
- Copper tube evaporator with aluminum fins.
- Stainless steel body.

Monoblok Soğutma Sistemi
 Monoblock Cooling System

Led Aydınlatma
 Led Lighting

Kilitli Kapılar
 Locked Doors

Soğutma Ekipmanları Cooling Equipment

Dik Tip Pastane Buzdolapları (Fanlı Soğutma) Upright Patisserie Refrigerators (Fan Cooling)

andora

CE

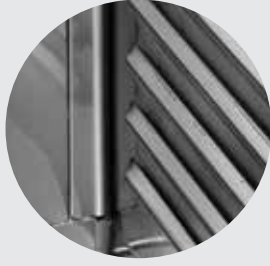

Pres Baskı Raf Sistemi
Press Rack System



Kod Code	Ürün Adı Description	Ebatlar Dimension a x b x c (mm)	Ağırlık Weight (kg)	Net Net (m ³)	Güç Power (kw)	Kapasite Capacity (lt)
AND.A70.95.01	Dik Tip Pastane Buzdolabı Tek Kapılı Upright Patisserie Refrigerator Single Door	700x800x2050	142	1.2	0.69	700
AND.A140.95.01	Dik Tip Pastane Buzdolabı Çift Kapılı Upright Patisserie Refrigerator Double Doors	1400x800x2050	220	2.4	0.26	1400

TEKNİK ÖZELLİKLER

- Çalışma aralığı 0/+5 °C (tropikal 43 °C)
- 220-230V -1 +N 50-60 Hz elektrik gücü.
- "CFC Free" R-134 A soğutucu gaz.
- 40 kg/m³ yoğunluk.
- Sıcaklık ve defrost kontrollü dijital gösterge.
- Defrost esnasında otomatik su buharlaştırma.
- Fanlı soğutma.
- 48 mm kalınlığında "ozon dostu" poliüretan izolasyon.
- 45 derecede sabit kendiliğinden kapanan kapılar.
- Alüminyum panelli, bakır borulu evaporatör.
- Paslanmaz çelik gövde.

AND.A70.95.01

- Kapasite; 20 adet 40x60 tepsi.

AND.A140.95.01

- Kapasite; 2x20 adet 40x60 tepsi.

TECHNICAL SPECIFICATIONS

- Working temperature; 0/+5 °C at tropical ambient temperature 43 °C
- 220-230V -1 +N 50-60 Hz electrical power.
- "CFC Free" R-134 A refrigerant gas.
- 40 kg/m³ density.
- Temperature and defrost controlled digital display.
- Automatic evaporation of water during defrosting.
- Cooling with fan.
- Ozone-friendly" 48 mm thickness polyurethane isolation.
- Self-closing doors at 45 degrees.
- Copper tube evaporator with aluminum fins.
- Stainless steel body.

AND.A70.95.01

- Capacity: 20 pieces 40x60 trays

AND.A140.95.01

- Capacity: 2x20 pieces 40x60 trays



Monoblok Soğutma Sistemi
Monoblock Cooling System



Led Aydınlatma
Led Lighting



Kilitli Kapılar
Locked Doors

Pres Baskı Raf Sistemi
 Press Rack System

Kod Code	Ürün Adı Description	Ebatlar Dimension	Ağırlık Weight	Net Net	Güç Power	Kapasite Capacity
		a x b x c (mm)	(kg)	(m ³)	(kw)	(lt)
AND.A70.95.02	Dik Tip Pastane Derin Dondurucu Tek Kapılı Upright Patisserie Deep Freezer Single Door	700x800x2050	163	1.2	0.69	700
AND.A140.95.02	Dik Tip Pastane Derin Dondurucu Çift Kapılı Upright Patisserie Deep Freezer Double Doors	1400x800x2050	240	2.4	1.20	1400

TEKNİK ÖZELLİKLER

- Çalışma aralığı -18/-20 °C
- 220-230V -1 +N 50-60 Hz elektrik gücü.
- "CFC Free" R-290 soğutucu gaz.
- 40 kg/m³ yoğunluk.
- Sıcaklık ve defrost kontrollü dijital gösterge.
- Defrost esnasında otomatik su buharlaştırma.
- Fanlı soğutma.
- 48 mm kalınlığında "ozon dostu" poliüretan izolasyon.
- 45 derecede sabit kendiliğinden kapanan kapılar.
- Alüminyum panelli,bakır borulu evaporatör.
- Paslanmaz çelik gövde.

AND.A70.95.02

- Kapasite; 20 adet 40x60 tepsi.

AND.A140.95.02

- Kapasite; 2x20 adet 40x60 tepsi.

TECHNICAL SPECIFICATIONS

- Working temperature; -18/-20 °C
- 220-230V -1 +N 50-60 Hz electrical power.
- "CFC Free" R-290 refrigerant gas.
- 40 kg/m³ density.
- Temperature and defrost controlled digital display.
- Automatic evaporation of water during defrosting.
- Cooling with fan.
- Ozone-friendly" 48 mm thickness polyurethane isolation.
- Self-closing doors at 45 degrees.
- Copper tube evaporator with aluminum fins.
- Stainless steel body.

AND.A70.95.02

- Capacity; 20 pieces 40x60 trays

AND.A140.95.02

- Capacity; 2x20 pieces 40x60 trays

Monoblok Soğutma Sistemi
 Monoblock Cooling System

Led Aydınlatma
 Led Lighting

Kilitli Kapılar
 Locked Doors



Teşhir Ürünleri Display Products



andora

andora

TEŞHİR ÜRÜNLERİ

Soğutmalı Salat Bar
Sıcak Benmariler
Nötr Salat Bar
Benmari ve Nötr Servis Üniteleri
Benmari Servis Üniteleri
Benmari Servis Ünite Aksesuarları
Soğuk Servis Üniteleri (Fanlı Soğutma)
Soğuk Servis Ünite Aksesuarları
Soğuk Servis Üniteleri (Fanlı Soğutma)
Soğuk Servis Ünite Aksesuarları
Ocakbaşı (Davlumbazlı)
Ocakbaşı Aksesuarları
Kömürlü Izgaralar
Nötr Servis Üniteleri
Nötr Servis Ünite Aksesuarları
Köşe Servis ve Küver Üniteleri
Köşe Tezgahları ve Küver Ünite Aksesuarları
Merkür Et ve Meze Vitrinleri (Bombe Camlı)
Merkür Et ve Meze Vitrinleri (Düz Camlı)
Plüton Et ve Meze Teşhir Vitrinleri (Düz Camlı)
Plüton Et ve Meze Teşhir Vitrinleri (Bombe Camlı)
Neptün Pasta Vitrinleri (Soğutmalı)
Neptün Pasta Vitrinleri (Nötr)
Neptün Pasta Vitrinleri (Isıtmalı)
Venüs Pasta Vitrinleri (Soğutmalı)
Venüs Pasta Vitrinleri (Nötr)
Venüs Pasta Vitrinleri (Isıtmalı)

DISPLAY PRODUCTS

Cold Buffet Salad Bar
Hot Buffets
Neutral Buffet Salad Bar
Bainmarie and Neutral Service Units
Bainmarie Service Units
Bainmarie Service Unit Accessories
Cold Service Units (Fan Cooling)
Cold Service Unit Accessories
Cold Service Units (Fan Cooling)
Cold Service Unit Accessories
Display Type Grills (with Hood)
Display Type Grill Accessories
Charcoal Grills
Neutral Service Units
Neutral Service Unit Accessories
Corner Service and Cutlery Units
Corner Service Tables and Cutlery Unit Accessories
Mercury Meat and Appetizer Showcases (Convex Glass)
Mercury Meat and Appetizer Showcases (Flat Glass)
Pluton Meat and Apettizer Showcase (Flat Glass)
Pluton Meat and Apettizer Showcase (Convex Glass)
Neptun Pastry Showcase (with Cooling)
Neptun Pastry Showcase (Neutral)
Neptun Pastry Showcase (with Heating)
Venus Pastry Showcase (with Cooling)
Venus Pastry Showcase (Neutral)
Venus Pastry Showcase (with Heating)



Kod Code	Ürün Adı Description	Ebatlar Dimension	Ağırlık Weight	Net Net	Güç Power	Kapasite Capacity
		a x b x c (mm)	(kg)	(m ³)	(kw)	(gn)
AND.SB.03	Soğutmalı Salat Bar Cold Buffet Salad Bar	1180x890x870/1370	125	1.43	1.3	3x1/1 Gn
AND.SB.04	Soğutmalı Salat Bar Cold Buffet Salad Bar	1500x890x870/1370	146	1.82	1.3	4x1/1 Gn
AND.SB.05	Soğutmalı Salat Bar Cold Buffet Salad Bar	1800x890x870/1370	163	2.19	1.3	5x1/1 Gn
AND.SB.06	Soğutmalı Salat Bar Cold Buffet Salad Bar	2100x890x870/1370	184	2.50	1.3	6x1/1 Gn

TEKNİK ÖZELLİKLER

- Paslanmaz çelik havuz.
- 220V 50Hz enerji.
- Serpantin soğutma sistemi.
- 40 kg/m³ yoğunluk poliüretan izolasyon.
- Aydınlatma Sistemi.
- R-134 A soğutucu gaz.
- Opsiyonel ahşap gövde.
- Çıkartılabilir üst servis rafı.

TECHNICAL SPECIFICATIONS

- Stainless steel well.
- 220V 50Hz energy.
- Serpentine cooling system.
- 40 kg/m³ density polyurathane isolation.
- Lightining system.
- Refrigerant gas: R-134 A
- Optional wooden body colour.
- Removable glass sneeze guard shield.

- R-290 Soğutucu Gaz Tipi için %3 fiyat farkı ekleyiniz. / Please add %3 price difference for R-290 refrigerant gas.
- Standart üretimimizde küvet bulunmamaktadır. / Standart product does not have containers.

Renk Seçenekleri
Color Options**Fındık
Hazelnut**

Renk Kodları
Color Codes
AND.SB.03.F
AND.SB.04.F
AND.SB.05.F
AND.SB.06.F

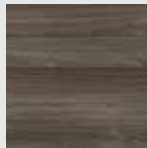
**Kül Meşe
Ash Oak**

Renk Kodları
Color Codes
AND.SB.03.K
AND.SB.04.K
AND.SB.05.K
AND.SB.06.K

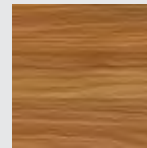
**Samba Ceviz
Samba Walnut**

Renk Kodları
Color Codes
AND.SB.03.S
AND.SB.04.S
AND.SB.05.S
AND.SB.06.S

* Lütfen, Siparişlerinizde ürün renk kodunu belirtiniz.
* Please, Specify colour code on order.

Sıcak Benmariler

Hot Buffets

andora

CE



Kod Code	Ürün Adı Description	Ebatlar Dimension	Ağırlık Weight	Net Net	Güç Power	Kapasite Capacity
		a x b x c (mm)	(kg)	(m ³)	(kw)	(gn)
AND.SBS.03	Sıcak Benmari Hot Buffet	1180x890x870/1370	125	1.43	3.6	3x1/1
AND.SBS.04	Sıcak Benmari Hot Buffet	1500x890x870/1370	146	1.82	3.6	4x1/1
AND.SBS.05	Sıcak Benmari Hot Buffet	1800x890x870/1370	163	2.19	3.5	5x1/1
AND.SBS.06	Sıcak Benmari Hot Buffet	2100x890x870/1370	184	2.50	3.5	6x1/1

TEKNİK ÖZELLİKLER

- Termostatik kumanda.
- 220V 50 Hz enerji.
- Paslanmaz çelik havuz.
- Su tahliye vanası.
- Aydınlatma Sistemi.
- Opsiyonel ahşap gövde.
- Çıkarılabilir üst servis rafı.

TECHNICAL SPECIFICATIONS

- Thermostatic control.
- Power: 220V 50 Hz
- Stainless steel well.
- Water drainage valve.
- Lightining system.
- Optional wooden body colour.
- Removable glass sneeze guard shield.

Standart üretimimizde küvet bulunmamaktadır. / Standart product does not have containers.

Renk Seçenekleri Color Options



**Fındık
Hazelnut**

Renk Kodları
Color Codes
AND.SBS.03.F
AND.SBS.04.F
AND.SBS.05.F
AND.SBS.06.F



**Kül Meşe
Ash Oak**

Renk Kodları
Color Codes
AND.SBS.03.K
AND.SBS.04.K
AND.SBS.05.K
AND.SBS.06.K

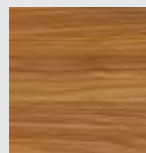

**Samba Ceviz
Samba Walnut**

Renk Kodları
Color Codes
AND.SBS.03.S
AND.SBS.04.S
AND.SBS.05.S
AND.SBS.06.S

* Lütfen, Siparişlerinizde ürün renk kodunu belirtiniz.

* Please, Specify colour code on order.



Kod Code	Ürün Adı Description	Ebatlar Dimension	Ağırlık Weight	Net Net
		a x b x c (mm)	(kg)	(m ³)
AND.SB.03-N	Nötr Salat Bar Neutral Buffet Salad Bar	1180x890x870/1370	125	1.43
AND.SB.04-N	Nötr Salat Bar Neutral Buffet Salad Bar	1500x890x870/1370	146	1.82
AND.SB.05-N	Nötr Salat Bar Neutral Buffet Salad Bar	1800x890x870/1370	163	2.19
AND.SB.06-N	Nötr Salat Bar Neutral Buffet Salad Bar	2100x890x870/1370	184	2.50

TEKNİK ÖZELLİKLER

- Granit üst tabla.
- Aydınlatma Sistemi.
- Opsiyonel ahşap gövde.
- Çıkarılabilir üst servis rafı.

TECHNICAL SPECIFICATIONS

- Granite table top.
- Lightining system.
- Optional wooden body colour.
- Removable glass sneeze guard shield.

Renk Seçenekleri
Color OptionsFındık
Hazelnut

Renk Kodları
Color Codes
AND.SB.03-N-F
AND.SB.04-N-F
AND.SB.05-N-F
AND.SB.06-N-F

Kül Meşe
Ash Oak

Renk Kodları
Color Codes
AND.SB.03-N-K
AND.SB.04-N-K
AND.SB.05-N-K
AND.SB.06-N-K

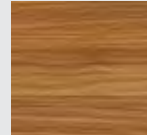
Samba Ceviz
Samba Walnut

Renk Kodları
Color Codes
AND.SB.03-N-S
AND.SB.04-N-S
AND.SB.05-N-S
AND.SB.06-N-S

* Lütfen, Siparişlerinizde ürün renk kodunu belirtiniz.
* Please, Specify colour code on order.

Teşhir Ürünleri
Display Products





Standart üretimimizde küvet bulunmamaktadır. / Standart product does not have containers.

Kod Code	Ürün Adı Description	Ebatlar Dimension a x b x c (mm)	Ağırlık Weight (kg)	Net Net (m ³)	Kapasite Capacity (1/1 Gn)
AND.ABEN.31	Servis Ünitesi Üst Rafı Sürgü Standlı Service Unit Top Shelf Sliding Tray	1500x790x850/1350	99	1.5	3 Sıcak+1 Nötr 3 Hot+1 Neutral
AND.ABEN.41	Servis Ünitesi Üst Rafı Sürgü Standlı Service Unit Top Shelf Sliding Tray	1800x790x850/1350	118	1.8	4 Sıcak+1 Nötr 4 Hot+1 Neutral
AND.ABEN.31.AD	Servis Ünitesi Üst Rafı Sürgü Standlı Ahşap Service Unit Top Shelf Sliding Tray Wooden	1500x790x850/1350	99	1.5	3 Sıcak+1 Nötr 3 Hot+1 Neutral
AND.ABEN.41.AD	Servis Ünitesi Üst Rafı Sürgü Standlı Ahşap Service Unit Top Shelf Sliding Tray Wooden	1800x790x850/1350	118	1.8	4 Sıcak+1 Nötr 4 Hot+1 Neutral
AND.ABKU.10	Küver Ünitesi Service Plate Unit	800x790x850/1350	75	0.8	2/1 150 Gn
AND.ABKU.10.AH	Küver Ünitesi Ahşap Dekorlu Service Plate Unit Wooden Decorated	800x790x850/1350	75	0.8	

TEKNİK ÖZELLİKLER

- Termostatik kumanda.
- 220V 50 Hz enerji.
- Paslanmaz çelik havuz.
- Su tahliye vanası.
- Aydınlatma Sistemi.
- Opsiyonel ön ahşap giydirme.
- Paslanmaz çelik gövde.

TECHNICAL SPECIFICATIONS

- Thermostatic control.
- Power: 220V 50 Hz
- Stainless steel well.
- Water drainage valve.
- Lightining system.
- Optional wooden front surface.
- Stainless steel body.

Renk Seçenekleri
Color Options



Açık Eskieme
Light Brown

Renk Kodları
Color Codes
AND.ABEN.31.AD.A
AND.ABEN.41.AD.A
AND.ABKU.10.AH.A

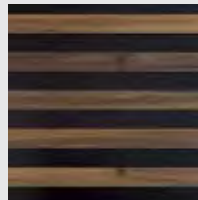

Koyu Eskieme
Dark Brown

Renk Kodları
Color Codes
AND.ABEN.31.AD.K
AND.ABEN.41.AD.K
AND.ABKU.10.AH.K

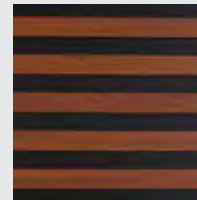

Mahon
Rusty

Renk Kodları
Color Codes
AND.ABEN.31.AD.M
AND.ABEN.41.AD.M
AND.ABKU.10.AH.M

* Lütfen, Siparişlerinizde ürün renk kodunu belirtiniz.
* Please, Specify colour code on order.

Benmari Servis Üniteleri

Bainmarie Service Units

andora

CE



Kod Code	Ürün Adı Description	Ebatlar Dimension	Ağırlık Weight	Net Net	Güç Power	Kapasite Capacity
		a x b x c (mm)	(kg)	(m ³)	(kw)	(gn)
AND.ABEH.05	Benmari Servis Ünitesi Bainmarie Service Unit	800x790x850	40	0.55	3.6	2x1/1 Gn
AND.ABEH.10	Benmari Servis Ünitesi Bainmarie Service Unit	1250x790x850	67	0.8	3.6	3x1/1 Gn
AND.ABEH.30	Benmari Servis Ünitesi Bainmarie Service Unit	1500x790x850	79	0.95	3.5	4x1/1 Gn
AND.ABEH.50	Benmari Servis Ünitesi Bainmarie Service Unit	1800x790x850	95	1.2	3.5	5x1/1 Gn
AND.ABEH.70	Benmari Servis Ünitesi Bainmarie Service Unit	2100x790x850	157	1.3	7.2	6x1/1 Gn

TEKNİK ÖZELLİKLER

- Termostatik kumanda.
- 220V 50 Hz enerji.
- Paslanmaz çelik havuz.
- Su tahliye vanası.
- Led aydınlatma.
- Opsiyonel ön ahşap giydirme.
- Paslanmaz çelik gövde.

TECHNICAL SPECIFICATIONS

- Thermostatic control.
- Power: 220V 50 Hz
- Stainless steel well.
- Water drainage valve.
- Led lighting.
- Optional wooden front surface.
- Stainless steel body.

Standart üretimimizde küvet bulunmamaktadır.
Standart product does not have containers.

* Lütfen, Siparişlerinizde ürün renk kodunu belirtiniz. / Please, Specify colour code on order.

Kod Code	Ürün Adı Description
-------------	-------------------------

AND.ABEH.05.AD.A Açık Eskitme Ahşap Dekor / Light Brown Wooden Decorated

AND.ABEH.10.AD.A Açık Eskitme Ahşap Dekor / Light Brown Wooden Decorated

AND.ABEH.30.AD.A Açık Eskitme Ahşap Dekor / Light Brown Wooden Decorated

AND.ABEH.50.AD.A Açık Eskitme Ahşap Dekor / Light Brown Wooden Decorated

AND.ABEH.70.AD.A Açık Eskitme Ahşap Dekor / Light Brown Wooden Decorated

Kod Code	Ürün Adı Description
-------------	-------------------------

AND.ABEH.05.AD.K Koyu Eskitme Ahşap Dekor / Dark Brown Wooden Decorated

AND.ABEH.10.AD.K Koyu Eskitme Ahşap Dekor / Dark Brown Wooden Decorated

AND.ABEH.30.AD.K Koyu Eskitme Ahşap Dekor / Dark Brown Wooden Decorated

AND.ABEH.50.AD.K Koyu Eskitme Ahşap Dekor / Dark Brown Wooden Decorated

AND.ABEH.70.AD.K Koyu Eskitme Ahşap Dekor / Dark Brown Wooden Decorated

Kod Code	Ürün Adı Description
-------------	-------------------------

AND.ABEH.05.AD.M Mahon Ahşap Dekor / Rusty Wooden Decorated

AND.ABEH.10.AD.M Mahon Ahşap Dekor / Rusty Wooden Decorated

AND.ABEH.30.AD.M Mahon Ahşap Dekor / Rusty Wooden Decorated

AND.ABEH.50.AD.M Mahon Ahşap Dekor / Rusty Wooden Decorated

AND.ABEH.70.AD.M Mahon Ahşap Dekor / Rusty Wooden Decorated

Kod Code	Ürün Adı Description
-------------	-------------------------

AND.ABEH.05.GT Granit Tabla (Standart Granit-Star Galaxy) / Standard Granite-Star Galaxy

AND.ABEH.10.GT Granit Tabla (Standart Granit-Star Galaxy) / Standard Granite-Star Galaxy

AND.ABEH.30.GT Granit Tabla (Standart Granit-Star Galaxy) / Standard Granite-Star Galaxy

AND.ABEH.50.GT Granit Tabla (Standart Granit-Star Galaxy) / Standard Granite-Star Galaxy

AND.ABEH.70.GT Granit Tabla (Standart Granit-Star Galaxy) / Standard Granite-Star Galaxy

Kod Code	Ürün Adı Description
-------------	-------------------------

AND.ABEH.05.TK Tepsi Kaydırma Standı / Tray Sliding Stand

AND.ABEH.10.TK Tepsi Kaydırma Standı / Tray Sliding Stand

AND.ABEH.30.TK Tepsi Kaydırma Standı / Tray Sliding Stand

AND.ABEH.50.TK Tepsi Kaydırma Standı / Tray Sliding Stand

AND.ABEH.70.TK Tepsi Kaydırma Standı / Tray Sliding Stand

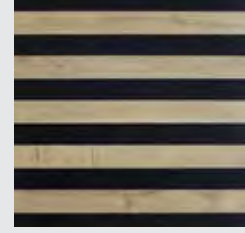
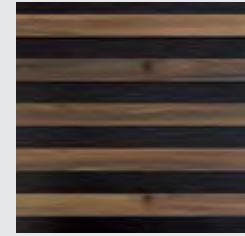
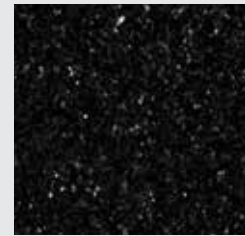
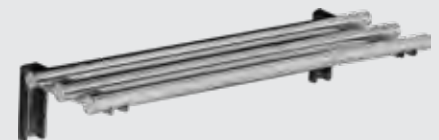
Açık Eskitme
Light BrownKoyu Eskitme
Dark BrownMahon
RustyStar Galaxy Granit
Star Galaxy Granite



Kod Code	Ürün Adı Description	Ebatlar Dimension
		a x b x c (mm)
AND.ABEH.05.USC.T	Üst Raf Grup Tam Cam Farkı Top Shelf Group Full Glass Difference	800x375x440
AND.ABEH.10.USC.T	Üst Raf Grup Tam Cam Farkı Top Shelf Group Full Glass Difference	1250x375x440
AND.ABEH.30.USC.T	Üst Raf Grup Tam Cam Farkı Top Shelf Group Full Glass Difference	1500x375x440
AND.ABEH.50.USC.T	Üst Raf Grup Tam Cam Farkı Top Shelf Group Full Glass Difference	1800x375x440
AND.ABEH.70.USC.T	Üst Raf Grup Tam Cam Farkı Top Shelf Group Full Glass Difference	2100x375x440



Kod Code	Ürün Adı Description	Ebatlar Dimension
		a x b x c (mm)
AND.ABEH.05.USC.Y	Üst Raf Grup Yarım Cam Farkı Top Shelf Group Half Glass Difference	800x375x440
AND.ABEH.10.USC.Y	Üst Raf Grup Yarım Cam Farkı Top Shelf Group Half Glass Difference	1250x375x440
AND.ABEH.30.USC.Y	Üst Raf Grup Yarım Cam Farkı Top Shelf Group Half Glass Difference	1500x375x440
AND.ABEH.50.USC.Y	Üst Raf Grup Yarım Cam Farkı Top Shelf Group Half Glass Difference	1800x375x440
AND.ABEH.70.USC.Y	Üst Raf Grup Yarım Cam Farkı Top Shelf Group Half Glass Difference	2100x375x440



Kod Code	Ürün Adı Description	Ebatlar Dimension
		a x b x c (mm)
AND.ABEH.05.BC.T	Üst Grup Bombe Tam Cam Farkı Top Group Convex Full Glass Difference	800x640x440
AND.ABEH.10.BC.T	Üst Grup Bombe Tam Cam Farkı Top Group Convex Full Glass Difference	1250x640x440
AND.ABEH.30.BC.T	Üst Grup Bombe Tam Cam Farkı Top Group Convex Full Glass Difference	1500x640x440
AND.ABEH.50.BC.T	Üst Grup Bombe Tam Cam Farkı Top Group Convex Full Glass Difference	1800x640x440
AND.ABEH.70.BC.T	Üst Grup Bombe Tam Cam Farkı Top Group Convex Full Glass Difference	2100x640x440



Kod Code	Ürün Adı Description	Ebatlar Dimension
		a x b x c (mm)
AND.ABEH.05.BC.Y	Üst Grup Bombe Yarım Cam Farkı Top Group Convex Half Glass Difference	800x640x440
AND.ABEH.10.BC.Y	Üst Grup Bombe Yarım Cam Farkı Top Group Convex Half Glass Difference	1250x640x440
AND.ABEH.30.BC.Y	Üst Grup Bombe Yarım Cam Farkı Top Group Convex Half Glass Difference	1500x640x440
AND.ABEH.50.BC.Y	Üst Grup Bombe Yarım Cam Farkı Top Group Convex Half Glass Difference	1800x640x440
AND.ABEH.70.BC.Y	Üst Grup Bombe Yarım Cam Farkı Top Group Convex Half Glass Difference	2100x640x440

Soğuk Servis Üniteleri (Fanlı Soğutma)

Cold Service Units (Fan Cooling)

andora

CE



Kod Code	Ürün Adı Description	Ebatlar Dimension	Ağırlık Weight	Net Net	Güç Power	Kapasite Capacity
		a x b x c (mm)	(kg)	(m ³)	(kw)	(gn)
AND.ABSS.20	Soğuk Servis Ünitesi Cold Service Unit	1250x790x850	86	0.8	0.35	3x1/1
AND.ABSS.40	Soğuk Servis Ünitesi Cold Service Unit	1500x790x850	100	1	0.45	4x1/1
AND.ABSS.60	Soğuk Servis Ünitesi Cold Service Unit	2000x790x850	120	1.2	0.45	5x1/1
AND.ABSS.80	Soğuk Servis Ünitesi Buzdolaplı Cold Service Unit Refrigerated	2550x790x850	140	1.68	0.60	7x1/1

TEKNİK ÖZELLİKLER

- Çalışma aralığı 0/+5 °C (tropikal 43 °C)
- 220-230V -1 +N 50-60 Hz elektrik gücü.
- "CFC Free" R-134 A soğutucu gaz.
- 40 kg/m³ yoğunluk.
- Sıcaklık ve defrost kontrollü dijital gösterge.
- Defrost esnasında otomatik su buharlaştırma.
- Fanlı soğutma.
- 48 mm kalınlığında "ozon dostu" poliüretan izolasyon.
- 45 derecede sabit kendiliğinden kapanan kapılar.
- Alüminyum panelli,bakır borulu evaporatör.
- Ayarlanabilir, paslanmaz çelik raf yuvaları, plastik raflar.
- Paslanmaz çelik gövde.
- Opsiyonel ön ahşap giydirme.
- Led aydınlatma.
- Paslanmaz çelik gövde.

TECHNICAL SPECIFICATIONS

- Working temperature; 0/+5 °C at tropical ambient temperature 43 °C
- 220-230V -1 +N 50-60 Hz electrical power.
- "CFC Free" R-134 A refrigerant gas.
- 40 kg/m³ density.
- Temperature and defrost controlled digital display.
- Automatic evaporation of water during defrosting.
- Cooling with fan.
- Ozone-friendly" 48 mm thickness polyurethane isolation.
- Self-closing doors at 45 degrees.
- Copper tube evaporator with aluminum fins.
- Adjustable, stainless steel shelf housing, plastic coated shelves.
- Stainless steel body.
- Optional wooden front surface.
- Led lightining.
- Stainless steel body.

Standart üretimimizde küvet bulunmamaktadır. / Standart product does not have containers.
R-290 Soğutucu Gaz Tipi için %3 fiyat farkı ekleyiniz. / Please add %3 price difference for R-290 refrigerant gas.

* Lütfen, Siparişlerinizde ürün renk kodunu belirtiniz. / Please, Specify colour code on order.

Kod Code	Ürün Adı Description
-------------	-------------------------

AND.ABSS.20.AD.A Açık Eskieme Ahşap Dekor / Light Brown Wooden Decorated

AND.ABSS.40.AD.A Açık Eskieme Ahşap Dekor / Light Brown Wooden Decorated

AND.ABSS.60.AD.A Açık Eskieme Ahşap Dekor / Light Brown Wooden Decorated

AND.ABSS.80.AD.A Açık Eskieme Ahşap Dekor / Light Brown Wooden Decorated

Açık Eskieme
Light Brown

Kod Code	Ürün Adı Description
-------------	-------------------------

AND.ABSS.20.AD.K Koyu Eskieme Ahşap Dekor / Dark Brown Wooden Decorated

AND.ABSS.40.AD.K Koyu Eskieme Ahşap Dekor / Dark Brown Wooden Decorated

AND.ABSS.60.AD.K Koyu Eskieme Ahşap Dekor / Dark Brown Wooden Decorated

AND.ABSS.80.AD.K Koyu Eskieme Ahşap Dekor / Dark Brown Wooden Decorated

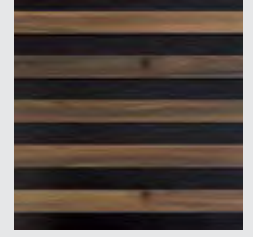
Koyu Eskieme
Dark Brown

Kod Code	Ürün Adı Description
-------------	-------------------------

AND.ABSS.20.AD.M Mahon Ahşap Dekor / Rusty Wooden Decorated

AND.ABSS.40.AD.M Mahon Ahşap Dekor / Rusty Wooden Decorated

AND.ABSS.60.AD.M Mahon Ahşap Dekor / Rusty Wooden Decorated

AND.ABSS.80.AD.M Mahon Ahşap Dekor / Rusty Wooden Decorated

Mahon
Rusty

Kod Code	Ürün Adı Description
-------------	-------------------------

AND.ABSS.20.GT Granit Tabla (Standart Granit-Star Galaxy) / Standard Granite-Star Galaxy

AND.ABSS.40.GT Granit Tabla (Standart Granit-Star Galaxy) / Standard Granite-Star Galaxy

AND.ABSS.60.GT Granit Tabla (Standart Granit-Star Galaxy) / Standard Granite-Star Galaxy

AND.ABSS.80.GT Granit Tabla (Standart Granit-Star Galaxy) / Standard Granite-Star Galaxy

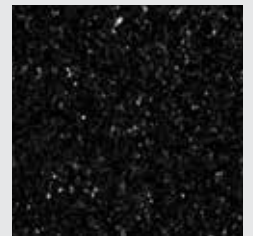
Star Galaxy Granit
Star Galaxy Granite

Kod Code	Ürün Adı Description
-------------	-------------------------

AND.ABSS.20.TK Tepsi Kaydırma Standı / Tray Sliding Stand

AND.ABSS.40.TK Tepsi Kaydırma Standı / Tray Sliding Stand

AND.ABSS.60.TK Tepsi Kaydırma Standı / Tray Sliding Stand

AND.ABSS.80.TK Tepsi Kaydırma Standı / Tray Sliding Stand

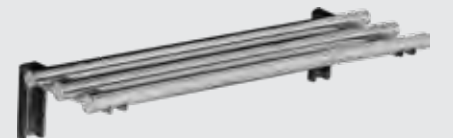



Kod Code	Ürün Adı Description	Ebatlar Dimension
		a x b x c (mm)
AND.ABSS.20.USC.T	Üst Raf Grup Tam Cam Farkı Top Shelf Group Full Glass Difference	1250x375x440
AND.ABSS.40.USC.T	Üst Raf Grup Tam Cam Farkı Top Shelf Group Full Glass Difference	1500x375x440
AND.ABSS.60.USC.T	Üst Raf Grup Tam Cam Farkı Top Shelf Group Full Glass Difference	2000x375x440
AND.ABSS.80.USC.T	Üst Raf Grup Tam Cam Farkı Top Shelf Group Full Glass Difference	2550x375x440



Kod Code	Ürün Adı Description	Ebatlar Dimension
		a x b x c (mm)
AND.ABSS.20.USC.Y	Üst Raf Grup Yarım Cam Farkı Top Shelf Group Half Glass Difference	1250x375x440
AND.ABSS.40.USC.Y	Üst Raf Grup Yarım Cam Farkı Top Shelf Group Half Glass Difference	1500x375x440
AND.ABSS.60.USC.Y	Üst Raf Grup Yarım Cam Farkı Top Shelf Group Half Glass Difference	2000x375x440
AND.ABSS.80.USC.Y	Üst Raf Grup Yarım Cam Farkı Top Shelf Group Half Glass Difference	2550x375x440



Kod Code	Ürün Adı Description	Ebatlar Dimension
		a x b x c (mm)
AND.ABSS.20.BC.T	Üst Grup Bombe Tam Cam Farkı Top Group Convex Full Glass Difference	1250x640x440
AND.ABSS.40.BC.T	Üst Grup Bombe Tam Cam Farkı Top Group Convex Full Glass Difference	1500x640x440
AND.ABSS.60.BC.T	Üst Grup Bombe Tam Cam Farkı Top Group Convex Full Glass Difference	2000x640x440
AND.ABSS.80.BC.T	Üst Grup Bombe Tam Cam Farkı Top Group Convex Full Glass Difference	2550x640x440



Kod Code	Ürün Adı Description	Ebatlar Dimension
		a x b x c (mm)
AND.ABSS.20.BC.Y	Üst Grup Bombe Yarım Cam Farkı Top Group Convex Half Glass Difference	1250x640x440
AND.ABSS.40.BC.Y	Üst Grup Bombe Yarım Cam Farkı Top Group Convex Half Glass Difference	1500x640x440
AND.ABSS.60.BC.Y	Üst Grup Bombe Yarım Cam Farkı Top Group Convex Half Glass Difference	2000x640x440
AND.ABSS.80.BC.Y	Üst Grup Bombe Yarım Cam Farkı Top Group Convex Half Glass Difference	2550x640x440

Teşhir Ürünleri Display Products

Soğuk Servis Üniteleri (Fanlı Soğutma) Cold Service Units (Fan Cooling)

andora

CE



Kod Code	Ürün Adı Description	Ebatlar Dimension	Ağırlık Weight	Net Net	Güç Power	Kapasite Capacity
		a x b x c (mm)	(kg)	(m ³)	(kw)	(gn)
AND.ABSSD.10S	Soğuk Servis Ünitesi Cold Service Unit	1500x790x850	86	0.8	0.45	3x1/1 Gn
AND.ABSSD.50S	Soğuk Servis Ünitesi Cold Service Unit	2000x790x850	100	1	0.45	4x1/1 Gn
AND.ABSSD.90S	Soğuk Servis Ünitesi Cold Service Unit	2550x790x850	120	1.68	0.60	5x1/1 Gn

TEKNİK ÖZELLİKLER

- Kasa bölümlü üst tabla.
- Çalışma aralığı 0/+5 °C (tropikal 43 °C)
- 220-230V -1 +N 50-60 Hz elektrik gücü.
- "CFC Free" R-134 A soğutucu gaz.
- 40 kg/m³ yoğunluk.
- Sıcaklık ve defrost kontrollü dijital gösterge.
- Defrost esnasında otomatik su buharlaştırma.
- Fanlı soğutma.
- 48 mm kalınlığında "ozon dostu" poliüretan izolasyon.
- 45 derecede sabit kendiliğinden kapanan kapılar.
- Alüminyum panelli, bakır borulu evaporatör.
- Ayarlanabilir, paslanmaz çelik raf yuvaları, plastik raflar..
- Paslanmaz çelik gövde.
- Opsiyonel ön ahşap giydirme.
- Led aydınlatma.
- Paslanmaz çelik gövde.

TECHNICAL SPECIFICATIONS

- Top table has cashier section.
- Working temperature; 0/+5 °C at tropical ambient temperature 43 °C
- 220-230V -1 +N 50-60 Hz electrical power.
- "CFC Free" R-134 A refrigerant gas.
- 40 kg/m³ density.
- Temperature and defrost controlled digital display.
- Automatic evaporation of water during defrosting.
- Cooling with fan.
- Ozone-friendly" 48 mm thickness polyurethane isolation.
- Self-closing doors at 45 degrees.
- Copper tube evaporator with aluminum fins.
- Adjustable, stainless steel shelf housing, plastic coated shelves.
- Stainless steel body.
- Optional wooden front surface.
- Led lightning.
- Stainless steel body.

- R-290 Soğutucu Gaz Tipi için %3 fiyat farkı ekleyiniz. / Please add %3 price difference for R-290 refrigerant gas.
- Standart üretimimizde küvet bulunmamaktadır. / Standart product does not have containers.

* Lütfen, Siparişlerinizde ürün renk kodunu belirtiniz. / Please, Specify colour code on order.

Kod Code	Ürün Adı Description
-------------	-------------------------

AND.ABSSD.10S.AD.A Açık Eskieme Ahşap Dekor / Light Brown Wooden Decorated

AND.ABSSD.50S.AD.A Açık Eskieme Ahşap Dekor / Light Brown Wooden Decorated

AND.ABSSD.90S.AD.A Açık Eskieme Ahşap Dekor / Light Brown Wooden Decorated

Açık Eskieme
Light Brown

Kod Code	Ürün Adı Description
-------------	-------------------------

AND.ABSSD.10S.AD.K Koyu Eskieme Ahşap Dekor / Dark Brown Wooden Decorated

AND.ABSSD.50S.AD.K Koyu Eskieme Ahşap Dekor / Dark Brown Wooden Decorated

AND.ABSSD.90S.AD.K Koyu Eskieme Ahşap Dekor / Dark Brown Wooden Decorated

Koyu Eskieme
Dark Brown

Kod Code	Ürün Adı Description
-------------	-------------------------

AND.ABSSD.10S.AD.M Mahon Ahşap Dekor / Rusty Wooden Decorated

AND.ABSSD.50S.AD.M Mahon Ahşap Dekor / Rusty Wooden Decorated

AND.ABSSD.90S.AD.M Mahon Ahşap Dekor / Rusty Wooden Decorated

Mahon
Rusty

Kod Code	Ürün Adı Description
-------------	-------------------------

AND.ABSSD.10S.GT Granit Tabla (Standart Granit-Star Galaxy) / Standard Granite-Star Galaxy

AND.ABSSD.50S.GT Granit Tabla (Standart Granit-Star Galaxy) / Standard Granite-Star Galaxy

AND.ABSSD.90S.GT Granit Tabla (Standart Granit-Star Galaxy) / Standard Granite-Star Galaxy

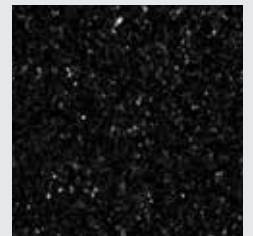
Star Galaxy Granit
Star Galaxy Granite

Kod Code	Ürün Adı Description
-------------	-------------------------

AND.ABSSD.10S.TK Tepsi Kaydırma Standı / Tray Sliding Stand

AND.ABSSD.50S.TK Tepsi Kaydırma Standı / Tray Sliding Stand

AND.ABSSD.90S.TK Tepsi Kaydırma Standı / Tray Sliding Stand

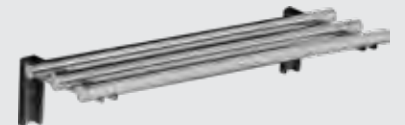



Kod Code	Ürün Adı Description	Ebatlar Dimension
		a x b x c (mm)
AND.ABSSD.10S.USC.T	Üst Raf Grup Tam Cam Farkı Top Shelf Group Full Glass Difference	1140x375x440
AND.ABSSD.50S.USC.T	Üst Raf Grup Tam Cam Farkı Top Shelf Group Full Glass Difference	1500x375x440
AND.ABSSD.90S.USC.T	Üst Raf Grup Tam Cam Farkı Top Shelf Group Full Glass Difference	2000x375x440



Kod Code	Ürün Adı Description	Ebatlar Dimension
		a x b x c (mm)
AND.ABSSD.10S.USC.Y	Üst Raf Grup Yarım Cam Farkı Top Shelf Group Half Glass Difference	1140x375x440
AND.ABSSD.50S.USC.Y	Üst Raf Grup Yarım Cam Farkı Top Shelf Group Half Glass Difference	1500x375x440
AND.ABSSD.90S.USC.Y	Üst Raf Grup Yarım Cam Farkı Top Shelf Group Half Glass Difference	2000x375x440



Kod Code	Ürün Adı Description	Ebatlar Dimension
		a x b x c (mm)
AND.ABSSD.10S.BC.T	Üst Grup Bombe Tam Cam Farkı Top Group Convex Full Glass Difference	1140x640x440
AND.ABSSD.50S.BC.T	Üst Grup Bombe Tam Cam Farkı Top Group Convex Full Glass Difference	1500x640x440
AND.ABSSD.90S.BC.T	Üst Grup Bombe Tam Cam Farkı Top Group Convex Full Glass Difference	2000x640x440



Kod Code	Ürün Adı Description	Ebatlar Dimension
		a x b x c (mm)
AND.ABSSD.10S.BC.Y	Üst Grup Bombe Yarım Cam Farkı Top Group Convex Half Glass Difference	1140x640x440
AND.ABSSD.50S.BC.Y	Üst Grup Bombe Yarım Cam Farkı Top Group Convex Half Glass Difference	1500x640x440
AND.ABSSD.90S.BC.Y	Üst Grup Bombe Yarım Cam Farkı Top Group Convex Half Glass Difference	2000x640x440



Kod Code	Ürün Adı Description	Ebatlar Dimension a x b x c (mm)	Ağırlık Weight (kg)	Net Net (m ³)	Kapasite Capacity (ızgara / grill cm)
AND.AOCK.010	Ocakbaşı (Davlumbazlı) Display Type Grill (with Hood)	960x790x2100	152	1.95	80
AND.AOCK.020	Ocakbaşı (Davlumbazlı) Display Type Grill (with Hood)	1360x790x2100	234	2.75	120
AND.AOCK.030	Ocakbaşı (Davlumbazlı) Display Type Grill (with Hood)	1760x790x2100	276	3.55	160

TEKNİK ÖZELLİKLER

- Ateş tuğlalı kömür ızgarası.
- Temperli cam.
- Filtreli davlumbaz.
- İç aydınlatma.
- Çekmeceli kömür deposu.
- Paslanmaz çelik gövde.

TECHNICAL SPECIFICATIONS

- Coal grill firebrick.
- Tempered glass.
- Hood with filter.
- Inside lighting.
- Coal drawer.
- Stainless steel body.

- Kömürlü Izgara Yerine Lavataşlı veya Sulu Izgara Koyabilme Opsiyonu. / Instead Of Coal Grill, Vapor Grill Or Lavastone Grill Option.
- Kömürlü Izgara Fiyata Dahildir. / Charcoal grill is Included in the price.

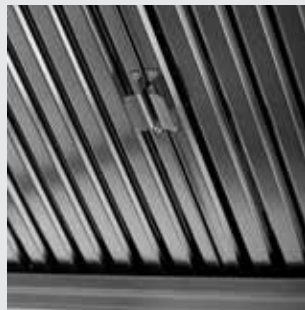

* Lütfen, Siparişlerinizde ürün renk kodunu belirtiniz. / Please, Specify colour code on order.

Kod Code	Ürün Adı Description
-------------	-------------------------

AND.AOCK.010.AD.A Açık Eskieme Ahşap Dekor / Light Brown Wooden Decorated

AND.AOCK.020.AD.A Açık Eskieme Ahşap Dekor / Light Brown Wooden Decorated

AND.AOCK.030.AD.A Açık Eskieme Ahşap Dekor / Light Brown Wooden Decorated

Açık Eskieme
Light Brown

Kod Code	Ürün Adı Description
-------------	-------------------------

AND.AOCK.010.AD.K Koyu Eskieme Ahşap Dekor / Dark Brown Wooden Decorated

AND.AOCK.020.AD.K Koyu Eskieme Ahşap Dekor / Dark Brown Wooden Decorated

AND.AOCK.030.AD.K Koyu Eskieme Ahşap Dekor / Dark Brown Wooden Decorated

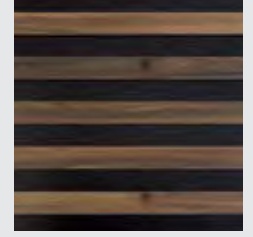
Koyu Eskieme
Dark Brown

Kod Code	Ürün Adı Description
-------------	-------------------------

AND.AOCK.010.AD.M Mahon Ahşap Dekor / Rusty Wooden Decorated

AND.AOCK.020.AD.M Mahon Ahşap Dekor / Rusty Wooden Decorated

AND.AOCK.030.AD.M Mahon Ahşap Dekor / Rusty Wooden Decorated

Mahon
Rusty

Kod Code	Ürün Adı Description
-------------	-------------------------

AND.AOCK.010.GT Granit Tabla (Standart Granit-Star Galaxy) / Standard Granite-Star Galaxy

AND.AOCK.020.GT Granit Tabla (Standart Granit-Star Galaxy) / Standard Granite-Star Galaxy

AND.AOCK.030.GT Granit Tabla (Standart Granit-Star Galaxy) / Standard Granite-Star Galaxy

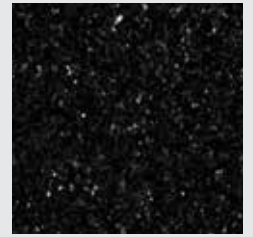
Star Galaxy Granit
Star Galaxy Granite

Kod Code	Ürün Adı Description
-------------	-------------------------

AND.AOCK.010.BR Bakır Davlumbaz / Copper Hood

AND.AOCK.020.BR Bakır Davlumbaz / Copper Hood

AND.AOCK.030.BR Bakır Davlumbaz / Copper Hood

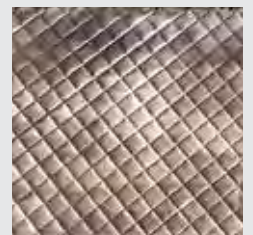
Bakır Davlumbaz
Copper Hood

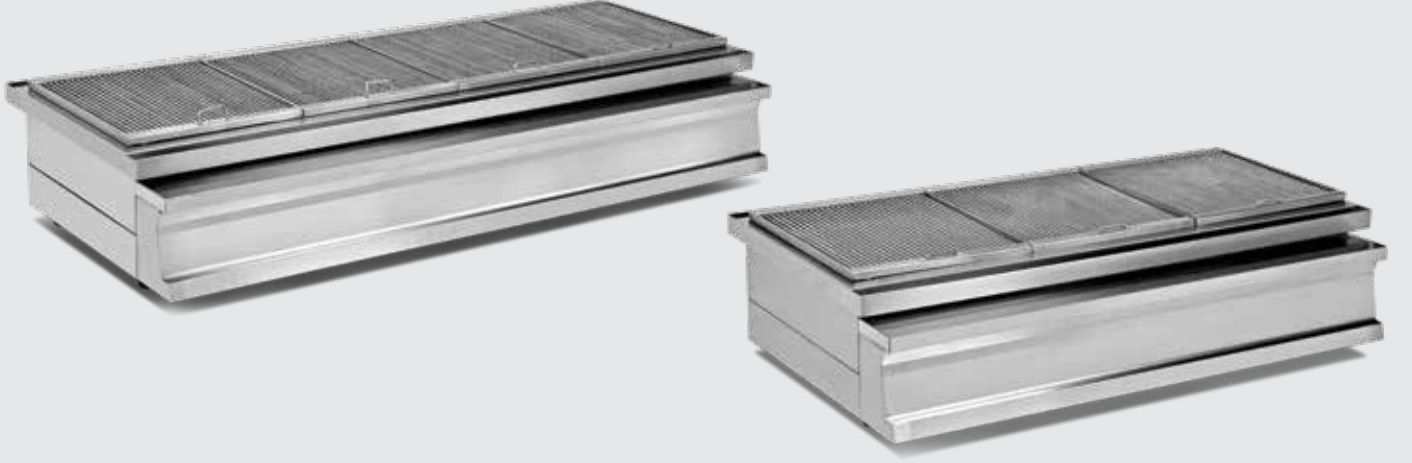

Kod Code	Ürün Adı Description	Ebatlar Dimension a x b x c (mm)	Ağırlık Weight (kg)	Net Net (m ³)
AND.AOCK.010-K	Kömürlü Izgara Charcoal Grill	800x730x290	70	0.16
AND.AOCK.020-K	Kömürlü Izgara Charcoal Grill	1200x730x290	90	0.25
AND.AOCK.030-K	Kömürlü Izgara Charcoal Grill	1600x730x290	105	0.33

TEKNİK ÖZELLİKLER

- Ateş tuğlalı kömür ızgarası.
- Kül Haznesi.
- Paslanmaz çelik gövde.

TECHNICAL SPECIFICATIONS

- Coal grill firebrick.
- Ash drawer.
- Stainless steel body.

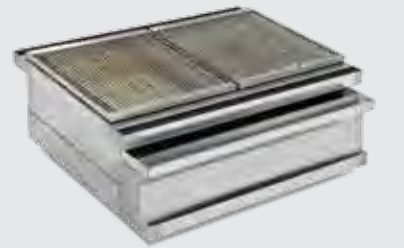



www.turkeyner.com



Kod Code	Ürün Adı Description	Ebatlar Dimension	Ağırlık Weight	Net Net
		a x b x c (mm)	(kg)	(m ³)
AND.ANS.10	Nötr Servis Ünitesi Neutral Service Unit	600x790x850	66	0.4
AND.ANS.30	Nötr Servis Ünitesi Neutral Service Unit	900x790x850	70	0.6
AND.ANS.50	Nötr Servis Ünitesi Neutral Service Unit	1150x790x850	85	0.8
AND.ANS.70	Nötr Servis Ünitesi Neutral Service Unit	1500x790x850	95	1
AND.ANS.90	Nötr Servis Ünitesi Neutral Service Unit	1800x790x850	105	1.2

TEKNİK ÖZELLİKLER

- Ayarlanabilir ayaklar.
- Opsiyonel ön ahşap giydirme.
- Paslanmaz çelik gövde.

TECHNICAL SPECIFICATIONS

- Adjustable feet.
- Optional wooden front surface.
- Stainless steel body.



* Lütfen, Siparişlerinizde ürün renk kodunu belirtiniz. / Please, Specify colour code on order.

Kod Code	Ürün Adı Description
-------------	-------------------------

AND.ANS.10.AD.A Açık Eskieme Ahşap Dekor / Light Brown Wooden Decorated

AND.ANS.30.AD.A Açık Eskieme Ahşap Dekor / Light Brown Wooden Decorated

AND.ANS.50.AD.A Açık Eskieme Ahşap Dekor / Light Brown Wooden Decorated

AND.ANS.70.AD.A Açık Eskieme Ahşap Dekor / Light Brown Wooden Decorated

AND.ANS.90.AD.A Açık Eskieme Ahşap Dekor / Light Brown Wooden Decorated

Kod Code	Ürün Adı Description
-------------	-------------------------

AND.ANS.10.AD.K Koyu Eskieme Ahşap Dekor / Dark Brown Wooden Decorated

AND.ANS.30.AD.K Koyu Eskieme Ahşap Dekor / Dark Brown Wooden Decorated

AND.ANS.50.AD.K Koyu Eskieme Ahşap Dekor / Dark Brown Wooden Decorated

AND.ANS.70.AD.K Koyu Eskieme Ahşap Dekor / Dark Brown Wooden Decorated

AND.ANS.90.AD.K Koyu Eskieme Ahşap Dekor / Dark Brown Wooden Decorated

Kod Code	Ürün Adı Description
-------------	-------------------------

AND.ANS.10.AD.M Mahon Ahşap Dekor / Rusty Wooden Decorated

AND.ANS.30.AD.M Mahon Ahşap Dekor / Rusty Wooden Decorated

AND.ANS.50.AD.M Mahon Ahşap Dekor / Rusty Wooden Decorated

AND.ANS.70.AD.M Mahon Ahşap Dekor / Rusty Wooden Decorated

AND.ANS.90.AD.M Mahon Ahşap Dekor / Rusty Wooden Decorated

Kod Code	Ürün Adı Description
-------------	-------------------------

AND.ANS.10.GT Granit Tabla (Standart Granit-Star Galaxy) / Standard Granite-Star Galaxy

AND.ANS.30.GT Granit Tabla (Standart Granit-Star Galaxy) / Standard Granite-Star Galaxy

AND.ANS.50.GT Granit Tabla (Standart Granit-Star Galaxy) / Standard Granite-Star Galaxy

AND.ANS.70.GT Granit Tabla (Standart Granit-Star Galaxy) / Standard Granite-Star Galaxy

AND.ANS.90.GT Granit Tabla (Standart Granit-Star Galaxy) / Standard Granite-Star Galaxy

Kod Code	Ürün Adı Description
-------------	-------------------------

AND.ANS.10.TK Tepsi Kaydırma Standı / Tray Sliding Stand

AND.ANS.30.TK Tepsi Kaydırma Standı / Tray Sliding Stand

AND.ANS.50.TK Tepsi Kaydırma Standı / Tray Sliding Stand

AND.ANS.70.TK Tepsi Kaydırma Standı / Tray Sliding Stand

AND.ANS.90.TK Tepsi Kaydırma Standı / Tray Sliding Stand

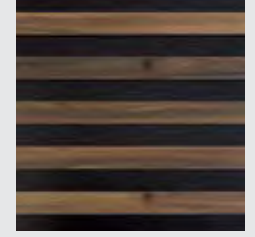
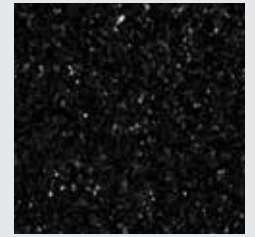
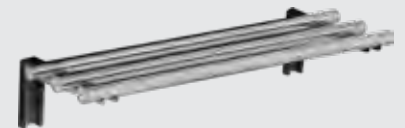
Açık Eskieme
Light BrownKoyu Eskieme
Dark BrownMahon
RustyStar Galaxy Granit
Star Galaxy Granite



Kod Code	Ürün Adı Description	Ebatlar Dimension
		a x b x c (mm)
AND.ANS.10.USC.T	Üst Raf Grup Tam Cam Farkı Top Shelf Group Full Glass Difference	600x375x440
AND.ANS.30.USC.T	Üst Raf Grup Tam Cam Farkı Top Shelf Group Full Glass Difference	900x375x440
AND.ANS.50.USC.T	Üst Raf Grup Tam Cam Farkı Top Shelf Group Full Glass Difference	1150x375x440
EAND.ANS.70.USC.T	Üst Raf Grup Tam Cam Farkı Top Shelf Group Full Glass Difference	1500x375x440
AND.ANS.90.USC.T	Üst Raf Grup Tam Cam Farkı Top Shelf Group Full Glass Difference	1800x375x440



Kod Code	Ürün Adı Description	Ebatlar Dimension
		a x b x c (mm)
AND.ANS.10.USC.Y	Üst Raf Grup Yarım Cam Farkı Top Shelf Group Half Glass Difference	600x375x440
AND.ANS.30.USC.Y	Üst Raf Grup Yarım Cam Farkı Top Shelf Group Half Glass Difference	900x375x440
AND.ANS.50.USC.Y	Üst Raf Grup Yarım Cam Farkı Top Shelf Group Half Glass Difference	1150x375x440
AND.ANS.70.USC.Y	Üst Raf Grup Yarım Cam Farkı Top Shelf Group Half Glass Difference	1500x375x440
AND.ANS.90.USC.Y	Üst Raf Grup Yarım Cam Farkı Top Shelf Group Half Glass Difference	1800x375x440



Kod Code	Ürün Adı Description	Ebatlar Dimension
		a x b x c (mm)
AND.ANS.10.BC.T	Üst Grup Bombe Tam Cam Farkı Top Group Convex Full Glass Difference	600x640x440
AND.ANS.30.BC.T	Üst Grup Bombe Tam Cam Farkı Top Group Convex Full Glass Difference	900x640x440
AND.ANS.50.BC.T	Üst Grup Bombe Tam Cam Farkı Top Group Convex Full Glass Difference	1150x640x440
AND.ANS.70.BC.T	Üst Grup Bombe Tam Cam Farkı Top Group Convex Full Glass Difference	1500x640x440
AND.ANS.90.BC.T	Üst Grup Bombe Tam Cam Farkı Top Group Convex Full Glass Difference	1800x640x440



Kod Code	Ürün Adı Description	Ebatlar Dimension
		a x b x c (mm)
AND.ANS.10.BC.Y	Üst Grup Bombe Yarım Cam Farkı Top Group Convex Half Glass Difference	600x640x440
AND.ANS.30.BC.Y	Üst Grup Bombe Yarım Cam Farkı Top Group Convex Half Glass Difference	900x640x440
AND.ANS.50.BC.Y	Üst Grup Bombe Yarım Cam Farkı Top Group Convex Half Glass Difference	1150x640x440
AND.ANS.70.BC.Y	Üst Grup Bombe Yarım Cam Farkı Top Group Convex Half Glass Difference	1500x640x440
AND.ANS.90.BC.Y	Üst Grup Bombe Yarım Cam Farkı Top Group Convex Half Glass Difference	1800x640x440



Kod Code	Ürün Adı Description	Ebatlar Dimension	Ağırlık Weight	Net Net
		a x b x c (mm)	(kg)	(m ³)
AND.ABKT.10	Köşe Servis Ünitesi Corner Service Unit	1400x790x850	75	0.9

TEKNİK ÖZELLİKLER

- Ayarlanabilir ayaklar.
- Opsiyonel ön ahşap giydirme.
- Paslanmaz çelik gövde.

TECHNICAL SPECIFICATIONS

- Adjustable feet.
- Optional wooden front surface.
- Stainless steel body.



Kod Code	Ürün Adı Description	Ebatlar Dimension	Ağırlık Weight	Net Net
		a x b x c (mm)	(kg)	(m ³)
AND.ABKU.10	Küver Ünitesi Cutlery Unit	800x790x850/1350	75	0.8

TEKNİK ÖZELLİKLER

- Ayarlanabilir ayaklar.
- Opsiyonel ön ahşap giydirme.
- Paslanmaz çelik gövde.

TECHNICAL SPECIFICATIONS

- Adjustable feet.
- Optional wooden front surface.
- Stainless steel body.

Standart üretimimizde küvet bulunmamaktadır. / Standart product does not have containers.

* Lütfen, Siparişlerinizde ürün renk kodunu belirtiniz. / Please, Specify colour code on order.

Kod Code	Ürün Adı Description
-------------	-------------------------

AND.ABKT.10.AD.A Açık Eskieme Ahşap Dekor / Light Brown Wooden Decorated

AND.ABKU.10.AD.A Açık Eskieme Ahşap Dekor / Light Brown Wooden Decorated



Açık Eskieme
Light Brown

Kod Code	Ürün Adı Description
-------------	-------------------------

AND.ABKT.10.AD.K Koyu Eskieme Ahşap Dekor / Dark Brown Wooden Decorated

AND.ABKU.10.AD.K Koyu Eskieme Ahşap Dekor / Dark Brown Wooden Decorated

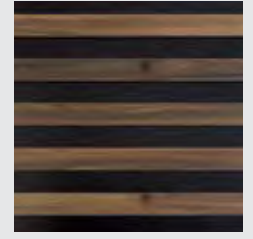

Koyu Eskieme
Dark Brown

Kod Code	Ürün Adı Description
-------------	-------------------------

AND.ABKT.10.AD.M Mahon Ahşap Dekor / Rusty Wooden Decorated

AND.ABKU.10.AD.M Mahon Ahşap Dekor / Rusty Wooden Decorated



Mahon
Rusty

Kod Code	Ürün Adı Description
-------------	-------------------------

AND.ABKT.10.GT Granit Tabla (Standart Granit-Star Galaxy) / Standard Granite-Star Galaxy

AND.ABKU.10.GT Granit Tabla (Standart Granit-Star Galaxy) / Standard Granite-Star Galaxy

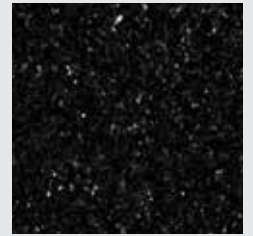

Star Galaxy Granit
Star Galaxy Granite

Kod Code	Ürün Adı Description
-------------	-------------------------

AND.ABKT.10.TK Tepsi Kaydırma Standı / Tray Sliding Stand

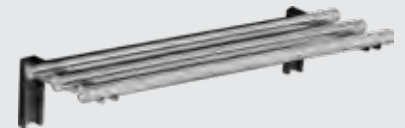

Teşhir Ürünleri Display Products

Merkür Et ve Meze Vitrinleri (Bombe Camlı) Mercury Meat and Appetizer Showcases (Convex Glass)

andora



**Buğulanma yapmayan ön ısı cam.
Condensation blocker double glazing.**

Kod Code	Ürün Adı Description	Ebatlar Dimension	Ağırlık Weight	Net Net	Soğ. Kap Cooling Cap
		a x b x c (mm)	(kg)	(m ³)	(kw)
AND.AMZ.100.A.BC	Merkür Et ve Meze Vitrini Ahşap Dekorlu Mercury Meat Appetizer Showcase Wooden Decorated	1000x750x1350	240	1.1	1.01
AND.AMZ.100.P.BC	Merkür Et ve Meze Vitrini Paslanmaz Çelik Mercury Meat Appetizer Showcase Stainless Steel	1000x750x1350	240	1.1	1.01
AND.AMZ.150.A.BC	Merkür Et ve Meze Vitrini Ahşap Dekorlu Mercury Meat Appetizer Showcase Wooden Decorated	1500x750x1350	296	1.4	1.08
AND.AMZ.150.P.BC	Merkür Et ve Meze Vitrini Paslanmaz Çelik Mercury Meat Appetizer Showcase Stainless Steel	1500x750x1350	296	1.4	1.08
AND.AMZ.200.A.BC	Merkür Et ve Meze Vitrini Ahşap Dekorlu Mercury Meat Appetizer Showcase Wooden Decorated	2000x750x1350	350	1.9	1.73
AND.AMZ.200.P.BC	Merkür Et ve Meze Vitrini Paslanmaz Çelik Mercury Meat Appetizer Showcase Stainless Steel	2000x750x1350	350	1.9	1.73

TEKNİK ÖZELLİKLER

- Çalışma aralığı; 0/+8 °C (tropikal 43 °C)
- İçten motorlu soğutma uygulaması.
- Reyon altı depolama sistemi.
- Bombe camlı meze vitrinlerinde, açılabilir ön cam.
- Fanlı soğutma.
- R-134 A soğutucu gaz.
- Led aydınlatma sistemi.
- 40 kg/m³ yoğunluk poliüretan izolasyon.

TECHNICAL SPECIFICATIONS

- Working temperature; 0/+8 °C (at ambient temp. 43 °C)
- Interior engaged refrigerating system.
- Under-set storage system.
- Lift up safety front glass, for convex glass showcase.
- Fan cooling.
- R-134 A refrigerant gas.
- Led lighting system.
- 40 kg/m³ density polyurathane isolation.

Renk Seçenekleri Color Options



**Açık Eskitme
Light Brown**

Renk Kodları Color Codes

AND.AMZ.100.A.BC-A
AND.AMZ.100.P.BC-A
AND.AMZ.150.A.BC-A
AND.AMZ.150.P.BC-A
AND.AMZ.200.A.BC-A
AND.AMZ.200.P.BC-A

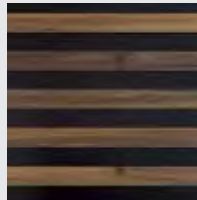

**Koyu Eskitme
Dark Brown**

Renk Kodları Color Codes

AND.AMZ.100.A.BC-K
AND.AMZ.100.P.BC-K
AND.AMZ.150.A.BC-K
AND.AMZ.150.P.BC-K
AND.AMZ.200.A.BC-K
AND.AMZ.200.P.BC-K

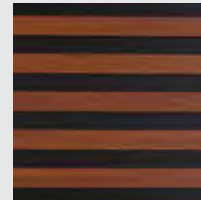

**Mahon
Rusty**

Renk Kodları Color Codes

AND.AMZ.100.A.BC-M
AND.AMZ.100.P.BC-M
AND.AMZ.150.A.BC-M
AND.AMZ.150.P.BC-M
AND.AMZ.200.A.BC-M
AND.AMZ.200.P.BC-M

*** Lütfen, Siparişlerinizde ürün rengini belirtiniz. / Please, Specify colour on order.**



Buğulanma yapmayan ön ısı cam.
Condensation blocker double glazing.

Kod Code	Ürün Adı Description	Ebatlar Dimension	Ağırlık Weight	Net Net	Soğ. Kap Cooling Cap
		a x b x c (mm)	(kg)	(m ³)	(kw)
AND.AMZ.100.A.DC	Merkür Et ve Meze Vitrini Ahşap Dekorlu Mercury Meat Appetizer Showcase Wooden Decorated	1000x750x1350	240	1.1	1.01
AND.AMZ.100.P.DC	Merkür Et ve Meze Vitrini Paslanmaz Çelik Mercury Meat Appetizer Showcase Stainless Steel	1000x750x1350	240	1.1	1.01
AND.AMZ.150.A.DC	Merkür Et ve Meze Vitrini Ahşap Dekorlu Mercury Meat Appetizer Showcase Wooden Decorated	1500x750x1350	296	1.4	1.08
AND.AMZ.150.P.DC	Merkür Et ve Meze Vitrini Paslanmaz Çelik Mercury Meat Appetizer Showcase Stainless Steel	1500x750x1350	296	1.4	1.08
AND.AMZ.200.A.DC	Merkür Et ve Meze Vitrini Ahşap Dekorlu Mercury Meat Appetizer Showcase Wooden Decorated	2000x750x1350	350	1.9	1.73
AND.AMZ.200.P.DC	Merkür Et ve Meze Vitrini Paslanmaz Çelik Mercury Meat Appetizer Showcase Stainless Steel	2000x750x1350	350	1.9	1.73

TEKNİK ÖZELLİKLER

- Çalışma aralığı; 0/+8 °C (tropikal 43 °C)
- İçten motorlu soğutma uygulaması.
- Reyon altı depolama sistemi.
- Fanlı soğutma.
- R-134 A soğutucu gaz.
- Led aydınlatma sistemi.
- 40 kg/m³ yoğunluk poliüretan izolasyon.

TECHNICAL SPECIFICATIONS

- Working temperature; 0/+8 °C (at ambient temp. 43 °C)
- Interior engined refrigerating system.
- Under-set storage system.
- Fan cooling.
- R-134 A refrigerant gas.
- Led lighting system.
- 40 kg/m³ density polyurathane isolation.

Renk Seçenekleri Color Options



Açık Eskitme
Light Brown

Renk Kodları Color Codes

AND.AMZ.100.A.DC-A
AND.AMZ.100.P.DC-A
AND.AMZ.150.A.DC-A
AND.AMZ.150.P.DC-A
AND.AMZ.200.A.DC-A
AND.AMZ.200.P.DC-A

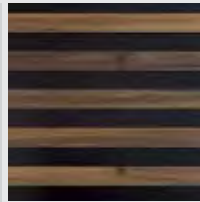

Koyu Eskitme
Dark Brown

Renk Kodları Color Codes

AND.AMZ.100.A.DC-K
AND.AMZ.100.P.DC-K
AND.AMZ.150.A.DC-K
AND.AMZ.150.P.DC-K
AND.AMZ.200.A.DC-K
AND.AMZ.200.P.DC-K

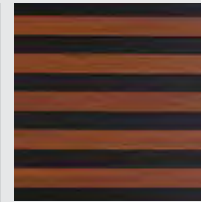

Mahon
Rusty

Renk Kodları Color Codes

AND.AMZ.100.A.DC-M
AND.AMZ.100.P.DC-M
AND.AMZ.150.A.DC-M
AND.AMZ.150.P.DC-M
AND.AMZ.200.A.DC-M
AND.AMZ.200.P.DC-M

* Lütfen, Siparişlerinizde ürün rengini belirtiniz. / Please, Specify colour on order.

Teşhir Ürünleri Display Products

Plüton Et ve Meze Teşhir Vitrinleri (Düz Camlı) Pluton Meat and Apettizer Showcase (Flat Glass)

andora

CE



**Buğulanma yapmayan ön ısı cam.
Condensation blocker double glazing.**

Kod Code	Ürün Adı Description	Ebatlar Dimension	Ağırlık Weight	Net Net	Soğ. Kap Cooling Cap
		a x b x c (mm)	(kg)	(m ³)	(kw)
AND.AVT.D.100.S	Plüton Et ve Meze Teşhir Vitrini Pluton Meat and Apettizer Showcase	1000x870x1350	191	1.1	1.73
AND.AVT.D.130.S	Plüton Et ve Meze Teşhir Vitrini Pluton Meat and Apettizer Showcase	1300x870x1350	257	1.2	1.73
AND.AVT.D.160.S	Plüton Et ve Meze Teşhir Vitrini Pluton Meat and Apettizer Showcase	1600x870x1350	265	1.5	1.73
AND.AVT.D.200.S	Plüton Et ve Meze Teşhir Vitrini Pluton Meat and Apettizer Showcase	2000x870x1350	319	1.5	2.07

TEKNİK ÖZELLİKLER

- Çalışma aralığı 0/+8 °C (tropikal 43 °C)
- İçten motorlu soğutma uygulaması.
- Reyon altı depolama sistemi.
- Fanlı soğutma.
- R-134 A soğutucu gaz.
- Led aydınlatma sistemi.
- 40 kg/m³ yoğunluk poliüretan izolasyon.

TECHNICAL SPECIFICATIONS

- Working temperature 0/+8 °C (at ambient temp. 43 °C)
- Interior engined refrigeration system.
- Under-set storage system.
- Cooling with fan.
- Refrigerant gas: R-134 A
- Led lighting system.
- 40 kg/m³ density polyurathane isolation.

Renk Seçenekleri Color Options



Açık Eskitme
Light Brown

Renk Kodları Color Codes

AND.AVT.D.100.S.A
AND.AVT.D.130.S.A
AND.AVT.D.160.S.A
AND.AVT.D.200.S.A

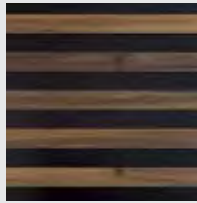

Koyu Eskitme
Dark Brown

Renk Kodları Color Codes

AND.AVT.D.100.S.K
AND.AVT.D.130.S.K
AND.AVT.D.160.S.K
AND.AVT.D.200.S.K

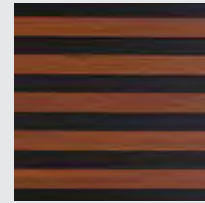

Mahon
Rusty

Renk Kodları Color Codes

AND.AVT.D.100.S.M
AND.AVT.D.130.S.M
AND.AVT.D.160.S.M
AND.AVT.D.200.S.M

*** Lütfen, Siparişlerinizde ürün renk kodunu belirtiniz. / Please, Specify colour code on order.**



Buğulanma yapmayan ön ısı cam.
Condensation blocker double glazing.

Kod Code	Ürün Adı Description	Ebatlar Dimension	Ağırlık Weight	Net Net	Soğ. Kap Cooling Cap
		a x b x c (mm)	(kg)	(m ³)	(kw)
AND.AVT.B.100.S	Plüton Et ve Meze Teşhir Vitrini Pluton Meat and Apettizer Showcase	1000x870x1350	191	1.1	1.73
AND.AVT.B.130.S	Plüton Et ve Meze Teşhir Vitrini Pluton Meat and Apettizer Showcase	1300x870x1350	257	1.2	1.73
AND.AVT.B.160.S	Plüton Et ve Meze Teşhir Vitrini Pluton Meat and Apettizer Showcase	1600x870x1350	265	1.5	1.73
AND.AVT.B.200.S	Plüton Et ve Meze Teşhir Vitrini Pluton Meat and Apettizer Showcase	2000x870x1350	319	1.5	2.07

TEKNİK ÖZELLİKLER

- Çalışma aralığı 0/+8 °C (tropikal 43 °C)
- İçten motorlu soğutma uygulaması.
- Reyon altı depolama sistemi.
- Açılabilir ön cam.
- Fanlı soğutma.
- R-134 A soğutucu gaz.
- Led aydınlatma sistemi.
- 40 kg/m³ yoğunluk poliüretan izolasyon.

TECHNICAL SPECIFICATIONS

- Working temperature 0/+8 °C (at ambient temp. 43 °C)
- Interior engined refrigeration system.
- Under-set storage system.
- Lift up safety front glass.
- Cooling with fan.
- Refrigerant gas:R-134 A
- Led lighting system.
- 40 kg/m³ density polyurathane isolation.

Renk Seçenekleri Color Options



Açık EskiTme
Light Brown

Renk Kodları Color Codes

AND.AVT.B.100.S.A
AND.AVT.B.130.S.A
AND.AVT.B.160.S.A
AND.AVT.B.200.S.A

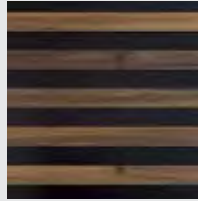

Koyu EskiTme
Dark Brown

Renk Kodları Color Codes

AND.AVT.B.100.S.K
AND.AVT.B.130.S.K
AND.AVT.B.160.S.K
AND.AVT.B.200.S.K

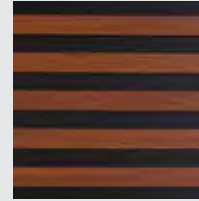

Mahon
Rusty

Renk Kodları Color Codes

AND.AVT.B.100.S.M
AND.AVT.B.130.S.M
AND.AVT.B.160.S.M
AND.AVT.B.200.S.M

* Lütfen, Siparişlerinizde ürün renk kodunu belirtiniz. / Please, Specify colour code on order.

Teşhir Ürünleri Display Products

Neptün Pasta Vitrinleri (Soğutmalı) Neptun Pastry Showcase (with Cooling)

andora

CE



**Buğulanma yapmayan ön ısı cam.
Condensation blocker double glazing.**

Kod Code	Ürün Adı Description	Ebatlar Dimension	Ağırlık Weight	Net Net	Soğ. Kap Cooling Cap
		a x b x c (mm)	(kg)	(m ³)	(kw)
AND.ADT.100.S	Neptün Pasta Vitrini Soğutmalı Neptün Pastry Showcase with Cooling	1000x750x1350	172	1.01	1.15
AND.ADT.130.S	Neptün Pasta Vitrini Soğutmalı Neptün Pastry Showcase with Cooling	1300x750x1350	224	1.2	1.73
AND.ADT.160.S	Neptün Pasta Vitrini Soğutmalı Neptün Pastry Showcase with Cooling	1600x750x1350	276	1.5	1.73
AND.ADT.200.S	Neptün Pasta Vitrini Soğutmalı Neptün Pastry Showcase with Cooling	2000x750x1350	330	1.9	2.07

TEKNİK ÖZELLİKLER

- Çalışma aralığı; 0/+8 °C (tropikal 43 °C)
- İçten motorlu soğutma uygulaması.
- Fanlı soğutma.
- R-134 A soğutucu gaz.
- Led aydınlatma sistemi.
- 40 kg/m³ yoğunluk poliüretan izolasyon.

TECHNICAL SPECIFICATIONS

- Working temperature; 0/+8 °C (at ambient temperature 43 °C)
- Interior engine refrigeration system.
- Cooling with fan.
- Refrigerant gas: R-134 A
- Led lighting system.
- 40 kg/m³ density polyurethane isolation.

Renk Seçenekleri Color Options



Açık Eskitme
Light Brown

Renk Kodları
Color Codes
AND.ADT.100.S-A
AND.ADT.130.S-A
AND.ADT.160.S-A
AND.ADT.200.S-A

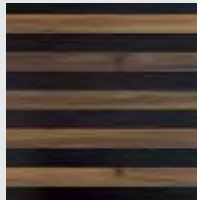

Koyu Eskitme
Dark Brown

Renk Kodları
Color Codes
AND.ADT.100.S-K
AND.ADT.130.S-K
AND.ADT.160.S-K
AND.ADT.200.S-K

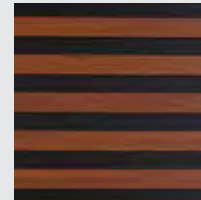

Mahon
Rusty

Renk Kodları
Color Codes
AND.ADT.100.S-M
AND.ADT.130.S-M
AND.ADT.160.S-M
AND.ADT.200.S-M

*** Lütfen, Siparişlerinizde ürün renk kodunu belirtiniz. / Please, Specify colour code on order.**



Kod Code	Ürün Adı Description	Ebatlar Dimension	Ağırlık Weight	Net Net
		a x b x c (mm)	(kg)	(m ³)
AND.ADT.100.N	Neptün Pasta Vitrini Nötr Neptün Pastry Showcase Neutral	1000x750x1350	158	1.01
AND.ADT.130.N	Neptün Pasta Vitrini Nötr Neptün Pastry Showcase Neutral	1300x750x1350	204	1.2
AND.ADT.160.N	Neptün Pasta Vitrini Nötr Neptün Pastry Showcase Neutral	1600x750x1350	250	1.5
AND.ADT.200.N	Neptün Pasta Vitrini Nötr Neptün Pastry Showcase Neutral	2000x750x1350	300	1.9

TEKNİK ÖZELLİKLER

- Led aydınlatma sistemi.

TECHNICAL SPECIFICATIONS

- Led lighting system.

Renk Seçenekleri Color Options



Açık Eskieme
Light Brown

Renk Kodları
Color Codes
AND.ADT.100.N-A
AND.ADT.130.N-A
AND.ADT.160.N-A
AND.ADT.200.N-A

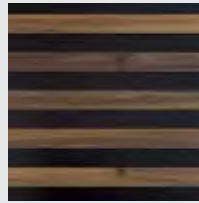

Koyu Eskieme
Dark Brown

Renk Kodları
Color Codes
AND.ADT.100.N-K
AND.ADT.130.N-K
AND.ADT.160.N-K
AND.ADT.200.N-K

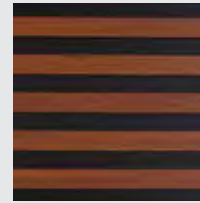

Mahon
Rusty

Renk Kodları
Color Codes
AND.ADT.100.N-M
AND.ADT.130.N-M
AND.ADT.160.N-M
AND.ADT.200.N-M

* Lütfen, Siparişlerinizde ürün renk kodunu belirtiniz. / Please, Specify colour code on order.



Buğulanma yapmayan ön ısı cam.
Condensation blocker double glazing.

Kod Code	Ürün Adı Description	Ebatlar Dimension	Ağırlık Weight	Net Net
		a x b x c (mm)	(kg)	(m ³)
AND.ADT.100.I	Neptün Pasta Vitrini Isıtmalı Neptün Pastry Showcase with Heating	1000x750x1350	165	1.01
AND.ADT.130.I	Neptün Pasta Vitrini Isıtmalı Neptün Pastry Showcase with Heating	1300x750x1350	210	1.2
AND.ADT.160.I	Neptün Pasta Vitrini Isıtmalı Neptün Pastry Showcase with Heating	1600x750x1350	255	1.5
AND.ADT.200.I	Neptün Pasta Vitrini Isıtmalı Neptün Pastry Showcase with Heating	2000x750x1350	305	1.9

TEKNİK ÖZELLİKLER

- Çalışma aralığı; 0/+60 °
- Led aydınlatma sistemi.

TECHNICAL SPECIFICATIONS

- Working temperature; 0/+60 °C
- Led lighting system.

Renk Seçenekleri Color Options



Açık Eskitme
Light Brown

Renk Kodları Color Codes

AND.ADT.100.I-A
AND.ADT.130.I-A
AND.ADT.160.I-A
AND.ADT.200.I-A

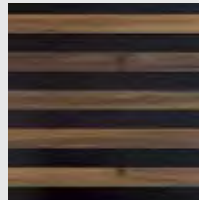

Koyu Eskitme
Dark Brown

Renk Kodları Color Codes

AND.ADT.100.I-K
AND.ADT.130.I-K
AND.ADT.160.I-K
AND.ADT.200.I-K

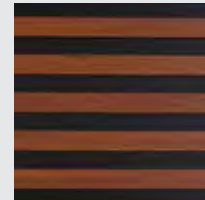

Mahon
Rusty

Renk Kodları Color Codes

AND.ADT.100.I-M
AND.ADT.130.I-M
AND.ADT.160.I-M
AND.ADT.200.I-M

* Lütfen, Siparişlerinizde ürün renk kodunu belirtiniz. / Please, Specify colour code on order.



Buğulanma yapmayan ön ısı cam.
Condensation blocker double glazing.

Kod Code	Ürün Adı Description	Ebatlar Dimension	Ağırlık Weight	Net Net	Soğ. Kap Cooling Cap
		a x b x c (mm)	(kg)	(m ³)	(kw)
AND.ABC.100.S	Venüs Pasta Vitrini Soğutmalı Venus Pastry Showcase with Cooling	1000x750x1350	172	1.01	1.15
AND.ABC.130.S	Venüs Pasta Vitrini Soğutmalı Venus Pastry Showcase with Cooling	1300x750x1350	224	1.2	1.73
AND.ABC.160.S	Venüs Pasta Vitrini Soğutmalı Venus Pastry Showcase with Cooling	1600x750x1350	276	1.5	1.73
AND.ABC.200.S	Venüs Pasta Vitrini Soğutmalı Venus Pastry Showcase with Cooling	2000x750x1350	330	1.9	2.07

TEKNİK ÖZELLİKLER

- Çalışma aralığı; 0/+8 °C (tropikal 43 °C)
- İçten motorlu soğutma uygulaması.
- Açılabilir ön cam.
- Fanlı soğutma.
- R-134 A soğutucu gaz.
- Led aydınlatma sistemi.
- 40 kg/m³ yoğunluk poliüretan izolasyon.

TECHNICAL SPECIFICATIONS

- Working temperature; 0/+8 °C (at ambient temperature 43 °C)
- Interior engined refrigeration system
- Lift up safety front glass.
- Cooling with fan.
- Refrigerant gas: R-134 A
- Led lighting system.
- 40 kg/m³ density polyurathane isolation.

Renk Seçenekleri
 Color Options

Açık EskiTme
Light Brown

Renk Kodları
 Color Codes

AND.ABC.100.S-A
 AND.ABC.130.S-A
 AND.ABC.160.S-A
 AND.ABC.200.S-A

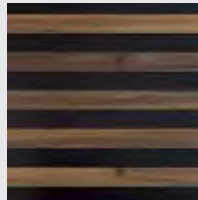

Koyu EskiTme
Dark Brown

Renk Kodları
 Color Codes

AND.ABC.100.S-K
 AND.ABC.130.S-K
 AND.ABC.160.S-K
 AND.ABC.200.S-K

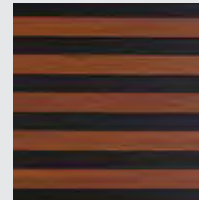

Mahon
Rusty

Renk Kodları
 Color Codes

AND.ABC.100.S-M
 AND.ABC.130.S-M
 AND.ABC.160.S-M
 AND.ABC.200.S-M

* Lütfen, Siparişlerinizde ürün renk kodunu belirtiniz. / Please, Specify colour code on order.



Kod Code	Ürün Adı Description	Ebatlar Dimension	Ağırlık Weight	Net Net
		a x b x c (mm)	(kg)	(m³)
AND.ABC.100.N	Venüs Pasta Vitrini Nötr Venus Pastry Showcase Neutral	1000x750x1350	158	1.01
AND.ABC.130.N	Venüs Pasta Vitrini Nötr Venus Pastry Showcase Neutral	1300x750x1350	204	1.2
AND.ABC.160.N	Venüs Pasta Vitrini Nötr Venus Pastry Showcase Neutral	1600x750x1350	250	1.5
AND.ABC.200.N	Venüs Pasta Vitrini Nötr Venus Pastry Showcase Neutral	2000x750x1350	300	1.9

TEKNİK ÖZELLİKLER

- Reyon altı depolama sistemi.
- Açılabilir ön cam.
- Led aydınlatma sistemi.

TECHNICAL SPECIFICATIONS

- Under-set storage system.
- Lift up safety front glass.
- Led lighting system.

Renk Seçenekleri Color Options



Açık Eskitme
Light Brown

Renk Kodları
Color Codes
AND.ABC.100.N-A
AND.ABC.130.N-A
AND.ABC.160.N-A
AND.ABC.200.N-A

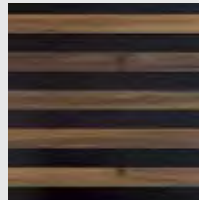

Koyu Eskitme
Dark Brown

Renk Kodları
Color Codes
AND.ABC.100.N-K
AND.ABC.130.N-K
AND.ABC.160.N-K
AND.ABC.200.N-K

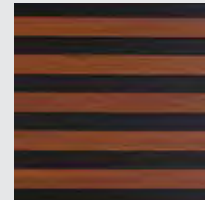

Mahon
Rusty

Renk Kodları
Color Codes
AND.ABC.100.N-M
AND.ABC.130.N-M
AND.ABC.160.N-M
AND.ABC.200.N-M

* Lütfen, Siparişlerinizde ürün renk kodunu belirtiniz. / Please, Specify colour code on order.



Buğulanma yapmayan ön ısı cam.
Condensation blocker double glazing.

Kod Code	Ürün Adı Description	Ebatlar Dimension	Ağırlık Weight	Net Net
		a x b x c (mm)	(kg)	(m ³)
AND.ABC.100.I	Venüs Pasta Vitrini Isıtmalı Venus Pastry Showcase with Heating	1000x750x1350	165	1.01
AND.ABC.130.I	Venüs Pasta Vitrini Isıtmalı Venus Pastry Showcase with Heating	1300x750x1350	350	1.2
AND.ABC.160.I	Venüs Pasta Vitrini Isıtmalı Venus Pastry Showcase with Heating	1600x750x1350	255	1.5
AND.ABC.200.I	Venüs Pasta Vitrini Isıtmalı Venus Pastry Showcase with Heating	2000x750x1350	305	1.9

TEKNİK ÖZELLİKLER

- Çalışma aralığı; 0/+60 °
- Reyon altı depolama sistemi.
- Led aydınlatma sistemi.

TECHNICAL SPECIFICATIONS

- Working temperature; 0/+60 °C
- Bottom storage cabinet.
- Led lighting system.

Renk Seçenekleri Color Options



Açık EskiTme
Light Brown

Renk Kodları Color Codes

AND.ABC.100.I-A
AND.ABC.130.I-A
AND.ABC.160.I-A
AND.ABC.200.I-A

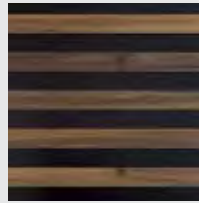

Koyu EskiTme
Dark Brown

Renk Kodları Color Codes

AND.ABC.100.I-K
AND.ABC.130.I-K
AND.ABC.160.I-K
AND.ABC.200.I-K

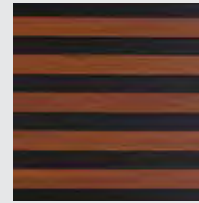

Mahon
Rusty

Renk Kodları Color Codes

AND.ABC.100.I-M
AND.ABC.130.I-M
AND.ABC.160.I-M
AND.ABC.200.I-M

* Lütfen, Siparişlerinizde ürün renk kodunu belirtiniz. / Please, Specify colour code on order.



Açık Büfe Sistemleri

Buffet Systems



andora

andora

AÇIK BÜFE SİSTEMLERİ

Galata Model

- Galata Nötr Servis Üniteleri
- Galata Nötr Servis Üniteleri (Nefeslikli)
- Galata Soğuk Servis Üniteleri (Nefeslikli)
- Galata Paslanmaz Soğuk Servis Üniteleri (Nefeslikli)
- Galata Sıcak Servis Üniteleri (Nefeslikli)
- Galata Sıcak Servis Üniteleri (Reşolu)
- Galata Çorba Servis Ünitesi
- Galata Ekmek Servis Üniteleri
- Galata U Form Tabaklık
- Galata Tabak Dispenseri

Kapadokya Model

- Kapadokya Nötr Servis Üniteleri
- Kapadokya Nötr Servis Üniteleri (Nefeslikli)
- Kapadokya Soğuk Servis Üniteleri (Nefeslikli)
- Kapadokya Paslanmaz Soğuk Servis Üniteleri (Nefeslikli)
- Kapadokya Sıcak Servis Üniteleri (Nefeslikli)
- Kapadokya Sıcak Servis Üniteleri (Reşolu)
- Kapadokya Çorba Servis Ünitesi
- Kapadokya Ekmek Servis Üniteleri
- Kapadokya U Form Tabaklık
- Kapadokya Tabak Dispenseri

Sümela Model

- Sümela Nötr Servis Üniteleri
- Sümela Nötr Servis Üniteleri (Nefeslikli)
- Sümela Soğuk Servis Üniteleri (Nefeslikli)
- Sümela Paslanmaz Soğuk Servis Üniteleri (Nefeslikli)
- Sümela Sıcak Servis Üniteleri (Nefeslikli)
- Sümela Sıcak Servis Üniteleri (Reşolu)
- Sümela Çorba Servis Ünitesi
- Sümela Ekmek Servis Üniteleri
- Sümela U Form Tabaklık
- Sümela Tabak Dispenseri

BUFFET SYSTEMS

Galata Model

- Galata Notr Service Units
- Galata Notr Service Units (With Sneeze Guard)
- Galata Cold Service Units (With Sneeze Guard)
- Galata S/S Cold Service Units (With Sneeze Guard)
- Galata Hot Service Units (With Sneeze Guard)
- Galata Hot Service Units (Chafing Dish)
- Galata Soup Service Units
- Galata Bread Service Units
- Galata Plate Dispenser Unit
- Galata Plate Dispenser

Kapadokya Model

- Kapadokya Notr Service Units
- Kapadokya Notr Service Units (With Sneeze Guard)
- Kapadokya Cold Service Units (With Sneeze Guard)
- Kapadokya S/S Cold Service Units (With Sneeze Guard)
- Kapadokya Hot Service Units (With Sneeze Guard)
- Kapadokya Hot Service Units (Chafing Dish)
- Kapadokya Soup Service Units
- Kapadokya Bread Service Units
- Kapadokya Plate Dispenser Unit
- Kapadokya Plate Dispenser

Sümela Model

- Sümela Notr Service Units
- Sümela Notr Service Units (With Sneeze Guard)
- Sümela Cold Service Units (With Sneeze Guard)
- Sümela S/S Cold Service Units (With Sneeze Guard)
- Sümela Hot Service Units (With Sneeze Guard)
- Sümela Hot Service Units (Chafing Dish)
- Sümela Soup Service Units
- Sümela Bread Service Units
- Sümela Plate Dispenser Unit
- Sümela Plate Dispenser



GALATA MODEL

Galata



Kod Code	Ürün Adı Description	Ebatlar Dimension a x b x c (mm)
AND.ANTR.01	Galata Nötr Servis Ünitesi Galata Notr Service Units	1000x900x900
AND.ANTR.02	Galata Nötr Servis Ünitesi Galata Notr Service Units	1200x900x900
AND.ANTR.03	Galata Nötr Servis Ünitesi Galata Notr Service Units	1400x900x900
AND.ANTR.04	Galata Nötr Servis Ünitesi Galata Notr Service Units	1600x900x900
AND.ANTR.05	Galata Nötr Servis Ünitesi Galata Notr Service Units	1800x900x900
AND.ANTR.06	Galata Nötr Servis Ünitesi Galata Notr Service Units	2000x900x900
AND.ANTR.07	Galata Nötr Servis Ünitesi Galata Notr Service Units	2200x900x900
AND.ANTR.08	Galata Nötr Servis Ünitesi Galata Notr Service Units	2400x900x900

TEKNİK ÖZELLİKLER

- Granit üst tabla.
- Dekoratif ahşap kaplama.
- Paslanmaz alt baza.
- Tabak rafı.

TECHNICAL SPECIFICATIONS

- Granite table.
- Wooden Decoration.
- Stainless steel frame.
- Plate shelve.

Galata



Kod Code	Ürün Adı Description	Ebatlar Dimension a x b x c (mm)
AND.ANTR-N.01	Galata Nötr Servis Ünitesi Nefeslikli Galata Nötr Service Units With Sneeze Guard	1000x900x900/1550
AND.ANTR-N.02	Galata Nötr Servis Ünitesi Nefeslikli Galata Nötr Service Units With Sneeze Guard	1200x900x900/1550
AND.ANTR-N.03	Galata Nötr Servis Ünitesi Nefeslikli Galata Nötr Service Units With Sneeze Guard	1400x900x900/1550
AND.ANTR-N.04	Galata Nötr Servis Ünitesi Nefeslikli Galata Nötr Service Units With Sneeze Guard	1600x900x900/1550
AND.ANTR-N.05	Galata Nötr Servis Ünitesi Nefeslikli Galata Nötr Service Units With Sneeze Guard	1800x900x900/1550
AND.ANTR-N.06	Galata Nötr Servis Ünitesi Nefeslikli Galata Nötr Service Units With Sneeze Guard	2000x900x900/1550
AND.ANTR-N.07	Galata Nötr Servis Ünitesi Nefeslikli Galata Nötr Service Units With Sneeze Guard	2200x900x900/1550
AND.ANTR-N.08	Galata Nötr Servis Ünitesi Nefeslikli Galata Nötr Service Units With Sneeze Guard	2400x900x900/1550

TEKNİK ÖZELLİKLER

- Granit üst tabla.
- Dekoratif ahşap kaplama.
- Paslanmaz alt baza.
- Bombe camlı nefeslik.
- Led aydınlatma.
- Tabak rafı.

TECHNICAL SPECIFICATIONS

- Granite table.
- Wooden Decoration.
- Stainless steel frame.
- With sneeze guard.
- Led lighting.
- Plate shelve.

Açık Büfe Sistemleri Buffet Systems

Galata Soğuk Servis Üniteleri (Nefeslikli) Galata Cold Service Units (With Sneeze Guard)

andora

CE

Galata



Kod Code	Ürün Adı Description	Ebatlar Dimension a x b x c (mm)
AND.ASSU-N.01	Galata Soğuk Servis Ünitesi Nefeslikli Galata Cold Service Units With Sneeze Guard	1000x900x900/1550
AND.ASSU-N.02	Galata Soğuk Servis Ünitesi Nefeslikli Galata Cold Service Units With Sneeze Guard	1200x900x900/1550
AND.ASSU-N.03	Galata Soğuk Servis Ünitesi Nefeslikli Galata Cold Service Units With Sneeze Guard	1400x900x900/1550
AND.ASSU-N.04	Galata Soğuk Servis Ünitesi Nefeslikli Galata Cold Service Units With Sneeze Guard	1600x900x900/1550
AND.ASSU-N.05	Galata Soğuk Servis Ünitesi Nefeslikli Galata Cold Service Units With Sneeze Guard	1800x900x900/1550
AND.ASSU-N.06	Galata Soğuk Servis Ünitesi Nefeslikli Galata Cold Service Units With Sneeze Guard	2000x900x900/1550
AND.ASSU-N.07	Galata Soğuk Servis Ünitesi Nefeslikli Galata Cold Service Units With Sneeze Guard	2200x900x900/1550
AND.ASSU-N.08	Galata Soğuk Servis Ünitesi Nefeslikli Galata Cold Service Units With Sneeze Guard	2400x900x900/1550

TEKNİK ÖZELLİKLER

- Granit soğutmalı üst tabla.
- Dekoratif ahşap kaplama.
- Paslanmaz alt baza.
- Bombe camlı nefeslik.
- Led aydınlatma.
- Tabak rafı.

TECHNICAL SPECIFICATIONS

- Granite top cold table.
- Wooden Decoration.
- Stainless steel frame.
- With sneeze guard.
- Led lighting.
- Plate shelve.

Galata



Kod Code	Ürün Adı Description	Ebatlar Dimension a x b x c (mm)
AND.AP.SSU.01	Galata Paslanmaz Soğuk Servis Ünitesi Nefeslikli Galata S/S Cold Service Units With Sneeze Guard	1000x900x900/1550
AND.AP.SSU.02	Galata Paslanmaz Soğuk Servis Ünitesi Nefeslikli Galata S/S Cold Service Units With Sneeze Guard	1200x900x900/1550
AND.AP.SSU.03	Galata Paslanmaz Soğuk Servis Ünitesi Nefeslikli Galata S/S Cold Service Units With Sneeze Guard	1400x900x900/1550
AND.AP.SSU.04	Galata Paslanmaz Soğuk Servis Ünitesi Nefeslikli Galata S/S Cold Service Units With Sneeze Guard	1600x900x900/1550
AND.AP.SSU.05	Galata Paslanmaz Soğuk Servis Ünitesi Nefeslikli Galata S/S Cold Service Units With Sneeze Guard	1800x900x900/1550
AND.AP.SSU.06	Galata Paslanmaz Soğuk Servis Ünitesi Nefeslikli Galata S/S Cold Service Units With Sneeze Guard	2000x900x900/1550
AND.AP.SSU.07	Galata Paslanmaz Soğuk Servis Ünitesi Nefeslikli Galata S/S Cold Service Units With Sneeze Guard	2200x900x900/1550
AND.AP.SSU.08	Galata Paslanmaz Soğuk Servis Ünitesi Nefeslikli Galata S/S Cold Service Units With Sneeze Guard	2400x900x900/1550

TEKNİK ÖZELLİKLER

- Granit üst tabla.
- Paslanmaz soğutmalı üst tabla.
- Dekoratif ahşap kaplama.
- Paslanmaz alt baza.
- Bombe camlı nefeslik.
- Led aydınlatma.
- Tabak rafı.

TECHNICAL SPECIFICATIONS

- Granite table.
- Stainless steel cold table.
- Wooden Decoration.
- Stainless steel frame.
- With sneeze guard.
- Led lighting.
- Plate shelve.

Açık Büfe Sistemleri Buffet Systems

Galata Sıcak Servis Üniteleri (Nefeslikli) Galata Hot Service Units (With Sneeze Guard)

andora

CE

Galata



Kod Code	Ürün Adı Description	Ebatlar Dimension a x b x c (mm)	Kapasite Capacity (gn)
AND.ASSB.01	Galata Sıcak Servis Ünitesi Nefeslikli Galata Hot Service Units With Sneeze Guard	1200x900x900/1550	2 x 1/1 Gn
AND.ASSB.02	Galata Sıcak Servis Ünitesi Nefeslikli Galata Hot Service Units With Sneeze Guard	1600x900x900/1550	3 x 1/1 Gn
AND.ASSB.03	Galata Sıcak Servis Ünitesi Nefeslikli Galata Hot Service Units With Sneeze Guard	2000x900x900/1550	4 x 1/1 Gn
AND.ASSB.04	Galata Sıcak Servis Ünitesi Nefeslikli Galata Hot Service Units With Sneeze Guard	2400x900x900/1550	5 x 1/1 Gn

TEKNİK ÖZELLİKLER

- Granit üst tabla.
- Dekoratif ahşap kaplama.
- Paslanmaz alt baza.
- Bombe camlı nefeslik.
- Led aydınlatma.
- Tabak rafı.
- Paslanmaz çelik havuz.

TECHNICAL SPECIFICATIONS

- Granite top table.
- Wooden Decoration.
- Stainless steel frame.
- With sneeze guard.
- Led lighting.
- Plate shelf.
- Stainless steel well.

Standart üretimimizde küvet bulunmamaktadır. / Standart product does not have containers.

Galata



Kod Code	Ürün Adı Description	Ebatlar Dimension a x b x c (mm)	Kapasite Capacity (gn)
AND.ASSC-N.01	Galata Sıcak Servis Ünitesi Nefeslikli Galata Hot Service Units Chafing Dish	1200x900x900/1550	1/1 Gn Chafing Dish
AND.ASSC-N.02	Galata Sıcak Servis Ünitesi Nefeslikli Galata Hot Service Units Chafing Dish	1800x900x900/1550	2x(1/1 Gn) Chafing Dish
AND.ASSC-N.03	Galata Sıcak Servis Ünitesi Nefeslikli Galata Hot Service Units Chafing Dish	2600x900x900/1550	3x(1/1 Gn) Chafing Dish

TEKNİK ÖZELLİKLER

- Granit üst tabla.
- Dekoratif ahşap kaplama.
- Paslanmaz alt baza.
- Bombe camlı nefeslik.
- Led aydınlatma.
- Tabak rafı.

TECHNICAL SPECIFICATIONS

- Granite top table.
- Wooden Decoration.
- Stainless steel frame.
- With sneeze guard.
- Led lighting.
- Plate shelve.

Açık Büfe Sistemleri Buffet Systems

Galata Sıcak Servis Üniteleri (Reşolu) Galata Hot Service Units (Chafing Dish)

andora

CE

Galata



Kod Code	Ürün Adı Description	Ebatlar Dimension a x b x c (mm)	Kapasite Capacity (gn)
AND.ASSC.01	Galata Sıcak Servis Ünitesi Reşolu Galata Hot Service Units Chafing Dish	1200x900x900	1x1/1 Gn Chafing Dish
AND.ASSC.02	Galata Sıcak Servis Ünitesi Reşolu Galata Hot Service Units Chafing Dish	1800x900x900	2x1/1 Gn Chafing Dish
AND.ASSC.03	Galata Sıcak Servis Ünitesi Reşolu Galata Hot Service Units Chafing Dish	2600x900x900	3x1/1 Gn Chafing Dish

TEKNİK ÖZELLİKLER

- Granit üst tabla.
- Dekoratif ahşap kaplama.
- Paslanmaz alt baza.
- Tabak rafı.

TECHNICAL SPECIFICATIONS

- Granite top table.
- Wooden Decoration.
- Stainless steel frame.
- Plate shelve.

Galata



Kod Code	Ürün Adı Description	Ebatlar Dimension a x b x c (mm)	Kapasite Capacity (gn)
AND.ACSU.01	Galata Çorba Servis Ünitesi Galata Soup Service Units	1400x900x900	1 Çorbalık Soup Dispenser
AND.ACSU.02	Galata Çorba Servis Ünitesi Galata Soup Service Units	2000x900x900	2 Çorbalık Soup Dispenser
AND.ACSU.03	Galata Çorba Servis Ünitesi Galata Soup Service Units	2400x900x900	3 Çorbalık Soup Dispenser

TEKNİK ÖZELLİKLER

- Granit üst tabla.
- Dekoratif ahşap kaplama.
- Paslanmaz alt baza.
- Tabak rafı.

TECHNICAL SPECIFICATIONS

- Granite top table.
- Wooden Decoration.
- Stainless steel frame.
- Plate shelve.

Galata



Kod Code	Ürün Adı Description	Ebatlar Dimension a x b x c (mm)
AND.AESU.01	Galata Ekmek Servis Ünitesi Galata Bread Service Units	1000x900x900
AND.AESU.02	Galata Ekmek Servis Ünitesi Galata Bread Service Units	1200x900x900
AND.AESU.03	Galata Ekmek Servis Ünitesi Galata Bread Service Units	1400x900x900
AND.AESU.04	Galata Ekmek Servis Ünitesi Galata Bread Service Units	1600x900x900
AND.AESU.05	Galata Nötr Servis Ünitesi Galata Nötr Service Units	1800x900x900
AND.AESU.06	Galata Ekmek Servis Ünitesi Galata Bread Service Units	2000x900x900
AND.AESU.07	Galata Ekmek Servis Ünitesi Galata Bread Service Units	2200x900x900
AND.AESU.08	Galata Ekmek Servis Ünitesi Galata Bread Service Units	2400x900x900

TEKNİK ÖZELLİKLER

- Granit üst tabla.
- Dekoratif ahşap kaplama.
- Paslanmaz alt baza.
- Tabak rafı.

TECHNICAL SPECIFICATIONS

- Granite top table.
- Wooden Decoration.
- Stainless steel frame.
- Plate shelf.

Galata



Kod Code	Ürün Adı Description	Ebatlar Dimension a x b x c (mm)
AND.AUT.01	Galata U Form Tabaklık Galata Plate Dispenser Unit	1100x900x900

TEKNİK ÖZELLİKLER

- Granit üst tabla.
- Dekoratif ahşap kaplama.
- Paslanmaz alt baza.

TECHNICAL SPECIFICATIONS

- Granite top table.
- Wooden Decoration.
- Stainless steel frame.



Galata



Kod Code	Ürün Adı Description	Ebatlar Dimension a x b x c (mm)	Kapasite Capacity
AND.ATD.01	Galata Tabak Dispenseri Galata Plate Dispenser	1100x900x900	2 Tabaklı / Plate Isıtmalı / Heated
AND.ATD.02	Galata Tabak Dispenseri Galata Plate Dispenser	1100x900x900	2 Tabaklı / Plate Nötr / Neutral

TEKNİK ÖZELLİKLER

- Granit üst tabla.
- Dekoratif ahşap kaplama.
- Paslanmaz alt baza.

TECHNICAL SPECIFICATIONS

- Granite top table.
- Wooden Decoration.
- Stainless steel frame.



KAPADOKYA MODEL

Kapadokya



Kod Code	Ürün Adı Description	Ebatlar Dimension a x b x c (mm)
AND.ANTR.01	Kapadokya Nötr Servis Ünitesi Kapadokya Nötr Service Units	1000x900x900
AND.ANTR.02	Kapadokya Nötr Servis Ünitesi Kapadokya Nötr Service Units	1200x900x900
AND.ANTR.03	Kapadokya Nötr Servis Ünitesi Kapadokya Nötr Service Units	1400x900x900
AND.ANTR.04	Kapadokya Nötr Servis Ünitesi Kapadokya Nötr Service Units	1600x900x900
AND.ANTR.05	Kapadokya Nötr Servis Ünitesi Kapadokya Nötr Service Units	1800x900x900
AND.ANTR.06	Kapadokya Nötr Servis Ünitesi Kapadokya Nötr Service Units	2000x900x900
AND.ANTR.07	Kapadokya Nötr Servis Ünitesi Kapadokya Nötr Service Units	2200x900x900
AND.ANTR.08	Kapadokya Nötr Servis Ünitesi Kapadokya Nötr Service Units	2400x900x900

TEKNİK ÖZELLİKLER

- Granit üst tabla.
- Dekoratif ahşap kaplama.
- Paslanmaz alt baza.

TECHNICAL SPECIFICATIONS

- Granite table.
- Wooden Decoration.
- Stainless steel frame.



Kod Code	Ürün Adı Description	Ebatlar Dimension a x b x c (mm)
AND.ANTR-N.01	Kapadokya Nötr Servis Ünitesi Nefeslikli Kapadokya Nötr Service Units With Sneeze Guard	1000x900x900/1550
AND.ANTR-N.02	Kapadokya Nötr Servis Ünitesi Nefeslikli Kapadokya Nötr Service Units With Sneeze Guard	1200x900x900/1550
AND.ANTR-N.03	Kapadokya Nötr Servis Ünitesi Nefeslikli Kapadokya Nötr Service Units With Sneeze Guard	1400x900x900/1550
AND.ANTR-N.04	Kapadokya Nötr Servis Ünitesi Nefeslikli Kapadokya Nötr Service Units With Sneeze Guard	1600x900x900/1550
AND.ANTR-N.05	Kapadokya Nötr Servis Ünitesi Nefeslikli Kapadokya Nötr Service Units With Sneeze Guard	1800x900x900/1550
AND.ANTR-N.06	Kapadokya Nötr Servis Ünitesi Nefeslikli Kapadokya Nötr Service Units With Sneeze Guard	2000x900x900/1550
AND.ANTR-N.07	Kapadokya Nötr Servis Ünitesi Nefeslikli Kapadokya Nötr Service Units With Sneeze Guard	2200x900x900/1550
AND.ANTR-N.08	Kapadokya Nötr Servis Ünitesi Nefeslikli Kapadokya Nötr Service Units With Sneeze Guard	2400x900x900/1550

TEKNİK ÖZELLİKLER

- Granit üst tabla.
- Dekoratif ahşap kaplama.
- Paslanmaz alt baza.
- Bombe camlı nefeslik.
- Led aydınlatma.

TECHNICAL SPECIFICATIONS

- Granite table.
- Wooden Decoration.
- Stainless steel frame.
- With sneeze guard.
- Led lighting.

Açık Büfe Sistemleri Buffet Systems

Kapadokya Soğuk Servis Üniteleri (Nefeslikli) Kapadokya Cold Service Units (With Sneeze Guard)

andora

CE



Kod Code	Ürün Adı Description	Ebatlar Dimension a x b x c (mm)
AND.ASSU-N.01	Kapadokya Soğuk Servis Ünitesi Nefeslikli Kapadokya Cold Service Units With Sneeze Guard	1000x900x900/1550
AND.ASSU-N.02	Kapadokya Soğuk Servis Ünitesi Nefeslikli Kapadokya Cold Service Units With Sneeze Guard	1200x900x900/1550
AND.ASSU-N.03	Kapadokya Soğuk Servis Ünitesi Nefeslikli Kapadokya Cold Service Units With Sneeze Guard	1400x900x900/1550
AND.ASSU-N.04	Kapadokya Soğuk Servis Ünitesi Nefeslikli Kapadokya Cold Service Units With Sneeze Guard	1600x900x900/1550
AND.ASSU-N.05	Kapadokya Soğuk Servis Ünitesi Nefeslikli Kapadokya Cold Service Units With Sneeze Guard	1800x900x900/1550
AND.ASSU-N.06	Kapadokya Soğuk Servis Ünitesi Nefeslikli Kapadokya Cold Service Units With Sneeze Guard	2000x900x900/1550
AND.ASSU-N.07	Kapadokya Soğuk Servis Ünitesi Nefeslikli Kapadokya Cold Service Units With Sneeze Guard	2200x900x900/1550
AND.ASSU-N.08	Kapadokya Soğuk Servis Ünitesi Nefeslikli Kapadokya Cold Service Units With Sneeze Guard	2400x900x900/1550

TEKNİK ÖZELLİKLER

- Granit soğutmalı üst tabla.
- Dekoratif ahşap kaplama.
- Paslanmaz alt baza.
- Bombe camlı nefeslik.
- Led aydınlatma.

TECHNICAL SPECIFICATIONS

- Granite top cold table.
- Wooden Decoration.
- Stainless steel frame.
- With sneeze guard.
- Led lighting.



Kod Code	Ürün Adı Description	Ebatlar Dimension a x b x c (mm)
AND.AP.SSU.01	Kapadokya Paslanmaz Soğuk Servis Ünitesi Nefeslikli Kapadokya S/S Cold Service Units With Sneeze Guard	1000x900x900/1550
AND.AP.SSU.02	Kapadokya Paslanmaz Soğuk Servis Ünitesi Nefeslikli Kapadokya S/S Cold Service Units With Sneeze Guard	1200x900x900/1550
AND.AP.SSU.03	Kapadokya Paslanmaz Soğuk Servis Ünitesi Nefeslikli Kapadokya S/S Cold Service Units With Sneeze Guard	1400x900x900/1550
AND.AP.SSU.04	Kapadokya Paslanmaz Soğuk Servis Ünitesi Nefeslikli Kapadokya S/S Cold Service Units With Sneeze Guard	1600x900x900/1550
AND.AP.SSU.05	Kapadokya Paslanmaz Soğuk Servis Ünitesi Nefeslikli Kapadokya S/S Cold Service Units With Sneeze Guard	1800x900x900/1550
AND.AP.SSU.06	Kapadokya Paslanmaz Soğuk Servis Ünitesi Nefeslikli Kapadokya S/S Cold Service Units With Sneeze Guard	2000x900x900/1550
AND.AP.SSU.07	Kapadokya Paslanmaz Soğuk Servis Ünitesi Nefeslikli Kapadokya S/S Cold Service Units With Sneeze Guard	2200x900x900/1550
AND.AP.SSU.08	Kapadokya Paslanmaz Soğuk Servis Ünitesi Nefeslikli Kapadokya S/S Cold Service Units With Sneeze Guard	2400x900x900/1550

TEKNİK ÖZELLİKLER

- Granit üst tabla.
- Paslanmaz soğutmalı üst tabla.
- Dekoratif ahşap kaplama.
- Paslanmaz alt baza.
- Bombe camlı nefeslik.
- Led aydınlatma.
- Tabak rafı.

TECHNICAL SPECIFICATIONS

- Granite table.
- Stainless steel cold table.
- Wooden Decoration.
- Stainless steel frame.
- With sneeze guard.
- Led lighting.
- Plate shelve.

Açık Büfe Sistemleri Buffet Systems

Kapadokya Sıcak Servis Üniteleri (Nefeslikli) Kapadokya Hot Service Units (With Sneeze Guard)

andora

CE

Kapadokya



Kod Code	Ürün Adı Description	Ebatlar Dimension a x b x c (mm)	Kapasite Capacity (gn)
KPD.SSB.01	Kapadokya Sıcak Servis Üniteleri Nefeslikli Kapadokya Hot Service Units With Sneeze Guard	1200x900x900/1550	2 x 1/1 Gn
KPD.SSB.02	Kapadokya Sıcak Servis Üniteleri Nefeslikli Kapadokya Hot Service Units With Sneeze Guard	1600x900x900/1550	3 x 1/1 Gn
KPD.SSB.03	Kapadokya Sıcak Servis Üniteleri Nefeslikli Kapadokya Hot Service Units With Sneeze Guard	2000x900x900/1550	4 x 1/1 Gn
KPD.SSB.04	Kapadokya Sıcak Servis Üniteleri Nefeslikli Kapadokya Hot Service Units With Sneeze Guard	2400x900x900/1550	5 x 1/1 Gn

TEKNİK ÖZELLİKLER

- Granit üst tabla.
- Dekoratif ahşap kaplama.
- Paslanmaz alt baza.
- Bombe camlı nefeslik.
- Led aydınlatma.
- Paslanmaz çelik havuz.

TECHNICAL SPECIFICATIONS

- Granite top table.
- Wooden Decoration.
- Stainless steel frame.
- With sneeze guard.
- Led lighting.
- Stainless steel well.

Standart üretimimizde küvet bulunmamaktadır. / Standart product does not have containers.



Kod Code	Ürün Adı Description	Ebatlar Dimension a x b x c (mm)	Kapasite Capacity (gn)
AND.ASSC-N.01	Kapadokya Sıcak Servis Ünitesi Nefeslikli Kapadokya Hot Service Units Chafing Dish	1200x900x900/1550	1/1 Gn Chafing Dish
AND.ASSC-N.02	Kapadokya Sıcak Servis Ünitesi Nefeslikli Kapadokya Hot Service Units Chafing Dish	1800x900x900/1550	2x(1/1 Gn) Chafing Dish
AND.ASSC-N.03	Kapadokya Sıcak Servis Ünitesi Nefeslikli Kapadokya Hot Service Units Chafing Dish	2600x900x900/1550	3x(1/1 Gn) Chafing Dish

TEKNİK ÖZELLİKLER

- Granit üst tabla.
- Dekoratif ahşap kaplama.
- Paslanmaz alt baza.
- Bombe camlı nefeslik.
- Led aydınlatma.

TECHNICAL SPECIFICATIONS

- Granite top table.
- Wooden Decoration.
- Stainless steel frame.
- With sneeze guard.
- Led lighting.

Açık Büfe Sistemleri
Buffet Systems

Kapadokya Sıcak Servis Üniteleri (Reşolu)
Kapadokya Hot Service Units (Chafing Dish)

andora

CE

Kapadokya



Kod Code	Ürün Adı Description	Ebatlar Dimension a x b x c (mm)	Kapasite Capacity (gn)
AND.ASSC.01	Kapadokya Sıcak Servis Ünitesi Reşolu Kapadokya Hot Service Units Chafing Dish	1200x900x900	1x1/1 Gn Chafing Dish
AND.ASSC.02	Kapadokya Sıcak Servis Ünitesi Reşolu Kapadokya Hot Service Units Chafing Dish	1800x900x900	2x1/1 Gn Chafing Dish
AND.ASSC.03	Kapadokya Sıcak Servis Ünitesi Reşolu Kapadokya Hot Service Units Chafing Dish	2600x900x900	3x1/1 Gn Chafing Dish

TEKNİK ÖZELLİKLER

- Granit üst tabla.
- Dekoratif ahşap kaplama.
- Paslanmaz alt baza.

TECHNICAL SPECIFICATIONS

- Granite top table.
- Wooden Decoration.
- Stainless steel frame.

Kapadokya



Kod Code	Ürün Adı Description	Ebatlar Dimension a x b x c (mm)	Kapasite Capacity (gn)
AND.ACSU.01	Kapadokya orba Servis Ünitesi Kapadokya Soup Service Units	1400x900x900	1 orbalık Soup Dispenser
AND.ACSU.02	Kapadokya orba Servis Ünitesi Kapadokya Soup Service Units	2000x900x900	2 orbalık Soup Dispenser
AND.ACSU.03	Kapadokya orba Servis Ünitesi Kapadokya Soup Service Units	2400x900x900	3 orbalık Soup Dispenser

TEKNİK ÖZELLİKLER

- Granit üst tabla.
- Dekoratif ahşap kaplama.
- Paslanmaz alt baza.

TECHNICAL SPECIFICATIONS

- Granite top table.
- Wooden Decoration.
- Stainless steel frame.

Kapadokya



Kod Code	Ürün Adı Description	Ebatlar Dimension a x b x c (mm)
AND.AESU.01	Kapadokya Ekmek Servis Ünitesi Kapadokya Bread Service Units	1000x900x900
AND.AESU.02	Kapadokya Ekmek Servis Ünitesi Kapadokya Bread Service Units	1200x900x900
AND.AESU.03	Kapadokya Ekmek Servis Ünitesi Kapadokya Bread Service Units	1400x900x900
AND.AESU.04	Kapadokya Ekmek Servis Ünitesi Kapadokya Bread Service Units	1600x900x900
AND.AESU.05	Kapadokya Ekmek Servis Ünitesi Kapadokya Bread Service Units	1800x900x900
AND.AESU.06	Kapadokya Ekmek Servis Ünitesi Kapadokya Bread Service Units	2000x900x900
AND.AESU.07	Kapadokya Ekmek Servis Ünitesi Kapadokya Bread Service Units	2200x900x900
AND.AESU.08	Kapadokya Ekmek Servis Ünitesi Kapadokya Bread Service Units	2400x900x900

TEKNİK ÖZELLİKLER

- Granit üst tabla.
- Dekoratif ahşap kaplama.
- Paslanmaz alt baza.

TECHNICAL SPECIFICATIONS

- Granite top table.
- Wooden Decoration.
- Stainless steel frame.

Kapadokya



Kod Code	Ürün Adı Description	Ebatlar Dimension
AND.AUT.01	Kapadokya U Form Tabaklık Kapadokya Plate Dispenser Unit	a x b x c (mm) 1100x900x900

TEKNİK ÖZELLİKLER

- Granit üst tabla.
- Dekoratif ahşap kaplama.
- Paslanmaz alt baza.

TECHNICAL SPECIFICATIONS

- Granite top table.
- Wooden Decoration.
- Stainless steel frame.



Kapadokya



Kod Code	Ürün Adı Description	Ebatlar Dimension a x b x c (mm)	Kapasite Capacity
AND.ATD.01	Kapadokya Tabak Dispenseri Kapadokya Plate Dispenser	1100x900x900	2 Tabaklı / Plate Isıtılmalı / Heated
AND.ATD.02	Kapadokya Tabak Dispenseri Kapadokya Plate Dispenser	1100x900x900	2 Tabaklı / Plate Nötr / Neutral

TEKNİK ÖZELLİKLER

- Granit üst tabla.
- Dekoratif ahşap kaplama.
- Paslanmaz alt baza.

TECHNICAL SPECIFICATIONS

- Granite top table.
- Wooden Decoration.
- Stainless steel frame.



SÜMELA MODEL

Sümela



Kod Code	Ürün Adı Description	Ebatlar Dimension a x b x c (mm)
AND.S.ANTR.01	Sümela Nötr Servis Ünitesi Sümela Notr Service Units	1000x900x900
AND.S.ANTR.02	Sümela Nötr Servis Ünitesi Sümela Notr Service Units	1200x900x900
AND.S.ANTR.03	Sümela Nötr Servis Ünitesi Sümela Notr Service Units	1400x900x900
AND.S.ANTR.04	Sümela Nötr Servis Ünitesi Sümela Notr Service Units	1600x900x900
AND.S.ANTR.05	Sümela Nötr Servis Ünitesi Sümela Notr Service Units	1800x900x900
AND.S.ANTR.06	Sümela Nötr Servis Ünitesi Sümela Notr Service Units	2000x900x900
AND.S.ANTR.07	Sümela Nötr Servis Ünitesi Sümela Notr Service Units	2200x900x900
AND.S.ANTR.08	Sümela Nötr Servis Ünitesi Sümela Notr Service Units	2400x900x900

TEKNİK ÖZELLİKLER

- Granit üst tabla.
- Dekoratif ahşap kaplama.
- Paslanmaz alt baza.
- Tabak rafı.

TECHNICAL SPECIFICATIONS

- Granite table.
- Wooden Decoration.
- Stainless steel frame.
- Plate shelve.

Sümela



Kod Code	Ürün Adı Description	Ebatlar Dimension a x b x c (mm)
AND.S.ANTR-N.01	Sümela Nötr Servis Ünitesi Nefeslikli Sümela Nötr Service Units With Sneeze Guard	1000x900x900/1550
AND.S.ANTR-N.02	Sümela Nötr Servis Ünitesi Nefeslikli Sümela Nötr Service Units With Sneeze Guard	1200x900x900/1550
AND.S.ANTR-N.03	Sümela Nötr Servis Ünitesi Nefeslikli Sümela Nötr Service Units With Sneeze Guard	1400x900x900/1550
AND.S.ANTR-N.04	Sümela Nötr Servis Ünitesi Nefeslikli Sümela Nötr Service Units With Sneeze Guard	1600x900x900/1550
AND.S.ANTR-N.05	Sümela Nötr Servis Ünitesi Nefeslikli Sümela Nötr Service Units With Sneeze Guard	1800x900x900/1550
AND.S.ANTR-N.06	Sümela Nötr Servis Ünitesi Nefeslikli Sümela Nötr Service Units With Sneeze Guard	2000x900x900/1550
AND.S.ANTR-N.07	Sümela Nötr Servis Ünitesi Nefeslikli Sümela Nötr Service Units With Sneeze Guard	2200x900x900/1550
AND.S.ANTR-N.08	Sümela Nötr Servis Ünitesi Nefeslikli Sümela Nötr Service Units With Sneeze Guard	2400x900x900/1550

TEKNİK ÖZELLİKLER

- Granit üst tabla.
- Dekoratif ahşap kaplama.
- Paslanmaz alt baza.
- Bombe camlı nefeslik.
- Led aydınlatma.
- Tabak rafı.

TECHNICAL SPECIFICATIONS

- Granite table.
- Wooden Decoration.
- Stainless steel frame.
- With sneeze guard.
- Led lighting.
- Plate shelve.

Açık Büfe Sistemleri Buffet Systems

Sümela Soğuk Servis Üniteleri (Nefeslikli) Sümela Cold Service Units (With Sneeze Guard)

andora

CE

Sümela



Kod Code	Ürün Adı Description	Ebatlar Dimension a x b x c (mm)
AND.S.ASSU-N.01	Sümela Soğuk Servis Ünitesi Nefeslikli Sümela Cold Service Units With Sneeze Guard	1000x900x900/1550
AND.S.ASSU-N.02	Sümela Soğuk Servis Ünitesi Nefeslikli Sümela Cold Service Units With Sneeze Guard	1200x900x900/1550
AND.S.ASSU-N.03	Sümela Soğuk Servis Ünitesi Nefeslikli Sümela Cold Service Units With Sneeze Guard	1400x900x900/1550
AND.S.ASSU-N.04	Sümela Soğuk Servis Ünitesi Nefeslikli Sümela Cold Service Units With Sneeze Guard	1600x900x900/1550
AND.S.ASSU-N.05	Sümela Soğuk Servis Ünitesi Nefeslikli Sümela Cold Service Units With Sneeze Guard	1800x900x900/1550
AND.S.ASSU-N.06	Sümela Soğuk Servis Ünitesi Nefeslikli Sümela Cold Service Units With Sneeze Guard	2000x900x900/1550
AND.S.ASSU-N.07	Sümela Soğuk Servis Ünitesi Nefeslikli Sümela Cold Service Units With Sneeze Guard	2200x900x900/1550
AND.S.ASSU-N.08	Sümela Soğuk Servis Ünitesi Nefeslikli Sümela Cold Service Units With Sneeze Guard	2400x900x900/1550

TEKNİK ÖZELLİKLER

- Granit soğutmalı üst tabla.
- Dekoratif ahşap kaplama.
- Paslanmaz alt baza.
- Bombe camlı nefeslik.
- Led aydınlatma.
- Tabak rafı.

TECHNICAL SPECIFICATIONS

- Granite top cold table.
- Wooden Decoration.
- Stainless steel frame.
- With sneeze guard.
- Led lighting.
- Plate shelf.

Sümela



Kod Code	Ürün Adı Description	Ebatlar Dimension a x b x c (mm)
AND.S.AP.SSU.01	Sümela Paslanmaz Soğuk Servis Ünitesi Nefeslikli Sümela S/S Cold Service Units With Sneeze Guard	1000x900x900/1550
AND.S.AP.SSU.02	Sümela Paslanmaz Soğuk Servis Ünitesi Nefeslikli Sümela S/S Cold Service Units With Sneeze Guard	1200x900x900/1550
AND.S.AP.SSU.03	Sümela Paslanmaz Soğuk Servis Ünitesi Nefeslikli Sümela S/S Cold Service Units With Sneeze Guard	1400x900x900/1550
AND.S.AP.SSU.04	Sümela Paslanmaz Soğuk Servis Ünitesi Nefeslikli Sümela S/S Cold Service Units With Sneeze Guard	1600x900x900/1550
AND.S.AP.SSU.05	Sümela Paslanmaz Soğuk Servis Ünitesi Nefeslikli Sümela S/S Cold Service Units With Sneeze Guard	1800x900x900/1550
AND.S.AP.SSU.06	Sümela Paslanmaz Soğuk Servis Ünitesi Nefeslikli Sümela S/S Cold Service Units With Sneeze Guard	2000x900x900/1550
AND.S.AP.SSU.07	Sümela Paslanmaz Soğuk Servis Ünitesi Nefeslikli Sümela S/S Cold Service Units With Sneeze Guard	2200x900x900/1550
AND.S.AP.SSU.08	Sümela Paslanmaz Soğuk Servis Ünitesi Nefeslikli Sümela S/S Cold Service Units With Sneeze Guard	2400x900x900/1550

TEKNİK ÖZELLİKLER

- Granit üst tabla.
- Paslanmaz soğutmalı üst tabla.
- Dekoratif ahşap kaplama.
- Paslanmaz alt baza.
- Bombe camlı nefeslik.
- Led aydınlatma.
- Tabak rafı.

TECHNICAL SPECIFICATIONS

- Granite table.
- Stainless steel cold table.
- Wooden Decoration.
- Stainless steel frame.
- With sneeze guard.
- Led lighting.
- Plate shelve.

Açık Büfe Sistemleri Buffet Systems

Sümela Sıcak Servis Üniteleri (Nefeslikli) Sümela Hot Service Units (With Sneeze Guard)

andora

CE

Sümela



Kod Code	Ürün Adı Description	Ebatlar Dimension a x b x c (mm)	Kapasite Capacity (gn)
AND.ASSB.01	Sümela Sıcak Servis Ünitesi Nefeslikli Sümela Hot Service Units With Sneeze Guard	1200x900x900/1550	2 x 1/1 Gn
AND.ASSB.02	Sümela Sıcak Servis Ünitesi Nefeslikli Sümela Hot Service Units With Sneeze Guard	1600x900x900/1550	3 x 1/1 Gn
AND.ASSB.03	Sümela Sıcak Servis Ünitesi Nefeslikli Sümela Hot Service Units With Sneeze Guard	2000x900x900/1550	4 x 1/1 Gn
AND.ASSB.04	Sümela Sıcak Servis Ünitesi Nefeslikli Sümela Hot Service Units With Sneeze Guard	2400x900x900/1550	5 x 1/1 Gn

TEKNİK ÖZELLİKLER

- Granit üst tabla.
- Dekoratif ahşap kaplama.
- Paslanmaz alt baza.
- Bombe camlı nefeslik.
- Led aydınlatma.
- Tabak rafı.
- Paslanmaz çelik havuz.

TECHNICAL SPECIFICATIONS

- Granite top table.
- Wooden Decoration.
- Stainless steel frame.
- With sneeze guard.
- Led lighting.
- Plate shelf.
- Stainless steel well.

Standart üretimimizde küvet bulunmamaktadır. / Standart product does not have containers.

Sümela



Kod Code	Ürün Adı Description	Ebatlar Dimension a x b x c (mm)	Kapasite Capacity (gn)
AND.ASSC-N.01	Sümela Sıcak Servis Ünitesi Nefeslikli Sümela Hot Service Units Chafing Dish	1200x900x900/1550	1/1 Gn Chafing Dish
AND.ASSC-N.02	Sümela Sıcak Servis Ünitesi Nefeslikli Sümela Hot Service Units Chafing Dish	1800x900x900/1550	2x(1/1 Gn) Chafing Dish
AND.ASSC-N.03	Sümela Sıcak Servis Ünitesi Nefeslikli Sümela Hot Service Units Chafing Dish	2600x900x900/1550	3x(1/1 Gn) Chafing Dish

TEKNİK ÖZELLİKLER

- Granit üst tabla.
- Dekoratif ahşap kaplama.
- Paslanmaz alt baza.
- Bombe camlı nefeslik.
- Led aydınlatma.
- Tabak rafı.

TECHNICAL SPECIFICATIONS

- Granite top table.
- Wooden Decoration.
- Stainless steel frame.
- With sneeze guard.
- Led lighting.
- Plate shelve.

Sümela



Kod Code	Ürün Adı Description	Ebatlar Dimension a x b x c (mm)	Kapasite Capacity (gn)
AND.ASSC.01	Sümela Sıcak Servis Ünitesi Reşolu Sümela Hot Service Units Chafing Dish	1200x900x900	1x1/1 Gn Chafing Dish
AND.ASSC.02	Sümela Sıcak Servis Ünitesi Reşolu Sümela Hot Service Units Chafing Dish	1800x900x900	2x1/1 Gn Chafing Dish
AND.ASSC.03	Sümela Sıcak Servis Ünitesi Reşolu Sümela Hot Service Units Chafing Dish	2600x900x900	3x1/1 Gn Chafing Dish

TEKNİK ÖZELLİKLER

- Granit üst tabla.
- Dekoratif ahşap kaplama.
- Paslanmaz alt baza.
- Tabak rafı.

TECHNICAL SPECIFICATIONS

- Granite top table.
- Wooden Decoration.
- Stainless steel frame.
- Plate shelve.

Sümela



Kod Code	Ürün Adı Description	Ebatlar Dimension a x b x c (mm)	Kapasite Capacity (gn)
AND.ACSU.01	Sümela Çorba Servis Ünitesi Sümela Soup Service Units	1400x900x900	1 Çorbalık Soup Dispenser
AND.ACSU.02	Sümela Çorba Servis Ünitesi Sümela Soup Service Units	2000x900x900	2 Çorbalık Soup Dispenser
AND.ACSU.03	Sümela Çorba Servis Ünitesi Sümela Soup Service Units	2400x900x900	3 Çorbalık Soup Dispenser

TEKNİK ÖZELLİKLER

- Granit üst tabla.
- Dekoratif ahşap kaplama.
- Paslanmaz alt baza.
- Tabak rafı.

TECHNICAL SPECIFICATIONS

- Granite top table.
- Wooden Decoration.
- Stainless steel frame.
- Plate shelve.

Sümela



Kod Code	Ürün Adı Description	Ebatlar Dimension a x b x c (mm)
AND.AESU.01	Sümela Ekmek Servis Ünitesi Sümela Bread Service Units	1000x900x900
AND.AESU.02	Sümela Ekmek Servis Ünitesi Sümela Bread Service Units	1200x900x900
AND.AESU.03	Sümela Ekmek Servis Ünitesi Sümela Bread Service Units	1400x900x900
AND.AESU.04	Sümela Ekmek Servis Ünitesi Sümela Bread Service Units	1600x900x900
AND.AESU.05	Sümela Ekmek Servis Ünitesi Sümela Bread Service Units	1800x900x900
AND.AESU.06	Sümela Ekmek Servis Ünitesi Sümela Bread Service Units	2000x900x900
AND.AESU.07	Sümela Ekmek Servis Ünitesi Sümela Bread Service Units	2200x900x900
AND.AESU.08	Sümela Ekmek Servis Ünitesi Sümela Bread Service Units	2400x900x900

TEKNİK ÖZELLİKLER

- Granit üst tabla.
- Dekoratif ahşap kaplama.
- Paslanmaz alt baza.
- Tabak rafı.

TECHNICAL SPECIFICATIONS

- Granite top table.
- Wooden Decoration.
- Stainless steel frame.
- Plate shelf.

Sümela



Kod Code	Ürün Adı Description	Ebatlar Dimension
		a x b x c (mm)
AND.AUT.01	Sümela U Form Tabaklık Sümela Plate Dispenser Unit	1100x900x900

TEKNİK ÖZELLİKLER

- Granit üst tabla.
- Dekoratif ahşap kaplama.
- Paslanmaz alt baza.

TECHNICAL SPECIFICATIONS

- Granite top table.
- Wooden Decoration.
- Stainless steel frame.



Sümela



Kod Code	Ürün Adı Description	Ebatlar Dimension a x b x c (mm)	Kapasite Capacity
AND.ATD.01	Sümela Tabak Dispenseri Sümela Plate Dispenser	1100x900x900	2 Tabaklı / Plate Isıtmalı / Heated
AND.ATD.02	Sümela Tabak Dispenseri Sümela Plate Dispenser	1100x900x900	2 Tabaklı / Plate Nötr / Neutral

TEKNİK ÖZELLİKLER

- Granit üst tabla.
- Dekoratif ahşap kaplama.
- Paslanmaz alt baza.

TECHNICAL SPECIFICATIONS

- Granite top table.
- Wooden Decoration.
- Stainless steel frame.

Raflar - Nötr Üniteler

Shelves - Neutral Units



andora

andora

RAFLAR - NÖTR ÜNİTELER

- Polipropilen Raflar (Delikli)
- Polipropilen Raflar (Delikli Tablalı)
- Polipropilen Raflar (Düz)
- Polipropilen Raflar (Düz Tablalı)
- Tel Raflar
- Tel Raflar 4 Katlı (1800 mm)
- Düz Raflar
- Düz Raflar 4 Katlı (1800 mm)
- Delikli Raflar
- Delikli Raflar 4 Katlı (1800 mm)
- Tel Izgaralar - Davlumbaz Filtreleri - Boru Ayaklar
- Yer Filtreleri (Alttan - Yandan Çıkışlı)
- Çalışma Tezgahları**
- Çalışma Tezgahları (Demonte)
- Çalışma Tezgahları Alt Raflı (Demonte)
- Çalışma Tezgahları Alt - Ara Raflı (Demonte)
- Çalışma Tezgahları Polietilen (Demonte)
- Çalışma Tezgahları Alt Raflı Polietilen (Demonte)
- Dolaplı Çalışma Tezgahları (Kaynaklı)
- Köşe Tezgahları
- Köşe Tezgahları - Et Kütükleri
- Blok Çekmece Üniteleri

SHELVES - NEUTRAL UNITS

- Polipropilen Shelves (Perforated)
- Polipropilen Shelves (Perforated)
- Polipropilen Shelves (Smooth)
- Polipropilen Shelves (Smooth)
- Wire Shelves
- Wire Shelves with 4 Floor (1800 mm)
- Smooth Shelves
- Smooth Shelves with 4 Floor (1800 mm)
- Perforated Shelves
- Perforated Shelves with 4 Floor (1800 mm)
- Wire Grids - Hood Filters - Foots
- Floor Filters (Bottom - Side Outlet)
- Work Tables**
- Work Tables (Demounted)
- Work Tables with Bottom Shelf (Demounted)
- Work Tables with Bottom - Intermediate Shelf (Demounted)
- Work Tables Polyethylen (Demounted)
- Work Tables with Bottom Shelf Polyethylen (Demounted)
- Work Tables Cabinets (Welded)
- Corner Tables
- Corner Tables - Meat Blocks
- Drawers Units

andora

RAFLAR - NÖTR ÜNİTELER

Evyeli Tezgahlar

- 1 Evyeli Tezgahlar 600 / 700 (Demonte)
- 1 Evyeli Tezgahlar 700 (Demonte)
- 1 Evyeli Tezgahlar 600 / 700 (Demonte)
- 2 Evyeli Tezgahlar 600 / 700 (Demonte)
- 2 Evyeli Tezgahlar 700 (Demonte)
- 2 Evyeli Tezgahlar 600 / 700 (Demonte)
- 3 Evyeli Tezgahlar 600 - 700 (Demonte)

Duvar Rafları

- Duvar Rafları Ayarlanabilir (Demonte)
- Duvar Rafları Perfore Ayarlanabilir (Demonte)

Duvar Dolapları

- Sebze Yıkama Tezgahları / Duvar Dolapları 30/40'lık Seri (Sürgü Kapaklı)

Davlumbazlar

- Davlumbazlar Duvar Tip Filtreli (400 Seri)
- Davlumbazlar Duvar Tip Filtreli (500 Seri)
- Kutu Davlumbazlar Duvar Tip Filtreli (400 Seri)
- Kutu Davlumbazlar Duvar Tip Filtreli (500 Seri)
- Davlumbazlar Orta Tip Filtreli

SHELVES - NEUTRAL UNITS

Table with Sink

- Work Tables with 1 Sink 600 / 700 (Demounted)
- Work Tables with 1 Sink 700 (Demounted)
- Work Tables with 1 Sink 600 / 700 (Demounted)
- Work Tables with 2 Sink 600 / 700 (Demounted)
- Work Tables with 2 Sink 700 (Demounted)
- Work Tables with 2 Sink 600 / 700 (Demounted)
- Work Tables with 3 Sink 600 - 700 (Demounted)

Wall Shelves

- Wall Shelves Adjustable (Demounted)
- Wall Shelves Perforated Adjustable (Demounted)

Wall Cupboards

- Vegetable Washing Units / Wall Cabinets 30/40' s Serie (Sliding Doors)

Hoods

- Wall Type Hoods with Filters (400 Series)
- Wall Type Hoods with Filters (500 Series)
- Wall Type Box Hoods with Filters (400 Series)
- Wall Type Box Hoods with Filters (500 Series)
- Central Type Hoods with Filters

Raflar Shelves

Polipropilen Raflar (Delikli) Polipropilen Shelves (Perforated)

andora

Her kat için 250 kg taşıma kapasitesi
250 Kg capacity for each shelf



Delikli Raf Tablaları En 400 mm Perforated Shelf Plates Width 400 mm

Kod Code	Ebatlar Dimension
	a x b x c (mm)
AND.A4097-D	970x400
AND.A40127-D	1270x400
AND.A40157-D	1570x400

Delikli Raf Tablaları En 500 mm Perforated Shelf Plates Width 500 mm

Kod Code	Ebatlar Dimension
	a x b x c (mm)
AND.A5097-D	970x500
AND.A50127-D	1270x500
AND.A50157-D	1570x500

Delikli Raf Tablaları En 600 mm Perforated Shelf Plates Width 600 mm

Kod Code	Ebatlar Dimension
	a x b x c (mm)
AND.A6097-D	970x600
AND.A60127-D	1270x600
AND.A60157-D	1570x600



Sabit Alüminyum Raf Ayakları Fixed Aluminium Shelf Feet

Kod Code	Ebatlar Dimension
	a x b x c (mm)
AND.A1800-A-40	1800
AND.A1800-A-50	1800
AND.A1800-A-60	1800

Tekerlekli Alüminyum Raf Ayakları Wheeled Aluminium Shelf Feet

Kod Code	Ebatlar Dimension
	a x b x c (mm)
AND.A1800-A-H-40	1800
AND.A1800-A-H-50	1800
AND.A1800-A-H-60	1800

Köşe Aparatı Corner Part

Kod Code
AND.A1800.KS

TEKNİK ÖZELLİKLER

- Hijyenik polipropilen tabla.
- Alüminyum ayak.
- Sökülebilir, yıkanılabilir tabla özelliği.
- Nemli, kuru, soğuk ve sıcak hava koşullarına dayanıklılık.

TECHNICAL SPECIFICATIONS

- Hygienic polypropylene shelf.
- Aluminum feet.
- Removable, washable shelves.
- High endurance in wet, dry, cold and hot environments.

Her kat için 250 kg taşıma kapasitesi
250 Kg capacity for each shelf



Polipropilen Raflar - Delikli Tablalı En 400 mm
Polipropilen Shelves - Perforated Width 400 mm

Kod Code	Ebatlar Dimension
	a x b x c (mm)
AND.A4097-18-D	970x400x1800
AND.A40127-18-D	1270x400x1800
AND.A40157-18-D	1570x400x1800
AND.A40190-18-D	1905x400x1800
AND.A40220-18-D	2205x400x1800
AND.A40250-18-D	2505x400x1800
AND.A40280-18-D	2805x400x1800
AND.A40310-18-D	3105x400x1800
AND.A40344-18-D	3440x400x1800
AND.A40374-18-D	3740x400x1800
AND.A40404-18-D	4040x400x1800
AND.A40434-18-D	4340x400x1800
AND.A40467-18-D	4675x400x1800
AND.A40497-18-D	4975x400x1800
AND.A40527-18-D	5275x400x1800
AND.A40557-18-D	5575x400x1800
AND.A40587-18-D	5875x400x1800
AND.A40617-18-D	6175x400x1800

Polipropilen Raflar - Delikli Tablalı En 500 mm
Polipropilen Shelves - Perforated Width 500 mm

Kod Code	Ebatlar Dimension
	a x b x c (mm)
AND.A5097-18-D	970x500x1800
AND.A50127-18-D	1270x500x1800
AND.A50157-18-D	1570x500x1800
AND.A50190-18-D	1905x500x1800
AND.A50220-18-D	2205x500x1800
AND.A50250-18-D	2505x500x1800
AND.A50280-18-D	2805x500x1800
AND.A50310-18-D	3105x500x1800
AND.A50344-18-D	3440x500x1800
AND.A50374-18-D	3740x500x1800
AND.A50404-18-D	4040x500x1800
AND.A50434-18-D	4340x500x1800
AND.A50467-18-D	4675x500x1800
AND.A50497-18-D	4975x500x1800
AND.A50527-18-D	5275x500x1800
AND.A50557-18-D	5575x500x1800
AND.A50587-18-D	5875x500x1800
AND.A50617-18-D	6175x500x1800

Polipropilen Raflar - Delikli Tablalı En 600 mm
Polipropilen Shelves - Perforated Width 600 mm

Kod Code	Ebatlar Dimension
	a x b x c (mm)
AND.A6097-18-D	970x600x1800
AND.A60127-18-D	1270x600x1800
AND.A60157-18-D	1570x600x1800
AND.A60190-18-D	1905x600x1800
AND.A60220-18-D	2205x600x1800
AND.A60250-18-D	2505x600x1800
AND.A60280-18-D	2805x600x1800
AND.A60310-18-D	3105x600x1800
AND.A60344-18-D	3440x600x1800
AND.A60374-18-D	3740x600x1800
AND.A60404-18-D	4040x600x1800
AND.A60434-18-D	4340x600x1800
AND.A60467-18-D	4675x600x1800
AND.A60497-18-D	4975x600x1800
AND.A60527-18-D	5275x600x1800
AND.A60557-18-D	5575x600x1800
AND.A60587-18-D	5875x600x1800
AND.A60617-18-D	6175x600x1800

TEKNİK ÖZELLİKLER

- Hijyenik polipropilen tabla.
- Alüminyum ayak.
- Sökülebilir, yıkanılabilir tabla özelliği.
- Nemli, kuru, soğuk ve sıcak hava koşullarına dayanıklılık.

TECHNICAL SPECIFICATIONS

- Hygienic polypropene shelfe.
- Aluminum feet.
- Removable, washable shelves.
- High endurance in wet, dry, cold and hot environments.

Raflar Shelves

Polipropilen Raflar (Düz) Polipropilen Shelves (Smooth)

andora

Her kat için 250 kg taşıma kapasitesi
250 Kg capacity for each shelf



Düz Raf Tablaları En 400 mm Smooth Shelf Plates Width 400 mm

Kod Code	Ebatlar Dimension
	a x b x c (mm)
AND.A4097	970x400
AND.A40127	1270x400
AND.A40157	1570x400

Düz Raf Tablaları En 500 mm Smooth Shelf Plates Width 500 mm

Kod Code	Ebatlar Dimension
	a x b x c (mm)
AND.A5097	970x500
AND.A50127	1270x500
AND.A50157	1570x500

Düz Raf Tablaları En 600 mm Smooth Shelf Plates Width 600 mm

Kod Code	Ebatlar Dimension
	a x b x c (mm)
AND.A6097	970x600
AND.A60127	1270x600
AND.A60157	1570x600



Sabit Alüminyum Raf Ayakları Fixed Aluminium Shelf Feeds

Kod Code	Ebatlar Dimension
	a x b x c (mm)
AND.A1800-A-40	1800
AND.A1800-A-50	1800
AND.A1800-A-60	1800

Tekerlekli Alüminyum Raf Ayakları Wheeled Aluminium Shelf Feeds

Kod Code	Ebatlar Dimension
	a x b x c (mm)
AND.A1800-A-H-40	1800
AND.A1800-A-H-50	1800
AND.A1800-A-H-60	1800

Köşe Aparatı Corner Part

Kod Code
AND.A1800.KS

TEKNİK ÖZELLİKLER

- Hijyenik polipropilen tabla.
- Alüminyum ayak.
- Sökülebilir, yıkanılabilir tabla özelliği.
- Nemli, kuru, soğuk ve sıcak hava koşullarına dayanıklılık.

TECHNICAL SPECIFICATIONS

- Hygienic polypropylene shelf.
- Aluminum feet.
- Removable, washable shelves.
- High endurance in wet, dry, cold and hot environments.

Her kat için 250 kg taşıma kapasitesi
250 Kg capacity for each shelf



Polipropilen Raflar Düz Tablalı En 400 mm
Polipropilen Shelves Smooth Width 400 mm

Kod Code	Ebatlar Dimension
	a x b x c (mm)
AND.A4097-18	970x400x1800
AND.A40127-18	1270x400x1800
AND.A40157-18	1570x400x1800
AND.A40190-18	1905x400x1800
AND.A40220-18	2205x400x1800
AND.A40250-18	2505x400x1800
AND.A40280-18	2805x400x1800
AND.A40310-18	3105x400x1800
AND.A40344-18	3440x400x1800
AND.A40374-18	3740x400x1800
AND.A40404-18	4040x400x1800
AND.A40434-18	4340x400x1800
AND.A40467-18	4675x400x1800
AND.A40497-18	4975x400x1800
AND.A40527-18	5275x400x1800
AND.A40557-18	5575x400x1800
AND.A40587-18	5875x400x1800
AND.A40617-18	6175x400x1800

Polipropilen Raflar Düz Tablalı En 500 mm
Polipropilen Shelves Smooth Width 500 mm

Kod Code	Ebatlar Dimension
	a x b x c (mm)
AND.A5097-18	970x500x1800
AND.A50127-18	1270x500x1800
AND.A50157-18	1570x500x1800
AND.A50190-18	1905x500x1800
AND.A50220-18	2205x500x1800
AND.A50250-18	2505x500x1800
AND.A50280-18	2805x500x1800
AND.A50310-18	3105x500x1800
AND.A50344-18	3440x500x1800
AND.A50374-18	3740x500x1800
AND.A50404-18	4040x500x1800
AND.A50434-18	4340x500x1800
AND.A50467-18	4675x500x1800
AND.A50497-18	4975x500x1800
AND.A50527-18	5275x500x1800
AND.A50557-18	5575x500x1800
AND.A50587-18	5875x500x1800
AND.A50617-18	6175x500x1800

Polipropilen Raflar Düz Tablalı En 600 mm
Polipropilen Shelves Smooth Width 600 mm

Kod Code	Ebatlar Dimension
	a x b x c (mm)
AND.A6097-18	970x600x1800
AND.A60127-18	1270x600x1800
AND.A60157-18	1570x600x1800
AND.A60190-18	1905x600x1800
AND.A60220-18	2205x600x1800
AND.A60250-18	2505x600x1800
AND.A60280-18	2805x600x1800
AND.A60310-18	3105x600x1800
AND.A60344-18	3440x600x1800
AND.A60374-18	3740x600x1800
AND.A60404-18	4040x600x1800
AND.A60434-18	4340x600x1800
AND.A60467-18	4675x600x1800
AND.A60497-18	4975x600x1800
AND.A60527-18	5275x600x1800
AND.A60557-18	5575x600x1800
AND.A60587-18	5875x600x1800
AND.A60617-18	6175x600x1800

TEKNİK ÖZELLİKLER

- Hijyenik polipropilen tabla.
- Alüminyum ayak.
- Sökülebilir, yıkanılabilir tabla özelliği.
- Nemli, kuru, soğuk ve sıcak hava koşullarına dayanıklılık.

TECHNICAL SPECIFICATIONS

- Hygienic polypropylene shelfe.
- Aluminum feet.
- Removable, washable shelves.
- High endurance in wet, dry, cold and hot environments.

Her kat için 250 kg taşıma kapasitesi
250 Kg capacity for each shelf

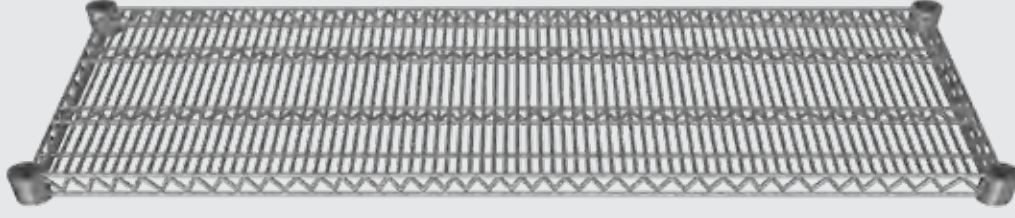

Tel Raflar En 360 mm
Wire Shelves Width 360 mm

Kod Code	Ebatlar Dimension
	a x b x c (mm)
AND.AT.3.3676	360x760
AND.AT.3.3691	360x910
AND.AT.3.36107	360x1070
AND.AT.3.36122	360x1220
AND.AT.3.36137	360x1370
AND.AT.3.36152	360x1520
AND.AT.3.36183	360x1830

INOX 304

Tel Raflar En 360 mm
Wire Shelves Width 360 mm

Kod Code	Ebatlar Dimension
	a x b x c (mm)
AND.AT.2.3676	360x760
AND.AT.2.3691	360x910
AND.AT.2.36107	360x1070
AND.A2.36122	360x1220
AND.AT.2.36137	360x1370
AND.AT.2.36152	360x1520
AND.AT.2.36183	360x1830

INOX 201

Tel Raflar En 460 mm
Wire Shelves Width 460 mm

Kod Code	Ebatlar Dimension
	a x b x c (mm)
AND.AT.3.4676	460x760
AND.AT.3.4691	460x910
AND.AT.3.46107	460x1070
AND.AT.3.46122	460x1220
AND.AT.3.46137	460x1370
AND.AT.3.46152	460x1520
AND.AT.3.46183	460x1830

INOX 304

Tel Raflar En 460 mm
Wire Shelves Width 460 mm

Kod Code	Ebatlar Dimension
	a x b x c (mm)
AND.AT.2.4676	460x760
AND.AT.2.4691	460x910
AND.AT.2.46107	460x1070
AND.AT.2.46122	460x1220
AND.AT.2.46137	460x1370
AND.AT.2.46152	460x1520
AND.AT.2.46183	460x1830

INOX 201

Raf Ayakları 1800 mm
Shelves Feet Width 1800 mm

Kod Code	Ebatlar Dimension
	a x b x c (mm)
AND.A1800-3	1800
AND.A1800-3-H	1800

INOX 304



AND.A1800-3

AND.A1800-3-H

Raf Ayakları 1800 mm
Shelves Feet Width 1800 mm

Kod Code	Ebatlar Dimension
	a x b x c (mm)
AND.A1800-2	1800
AND.A1800-2-H	1800

INOX 201

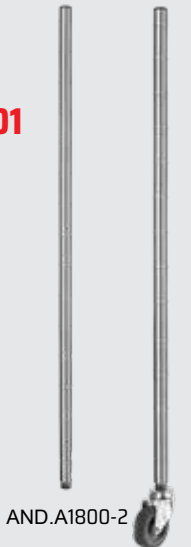

AND.A1800-2

AND.A1800-2-H

Her kat için 250 kg taşıma kapasitesi
250 Kg capacity for each shelf

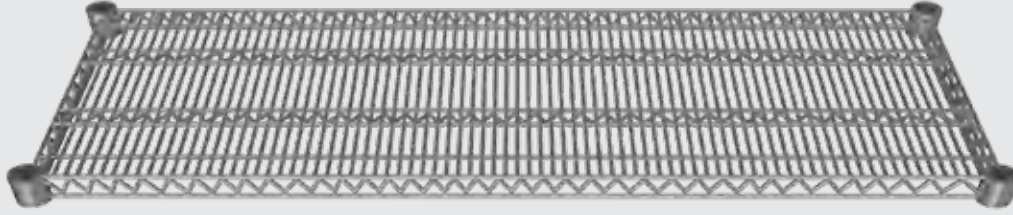

Tel Raflar En 530 mm
Wire Shelves Width 530 mm

Kod Code	Ebatlar Dimension
	a x b x c (mm)
AND.AT.3.5376	530x760
AND.AT.3.5391	530x910
AND.AT.3.53107	530x1070
AND.AT.3.53122	530x1220
AND.AT.3.53137	530x1370
AND.AT.3.53152	530x1520
AND.AT.3.53183	530x1830

INOX 304

Tel Raflar En 530 mm
Wire Shelves Width 530 mm

Kod Code	Ebatlar Dimension
	a x b x c (mm)
AND.AT.2.5376	530x760
AND.AT.2.5391	530x910
AND.AT.2.53107	530x1070
AND.AT.2.53122	530x1220
AND.AT.2.53137	530x1370
AND.AT.2.53152	530x1520
AND.AT.2.53183	530x1830

INOX 201

Tel Raflar En 610 mm
Wire Shelves Width 610 mm

Kod Code	Ebatlar Dimension
	a x b x c (mm)
AND.AT.3.6176	610x760
AND.AT.3.6191	610x910
AND.AT.3.61107	610x1070
AND.AT.3.61122	610x1220
AND.AT.3.61137	610x1370
AND.AT.3.61152	610x1520
AND.AT.3.61183	610x1830

INOX 304

Tel Raflar En 610 mm
Wire Shelves Width 610 mm

Kod Code	Ebatlar Dimension
	a x b x c (mm)
AND.AT.2.6176	610x760
AND.AT.2.6191	610x910
AND.AT.2.61107	610x1070
AND.AT.2.61122	610x1220
AND.AT.2.61137	610x1370
AND.AT.2.61152	610x1520
AND.AT.2.61183	610x1830

INOX 201

Raf Ayakları 1800 mm
Shelf Feets Width 1800 mm

Kod Code	Ebatlar Dimension
	a x b x c (mm)
AND.A1800-3	1800
AND.A1800-3-H	1800

INOX 304



AND.A1800-3

AND.A1800-3-H

Raf Ayakları 1800 mm
Shelf Feets Width 1800 mm

Kod Code	Ebatlar Dimension
	a x b x c (mm)
AND.A1800-2	1800
AND.A1800-2-H	1800

INOX 201

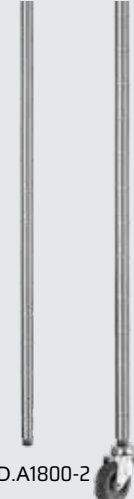

AND.A1800-2

AND.A1800-2-H

Raflar Shelves

Tel Raflar 4 Katlı (1800 mm) Wire Shelves with 4 Floor (1800 mm)

andora

Her kat için 250 kg taşıma kapasitesi
250 Kg capacity for each shelf



4 Katlı Tel Raflar En 360 mm with 4 Floor Wire Shelves Width 360 mm

Kod Code	Ebatlar Dimension
	a x b x c (mm)
AND.AT.3.3676-18-4	360x760x1800
AND.AT.3.3691-18-4	360x910x1800
AND.AT.3.36107-18-4	360x1070x1800
AND.AT.3.36122-18-4	360x1220x1800
AND.AT.3.36137-18-4	360x1370x1800
AND.AT.3.36152-18-4	360x1520x1800
AND.AT.3.36183-18-4	360x1830x1800

INOX 304

4 Katlı Tel Raflar En 360 mm with 4 Floor Wire Shelves Width 360 mm

Kod Code	Ebatlar Dimension
	a x b x c (mm)
AND.AT.2.3676-18-4	360x760x1800
AND.AT.2.3691-18-4	360x910x1800
AND.AT.2.36107-18-4	360x1070x1800
AND.AT.2.36122-18-4	360x1220x1800
AND.AT.2.36137-18-4	360x1370x1800
AND.AT.2.36152-18-4	360x1520x1800
AND.AT.2.36183-18-4	360x1830x1800

INOX 201

4 Katlı Tel Raflar En 460 mm with 4 Floor Wire Shelves Width 460 mm

Kod Code	Ebatlar Dimension
	a x b x c (mm)
AND.AT.3.4676-18-4	460x760x1800
AND.AT.3.4691-18-4	460x910x1800
AND.AT.3.46107-18-4	460x1070x1800
AND.AT.3.46122-18-4	460x1220x1800
AND.AT.3.46137-18-4	460x1370x1800
AND.AT.3.46152-18-4	460x1520x1800
AND.AT.3.46183-18-4	460x1830x1800

INOX 304

4 Katlı Tel Raflar En 460 mm with 4 Floor Wire Shelves Width 460 mm

Kod Code	Ebatlar Dimension
	a x b x c (mm)
AND.AT.2.4676-18-4	460x760x1800
AND.AT.2.4691-18-4	460x910x1800
AND.AT.2.46107-18-4	460x1070x1800
AND.AT.2.46122-18-4	460x1220x1800
AND.AT.2.46137-18-4	460x1370x1800
AND.AT.2.46152-18-4	460x1520x1800
AND.AT.2.46183-18-4	460x1830x1800

INOX 201

Her kat için 250 kg taşıma kapasitesi
250 Kg capacity for each shelf



4 Katlı Tel Raflar En 530 mm
with 4 Floor Wire Shelves Width 530 mm

Kod Code	Ebatlar Dimension
	a x b x c (mm)
AND.AT.3.5376-18-4	530x760x1800
AND.AT.3.5391-18-4	530x910x1800
AND.AT.3.53107-18-4	530x1070x1800
AND.AT.3.53122-18-4	530x1220x1800
AND.AT.3.53137-18-4	530x1370x1800
AND.AT.3.53152-18-4	530x1520x1800
AND.AT.3.53183-18-4	530x1830x1800

4 Katlı Tel Raflar En 610 mm
with 4 Floor Wire Shelves Width 610 mm

Kod Code	Ebatlar Dimension
	a x b x c (mm)
AND.AT.3.6176-18-4	610x760x1800
AND.A.T.3.6191-18-4	610x910x1800
AND.AT.3.61107-18-4	610x1070x1800
AND.AT.3.61122-18-4	610x1220x1800
AND.AT.3.61137-18-4	610x1370x1800
AND.AT.3.61152-18-4	610x1520x1800
AND.AT.3.61183-18-4	610x1830x1800

INOX 304

4 Katlı Tel Raflar En 530 mm
with 4 Floor Wire Shelves Width 530 mm

Kod Code	Ebatlar Dimension
	a x b x c (mm)
AND.AT.2.5376-18-4	530x760x1800
AND.AT.2.5391-18-4	530x910x1800
AND.AT.2.53107-18-4	530x1070x1800
AND.AT.2.53122-18-4	530x1220x1800
AND.AT.2.53137-18-4	530x1370x1800
AND.AT.2.53152-18-4	530x1520x1800
AND.AT.2.53183-18-4	530x1830x1800

INOX 201

INOX 304

4 Katlı Tel Raflar En 610 mm
with 4 Floor Wire Shelves Width 610 mm

Kod Code	Ebatlar Dimension
	a x b x c (mm)
AND.AT.2.6176-18-4	610x760x1800
AND.AT.2.6191-18-4	610x910x1800
AND.AT.2.61107-18-4	610x1070x1800
AND.AT.2.61122-18-4	610x1220x1800
AND.AT.2.61137-18-4	610x1370x1800
AND.AT.2.61152-18-4	610x1520x1800
AND.AT.2.61183-18-4	610x1830x1800

INOX 201

Raflar Shelves

Düz Raflar Smooth Shelves

andora

Her kat için 250 kg taşıma kapasitesi
250 Kg capacity for each shelf



Düz Raflar En 360 mm Smooth Shelves Width 360 mm

INOX 304

Kod Code	Ebatlar Dimension
	a x b x c (mm)
AND.AD.3.3676	360x760
AND.AD.3.3691	360x910
AND.AD.3.36107	360x1070
AND.AD.3.36122	360x1220
AND.AD.3.36137	360x1370
AND.AD.3.36152	360x1520
AND.AD.3.36183	360x1830

Düz Raflar En 360 mm Smooth Shelves Width 360 mm

INOX 201

Kod Code	Ebatlar Dimension
	a x b x c (mm)
AND.AD.2.3676	360x760
AND.AD.2.3691	360x910
AND.AD.2.36107	360x1070
AND.AD.2.36122	360x1220
AND.AD.2.36137	360x1370
AND.AD.2.36152	360x1520
AND.AD.2.36183	360x1830

Düz Raflar En 460 mm Smooth Shelves Width 460 mm

INOX 304

Kod Code	Ebatlar Dimension
	a x b x c (mm)
AND.AD.3.4676	460x760
AND.AD.3.4691	460x910
AND.AD.3.46107	460x1070
AND.AD.3.46122	460x1220
AND.AD.3.46137	460x1370
AND.AD.3.46152	460x1520
AND.AD.3.46183	460x1830

Düz Raflar En 460 mm Smooth Shelves Width 460 mm

INOX 201

Kod Code	Ebatlar Dimension
	a x b x c (mm)
AND.AD.2.4676	460x760
AND.AD.2.4691	460x910
AND.AD.2.46107	460x1070
AND.AD.2.46122	460x1220
AND.AD.2.46137	460x1370
AND.AD.2.46152	460x1520
AND.AD.2.46183	460x1830

Raf Ayakları 1800 mm Shelf Feet Width 1800 mm

INOX 304

Kod Code	Ebatlar Dimension
	a x b x c (mm)
AND.A1800-3	1800
AND.A1800-3-H	1800

Raf Ayakları 1800 mm Shelf Feet Width 1800 mm

INOX 201

Kod Code	Ebatlar Dimension
	a x b x c (mm)
AND.A1800-2	1800
AND.A1800-2-H	1800



AND.A1800-3

AND.A1800-3-H

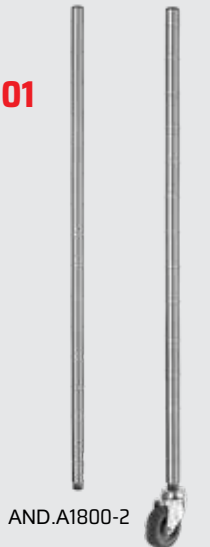

AND.A1800-2

AND.A1800-2-H

Her kat için 250 kg taşıma kapasitesi
250 Kg capacity for each shelf



Düz Raflar En 530 mm
Smooth Shelves Width 530 mm

Kod Code	Ebatlar Dimension
	a x b x c (mm)
AND.AD.3.5376	530x760
AND.AD.3.5391	530x910
AND.AD.3.53107	530x1070
AND.AD.3.53122	530x1220
AND.AD.3.53137	530x1370
AND.AD.3.53152	530x1520
AND.AD.3.53183	530x1830

INOX 304

Düz Raflar En 530 mm
Smooth Shelves Width 530 mm

Kod Code	Ebatlar Dimension
	a x b x c (mm)
AND.AD.2.5376	530x760
AND.AD.2.5391	530x910
AND.AD.2.53107	530x1070
AND.AD.2.53122	530x1220
AND.AD.2.53137	530x1370
AND.AD.2.53152	530x1520
AND.AD.2.53183	530x1830

INOX 201

Düz Raflar En 610 mm
Smooth Shelves Width 610 mm

Kod Code	Ebatlar Dimension
	a x b x c (mm)
AND.AD.3.6176	610x760
AND.AD.3.6191	610x910
AND.AD.3.61107	610x1070
AND.AD.3.61122	610x1220
AND.AD.3.61137	610x1370
AND.AD.3.61152	610x1520
AND.AD.3.61183	610x1830

INOX 304

Düz Raflar En 610 mm
Smooth Shelves Width 610 mm

Kod Code	Ebatlar Dimension
	a x b x c (mm)
AND.AD.2.6176	610x760
AND.AD.2.6191	610x910
AND.AD.2.61107	610x1070
AND.AD.2.61122	610x1220
AND.AD.2.61137	610x1370
AND.AD.2.61152	610x1520
AND.AD.2.61183	610x1830

INOX 201

Raf Ayakları 1800 mm
Shelf Feet Width 1800 mm

Kod Code	Ebatlar Dimension
	a x b x c (mm)
AND.A1800-3	1800
AND.A1800-3-H	1800

INOX 304

AND.A1800-3

AND.A1800-3-H

Raf Ayakları 1800 mm
Shelf Feet Width 1800 mm

Kod Code	Ebatlar Dimension
	a x b x c (mm)
AND.A.1800-2	1800
AND.A1800-2-H	1800

INOX 201

AND.A1800-2

AND.A1800-2-H

Raflar Shelves

Düz Raflar 4 Katlı (1800 mm) Smooth Shelves with 4 Floor (1800 mm)

andora

Her kat için 250 kg taşıma kapasitesi
250 Kg capacity for each shelf



4 Katlı Düz Raflar En 360 mm with 4 Floor Smooth Shelves Width 360 mm

INOX 304

4 Katlı Düz Raflar En 360 mm with 4 Floor Smooth Shelves Width 360 mm

INOX 201

Kod Code	Ebatlar Dimension
	a x b x c (mm)
AND.AD.3.3676-18-4	360x760x1800
AND.AD.3.3691-18-4	360x910x1800
AND.AD.3.36107-18-4	360x1070x1800
AND.AD.3.36122-18-4	360x1220x1800
AND.AD.3.36137-18-4	360x1370x1800
AND.AD.3.36152-18-4	360x1520x1800
AND.AD.3.36183-18-4	360x1830x1800

Kod Code	Ebatlar Dimension
	a x b x c (mm)
AND.AD.2.3676-18-4	360x760x1800
AND.AD.2.3691-18-4	360x910x1800
AND.AD.2.36107-18-4	360x1070x1800
AND.AD.2.36122-18-4	360x1220x1800
AND.AD.2.36137-18-4	360x1370x1800
AND.AD.2.36152-18-4	360x1520x1800
AND.AD.2.36183-18-4	360x1830x1800

4 Katlı Düz Raflar En 460 mm with 4 Floor Smooth Shelves Width 460 mm

INOX 304

4 Katlı Düz Raflar En 460 mm with 4 Floor Smooth Shelves Width 460 mm

INOX 201

Kod Code	Ebatlar Dimension
	a x b x c (mm)
AND.AD.3.4676-18-4	460x760x1800
AND.AD.3.4691-18-4	460x910x1800
AND.AD.3.46107-18-4	460x1070x1800
AND.AD.3.46122-18-4	460x1220x1800
AND.AD.3.46137-18-4	460x1370x1800
AND.AD.3.46152-18-4	460x1520x1800
AND.AD.3.46183-18-4	460x1830x1800

Kod Code	Ebatlar Dimension
	a x b x c (mm)
AND.AD.2.4676-18-4	460x760x1800
AND.AD.2.4691-18-4	460x910x1800
AND.AD.2.46107-18-4	460x1070x1800
AND.AD.2.46122-18-4	460x1220x1800
AND.AD.2.46137-18-4	460x1370x1800
AND.AD.2.46152-18-4	460x1520x1800
AND.AD.2.46183-18-4	460x1830x1800

Her kat için 250 kg taşıma kapasitesi
250 Kg capacity for each shelf



4 Katlı Düz Raflar En 530 mm
with 4 Floor Smooth Shelves Width 530 mm

Kod Code	Ebatlar Dimension
	a x b x c (mm)
AND.AD.3.5376-18-4	530x760x1800
AND.AD.3.5391-18-4	530x910x1800
AND.AD.3.53107-18-4	530x1070x1800
AND.AD.3.53122-18-4	530x1220x1800
AND.AD.3.53137-18-4	530x1370x1800
AND.AD.3.53152-18-4	530x1520x1800
AND.AD.3.53183-18-4	530x1830x1800

4 Katlı Düz Raflar En 610 mm
with 4 Floor Smooth Shelves Width 610 mm

Kod Code	Ebatlar Dimension
	a x b x c (mm)
AND.AD.3.6176-18-4	610x760x1800
AND.AD.3.6191-18-4	610x910x1800
AND.AD.3.61107-18-4	610x1070x1800
AND.AD.3.61122-18-4	610x1220x1800
AND.AD.3.61137-18-4	610x1370x1800
AND.AD.3.61152-18-4	610x1520x1800
AND.AD.3.61183-18-4	610x1830x1800

INOX 304

4 Katlı Düz Raflar En 530 mm
with 4 Floor Smooth Shelves Width 530 mm

Kod Code	Ebatlar Dimension
	a x b x c (mm)
AND.AD.2.5376-18-4	530x760x1800
AND.AD.2.5391-18-4	530x910x1800
AND.AD.2.53107-18-4	530x1070x1800
AND.AD.2.53122-18-4	530x1220x1800
AND.AD.2.53137-18-4	530x1370x1800
AND.AD.2.53152-18-4	530x1520x1800
AND.AD.2.53183-18-4	530x1830x1800

INOX 201

INOX 304

4 Katlı Düz Raflar En 610 mm
with 4 Floor Smooth Shelves Width 610 mm

Kod Code	Ebatlar Dimension
	a x b x c (mm)
AND.AD.2.6176-18-4	610x760x1800
AND.AD.2.6191-18-4	610x910x1800
AND.AD.2.61107-18-4	610x1070x1800
AND.AD.2.61122-18-4	610x1220x1800
AND.AD.2.61137-18-4	610x1370x1800
AND.AD.2.61152-18-4	610x1520x1800
AND.AD.2.61183-18-4	610x1830x1800

INOX 201

Her kat için 250 kg taşıma kapasitesi
250 Kg capacity for each shelf



Delikli Raflar En 360 mm
Perforated Shelves Width 360 mm

Kod Code	Ebatlar Dimension
	a x b x c (mm)
AND.AD.3.3676-D	360x760
AND.AD.3.3691-D	360x910
AND.AD.3.36107-D	360x1070
AND.AD.3.36122-D	360x1220
AND.AD.3.36137-D	360x1370
AND.AD.3.36152-D	360x1520
AND.AD.3.36183-D	360x1830

INOX 304

Delikli Raflar En 360 mm
Perforated Shelves Width 360 mm

Kod Code	Ebatlar Dimension
	a x b x c (mm)
AND.AD.2.3676-D	360x760
AND.AD.2.3691-D	360x910
AND.AD.2.36107-D	360x1070
AND.AD.2.36122-D	360x1220
AND.AD.2.36137-D	360x1370
AND.AD.2.36152-D	360x1520
AND.AD.2.36183-D	360x1830

INOX 201

Delikli Raflar En 460 mm
Perforated Shelves Width 460 mm

Kod Code	Ebatlar Dimension
	a x b x c (mm)
AND.AD.3.4676-D	460x760
AND.AD.3.4691-D	460x910
AND.AD.3.46107-D	460x1070
AND.AD.3.46122-D	460x1220
AND.AD.3.46137-D	460x1370
AND.AD.3.46152-D	460x1520
AND.AD.3.46183-D	460x1830

INOX 304

Delikli Raflar En 460 mm
Perforated Shelves Width 460 mm

Kod Code	Ebatlar Dimension
	a x b x c (mm)
AND.AD.2.4676-D	460x760
AND.AD.2.4691-D	460x910
AND.AD.2.46107-D	460x1070
AND.AD.2.46122-D	460x1220
AND.AD.2.46137-D	460x1370
AND.AD.2.46152-D	460x1520
AND.AD.2.46183-D	460x1830

INOX 201

Raf Ayakları 1800 mm
Shelf Feet Width 1800 mm

Kod Code	Ebatlar Dimension
	a x b x c (mm)
AND.A1800-3	1800
AND.A1800-3-H	1800

INOX 304

Raf Ayakları 1800 mm
Shelf Feet Width 1800 mm

Kod Code	Ebatlar Dimension
	a x b x c (mm)
AND.A1800-2	1800
AND.A1800-2-H	1800

INOX 201



AND.A1800-3

AND.A1800-3-H

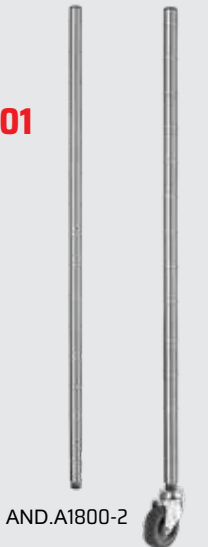

AND.A1800-2

AND.A1800-2-H

Her kat için 250 kg taşıma kapasitesi
250 Kg capacity for each shelf



Delikli Raflar En 530 mm
Perforated Shelves Width 530 mm

Kod Code	Ebatlar Dimension
	a x b x c (mm)
AND.AD.3.5376-D	530x760
AND.AD.3.5391-D	530x910
AND.AD.3.53107-D	530x1070
AND.AD.3.53122-D	530x1220
AND.AD.3.53137-D	530x1370
AND.AD.3.53152-D	530x1520
AND.AD.3.53183-D	530x1830

INOX 304

Delikli Raflar En 530 mm
Perforated Shelves Width 530 mm

Kod Code	Ebatlar Dimension
	a x b x c (mm)
AND.AD.2.5376-D	530x760
AND.AD.2.5391-D	530x910
AND.AD.2.53107-D	530x1070
AND.AD.2.53122-D	530x1220
AND.AD.2.53137-D	530x1370
AND.AD.2.53152-D	530x1520
AND.AD.2.53183-D	530x1830

INOX 201

Delikli Raflar En 610 mm
Perforated Shelves Width 610 mm

Kod Code	Ebatlar Dimension
	a x b x c (mm)
AND.AD.3.6176-D	610x760
AND.AD.3.6191-D	610x910
AND.AD.3.61107-D	610x1070
AND.AD.3.61122-D	610x1220
AND.AD.3.61137-D	610x1370
AND.AD.3.61152-D	610x1520
AND.AD.3.61183-D	610x1830

INOX 304

Delikli Raflar En 610 mm
Perforated Shelves Width 610 mm

Kod Code	Ebatlar Dimension
	a x b x c (mm)
AND.AD.2.6176-D	610x760
AND.AD.2.6191-D	610x910
AND.AD.2.61107-D	610x1070
AND.AD.2.61122-D	610x1220
AND.AD.2.61137-D	610x1370
AND.AD.2.61152-D	610x1520
AND.AD.2.61183-D	610x1830

INOX 201

Raf Ayakları 1800 mm
Shelf Feet Width 1800 mm

Kod Code	Ebatlar Dimension
	a x b x c (mm)
AND.A1800-3	1800
AND.A1800-3-H	1800

INOX 304



AND.A1800-3

AND.A1800-3-H

Raf Ayakları 1800 mm
Shelf Feet Width 1800 mm

Kod Code	Ebatlar Dimension
	a x b x c (mm)
AND.A1800-2	1800
AND.A1800-2-H	1800

INOX 201



AND.A1800-2

AND.A1800-2-H

Raflar Shelves

Delikli Raflar 4 Katlı (1800 mm) Perforated Shelves with 4 Floor (1800 mm)

andora

Her kat için 250 kg taşıma kapasitesi
250 Kg capacity for each shelf



4 Katlı Delikli Raflar En 360 mm with 4 Floor Perforated Shelves Width 360 mm

INOX 304

Kod Code	Ebatlar Dimension
	a x b x c (mm)
AND.AD.3.3676-18-4-D	360x760x1800
AND.AD.3.3691-18-4-D	360x910x1800
AND.AD.3.36107-18-4-D	360x1070x1800
AND.AD.3.36122-18-4-D	360x1220x1800
AND.AD.3.36137-18-4-D	360x1370x1800
AND.AD.3.36152-18-4-D	360x1520x1800
AND.AD.3.36183-18-4-D	360x1830x1800

4 Katlı Delikli Raflar En 360 mm with 4 Floor Perforated Shelves Width 360 mm

INOX 201

Kod Code	Ebatlar Dimension
	a x b x c (mm)
AND.AD.2.3676-18-4-D	360x760x1800
AND.AD.2.3691-18-4-D	360x910x1800
AND.AD.2.36107-18-4-D	360x1070x1800
AND.AD.2.36122-18-4-D	360x1220x1800
AND.AD.2.36137-18-4-D	360x1370x1800
AND.AD.2.36152-18-4-D	360x1520x1800
AND.AD.2.36183-18-4-D	360x1830x1800

4 Katlı Delikli Raflar En 460 mm with 4 Floor Perforated Shelves Width 460 mm

INOX 304

Kod Code	Ebatlar Dimension
	a x b x c (mm)
AND.AD.3.4676-18-4-D	460x760x1800
AND.AD.3.4691-18-4-D	460x910x1800
AND.AD.3.46107-18-4-D	460x1070x1800
AND.AD.3.46122-18-4-D	460x1220x1800
AND.AD.3.46137-18-4-D	460x1370x1800
AND.AD.3.46152-18-4-D	460x1520x1800
AND.AD.3.46183-18-4-D	460x1830x1800

4 Katlı Delikli Raflar En 460 mm with 4 Floor Perforated Shelves Width 460 mm

INOX 201

Kod Code	Ebatlar Dimension
	a x b x c (mm)
AND.AD.2.4676-18-4-D	460x760x1800
AND.AD.2.4691-18-4-D	460x910x1800
AND.AD.2.46107-18-4-D	460x1070x1800
AND.AD.2.46122-18-4-D	460x1220x1800
AND.AD.2.46137-18-4-D	460x1370x1800
AND.AD.2.46152-18-4-D	460x1520x1800
AND.AD.2.46183-18-4-D	460x1830x1800

Her kat için 250 kg taşıma kapasitesi
250 Kg capacity for each shelf



4 Katlı Delikli Raflar En 530 mm
with 4 Floor Perforated Shelves Width 530 mm

INOX 304

Kod Code	Ebatlar Dimension
	a x b x c (mm)
AND.AD.3.5376-18-4-D	530x760x1800
AND.AD.3.5391-18-4-D	530x910x1800
AND.AD.3.53107-18-4-D	530x1070x1800
AND.AD.3.53122-18-4-D	530x1220x1800
AND.AD.3.53137-18-4-D	530x1370x1800
AND.AD.3.53152-18-4-D	530x1520x1800
AND.AD.3.53183-18-4-D	530x1830x1800

4 Katlı Delikli Raflar En 530 mm
with 4 Floor Perforated Shelves Width 530 mm

INOX 201

Kod Code	Ebatlar Dimension
	a x b x c (mm)
AND.AD.2.5376-18-4-D	530x760x1800
AND.AD.2.5391-18-4-D	530x910x1800
AND.AD.2.53107-18-4-D	530x1070x1800
AND.AD.2.53122-18-4-D	530x1220x1800
AND.AD.2.53137-18-4-D	530x1370x1800
AND.AD.2.53152-18-4-D	530x1520x1800
AND.AD.2.53183-18-4-D	530x1830x1800

4 Katlı Delikli Raflar En 610 mm
with 4 Floor Perforated Shelves Width 610 mm

INOX 304

Kod Code	Ebatlar Dimension
	a x b x c (mm)
AND.AD.3.6176-18-4-D	610x760x1800
AND.AD.3.6191-18-4-D	610x910x1800
AND.AD.3.61107-18-4-D	610x1070x1800
AND.AD.3.61122-18-4-D	610x1220x1800
AND.AD.3.61137-18-4-D	610x1370x1800
AND.AD.3.61152-18-4-D	610x1520x1800
AND.AD.3.61183-18-4-D	610x1830x1800

4 Katlı Delikli Raflar En 610 mm
with 4 Floor Perforated Shelves Width 610 mm

INOX 201

Kod Code	Ebatlar Dimension
	a x b x c (mm)
AND.AD.2.6176-18-4-D	610x760x1800
AND.AD.2.6191-18-4-D	610x910x1800
AND.AD.2.61107-18-4-D	610x1070x1800
AND.AD.2.61122-18-4-D	610x1220x1800
AND.AD.2.61137-18-4-D	610x1370x1800
AND.AD.2.61152-18-4-D	610x1520x1800
AND.AD.2.61183-18-4-D	610x1830x1800



Tel Izgaralar
Wire Grids

INOX 304

Tel Izgaralar
Wire Grids

INOX 201

Kod Code	Ebatlar Dimension
	a x b x c (mm)
AND.A3.530325	530x325 (1/1)
AND.A3.650530	650x530 (2/1)
AND.A3.600400	600x400

Kod Code	Ebatlar Dimension
	a x b x c (mm)
AND.A2.530325	530x325 (1/1)
AND.A2.650530	650x530 (2/1)
AND.A2.600400	600x400

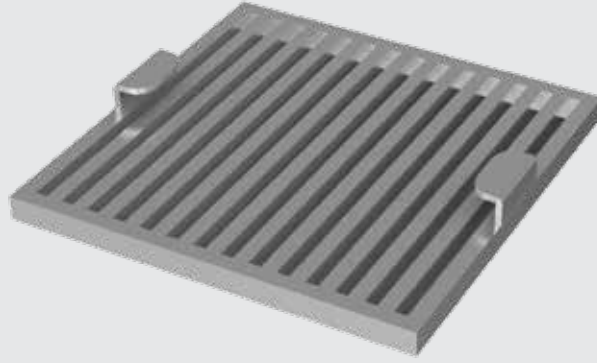

Kod Code	Ürün Adı Description	Ebatlar Dimension
		a x b x c (mm)
AND.A4.55	Davlumbaz Fitesi Filter For Hood	500x500

- 430 Kalite parlak yüzey / AISI 430 Stainless Steel Polished



Kod Code	Ürün Adı Description	Ebatlar Dimension
		a x b x c (mm)
AND.ABRA.150	Boru Ayak Foot	150



Kod Code	Ürün Adı Description	Ebatlar Dimension
		a x b x c (mm)
AND.AYF.AO.3030	Alttan Çıkışlı Ortadan Sifonlu / Bottom Outlet Center Drain	300x300x150
AND.AYF.AO.3050	Alttan Çıkışlı Ortadan Sifonlu / Bottom Outlet Center Drain	300x500x150
AND.AYF.AO.3074	Alttan Çıkışlı Ortadan Sifonlu / Bottom Outlet Center Drain	300x740x150
AND.AYF.AO.3094	Alttan Çıkışlı Ortadan Sifonlu / Bottom Outlet Center Drain	300x940x150
AND.AYF.AO.30118	Alttan Çıkışlı Ortadan Sifonlu / Bottom Outlet Center Drain	300x1180x150
AND.AYF.AO.30138	Alttan Çıkışlı Ortadan Sifonlu / Bottom Outlet Center Drain	300x1380x150
AND.AYF.AO.30161	Alttan Çıkışlı Ortadan Sifonlu / Bottom Outlet Center Drain	300x1610x150
AND.AYF.AO.30181	Alttan Çıkışlı Ortadan Sifonlu / Bottom Outlet Center Drain	300x1810x150
AND.AYF.AO.30205	Alttan Çıkışlı Ortadan Sifonlu / Bottom Outlet Center Drain	300x2050x150
AND.AYF.AO.30225	Alttan Çıkışlı Ortadan Sifonlu / Bottom Outlet Center Drain	300x2250x150
AND.AYF.AO.30249	Alttan Çıkışlı Ortadan Sifonlu / Bottom Outlet Center Drain	300x2490x150

Çıkış çapı : 74mm / Outlet Diameter : 74mm



Kod Code	Ürün Adı Description	Ebatlar Dimension
		a x b x c (mm)
AND.AYF.YO.3030	Yandan Çıkışlı Ortadan Sifonlu / Side Outlet Center Drain	300x300x150
AND.AYF.YO.3050	Yandan Çıkışlı Ortadan Sifonlu / Side Outlet Center Drain	300x500x150
AND.AYF.YO.3074	Yandan Çıkışlı Ortadan Sifonlu / Side Outlet Center Drain	300x740x150
AND.AYF.YO.3094	Yandan Çıkışlı Ortadan Sifonlu / Side Outlet Center Drain	300x940x150
AND.AYF.YO.30118	Yandan Çıkışlı Ortadan Sifonlu / Side Outlet Center Drain	300x1180x150
AND.AYF.YO.30138	Yandan Çıkışlı Ortadan Sifonlu / Side Outlet Center Drain	300x1380x150
AND.AYF.YO.30161	Yandan Çıkışlı Ortadan Sifonlu / Side Outlet Center Drain	300x1610x150
AND.AYF.YO.30181	Yandan Çıkışlı Ortadan Sifonlu / Side Outlet Center Drain	300x1810x150
AND.AYF.YO.30205	Yandan Çıkışlı Ortadan Sifonlu / Side Outlet Center Drain	300x2050x150
AND.AYF.YO.30225	Yandan Çıkışlı Ortadan Sifonlu / Side Outlet Center Drain	300x2250x150
AND.AYF.YO.30249	Yandan Çıkışlı Ortadan Sifonlu / Side Outlet Center Drain	300x2490x150

Çıkış çapı : 74mm / Outlet Diameter : 74mm

andora

ÇALIŞMA TEZGAHLARI

- Çalışma Tezgahları (Demonte)
- Çalışma Tezgahları Alt Rafı (Demonte)
- Çalışma Tezgahları Alt - Ara Rafı (Demonte)
- Çalışma Tezgahları Polietilen (Demonte)
- Çalışma Tezgahları Alt Rafı Polietilen (Demonte)
- Dolaplı Çalışma Tezgahları (Kaynaklı)
- Köşe Tezgahları
- Köşe Tezgahları - Et Kütükleri
- Blok Çekmece Üniteleri

WORK TABLES

- Work Tables (Demounted)
- Work Tables with Bottom Shelf (Demounted)
- Work Tables with Bottom - Intermediate Shelf (Demounted)
- Work Tables Polyethylen (Demounted)
- Work Tables with Bottom Shelf Polyethylen (Demounted)
- Work Tables Cabinets (Welded)
- Corner Tables
- Corner Tables - Meat Blocks
- Drawers Units



60'lık Seri / 60's Series

Kod Code	Ürün Adı Description	Ebatlar Dimension
		a x b x c (mm)
AND.AAT.6080	Çalışma Tezgahı Work Table	800x600x850
AND.AAT.60100	Çalışma Tezgahı Work Table	1000x600x850
AND.AAT.60120	Çalışma Tezgahı Work Table	1200x600x850
AND.AAT.60140	Çalışma Tezgahı Work Table	1400x600x850
AND.AAT.60160	Çalışma Tezgahı Work Table	1600x600x850
AND.AAT.60180	Çalışma Tezgahı Work Table	1800x600x850
AND.AAT.60200	Çalışma Tezgahı Work Table	2000x600x850
AND.AAT.60220	Çalışma Tezgahı Work Table	2200x600x850
AND.AAT.60240	Çalışma Tezgahı Work Table	2400x600x850

70'lık Seri / 70's Series

Kod Code	Ürün Adı Description	Ebatlar Dimension
		a x b x c (mm)
AND.AAT.7080	Çalışma Tezgahı Work Table	800x700x850
AND.AAT.70100	Çalışma Tezgahı Work Table	1000x700x850
AND.AAT.70120	Çalışma Tezgahı Work Table	1200x700x850
AND.AAT.70140	Çalışma Tezgahı Work Table	1400x700x850
AND.AAT.70160	Çalışma Tezgahı Work Table	1600x700x850
AND.AAT.70180	Çalışma Tezgahı Work Table	1800x700x850
AND.AAT.70200	Çalışma Tezgahı Work Table	2000x700x850
AND.AAT.70220	Çalışma Tezgahı Work Table	2200x700x850
AND.AAT.70240	Çalışma Tezgahı Work Table	2400x700x850

TEKNİK ÖZELLİKLER

- Tüm ürünler demonte olup, paslanmaz çelikten üretilmektedir.
- Tezgahlar standart olarak sırtlı üretilmektedir.
- Arkası sırtsız tezgahları lütfen bildiriniz.
- Tezgahlar ayarlanabilir ayaklıdır.
- Ürün siparişlerinizde sırt yönünü belirtiniz.

TECHNICAL SPECIFICATIONS

- All products are demounted and stainless steel.
- Tables are produced with back standartly.
- Please specify if you don't want back with the table.
- All tables are adjustable feet.
- Please, specify direction of back with the order

Çalışma Tezgahları Work Tables

Çalışma Tezgahları Alt Rafı (Demonte) Work Tables with Bottom Shelf (Demounted)

andora



60'lık Seri / 60's Series

Kod Code	Ürün Adı Description	Ebatlar Dimension
		a x b x c (mm)
AND.AATT.6080	Alt Rafı with Bottom Shelf	800x600x850
AND.AATT.60100	Alt Rafı with Bottom Shelf	1000x600x850
AND.AATT.60120	Alt Rafı with Bottom Shelf	1200x600x850
AND.AATT.60140	Alt Rafı with Bottom Shelf	1400x600x850
AND.AATT.60160	Alt Rafı with Bottom Shelf	1600x600x850
AND.AATT.60180	Alt Rafı with Bottom Shelf	1800x600x850
AND.AATT.60200	Alt Rafı with Bottom Shelf	2000x600x850
AND.AATT.60220	Alt Rafı with Bottom Shelf	2200x600x850
AND.AATT.60240	Alt Rafı with Bottom Shelf	2400x600x850

70'lık Seri / 70's Series

Kod Code	Ürün Adı Description	Ebatlar Dimension
		a x b x c (mm)
AND.AATT.7080	Alt Rafı with Bottom Shelf	800x700x850
AND.AATT.70100	Alt Rafı with Bottom Shelf	1000x700x850
AND.AATT.70120	Alt Rafı with Bottom Shelf	1200x700x850
AND.AATT.70140	Alt Rafı with Bottom Shelf	1400x700x850
AND.AATT.70160	Alt Rafı with Bottom Shelf	1600x700x850
AND.AATT.70180	Alt Rafı with Bottom Shelf	1800x700x850
AND.AATT.70200	Alt Rafı with Bottom Shelf	2000x700x850
AND.AATT.70220	Alt Rafı with Bottom Shelf	2200x700x850
AND.AATT.70240	Alt Rafı with Bottom Shelf	2400x700x850

TEKNİK ÖZELLİKLER

- Tüm ürünler demonte olup, paslanmaz çelikten üretilmektedir.
- Tezgahlar standart olarak sırtlı üretilmektedir.
- Arkası sırsız tezgahları lütfen bildiriniz.
- Tezgahlar ayarlanabilir ayaklıdır.
- Ürün siparişlerinizde sırt yönünü belirtiniz.

TECHNICAL SPECIFICATIONS

- All products are demounted and stainless steel.
- Tables are produced with back standarty.
- Please specify if you don't want back with the table.
- All tables are adjustable feet.
- Please, specify direction of back with the order.



60'lık Seri / 60's Series

Kod Code	Ürün Adı Description	Ebatlar Dimension
		a x b x c (mm)
AND.AATT2.6080	Alt Rafli-Ara Rafli with Bottom- Intermediate Shelf	800x600x850
AND.AATT2.60100	Alt Rafli-Ara Rafli with Bottom- Intermediate Shelf	1000x600x850
AND.AATT2.60120	Alt Rafli-Ara Rafli with Bottom- Intermediate Shelf	1200x600x850
AND.AATT2.60140	Alt Rafli-Ara Rafli with Bottom- Intermediate Shelf	1400x600x850
AND.AATT2.60160	Alt Rafli-Ara Rafli with Bottom- Intermediate Shelf	1600x600x850
AND.AATT2.60180	Alt Rafli-Ara Rafli with Bottom- Intermediate Shelf	1800x600x850
AND.AATT2.60200	Alt Rafli-Ara Rafli with Bottom- Intermediate Shelf	2000x600x850
AND.AATT2.60220	Alt Rafli-Ara Rafli with Bottom- Intermediate Shelf	2200x600x850
AND.AATT2.60240	Alt Rafli-Ara Rafli with Bottom- Intermediate Shelf	2400x600x850

70'lık Seri / 70's Series

Kod Code	Ürün Adı Description	Ebatlar Dimension
		a x b x c (mm)
AND.AATT2.7080	Alt Rafli-Ara Rafli with Bottom- Intermediate Shelf	800x700x850
AND.AATT2.70100	Alt Rafli-Ara Rafli with Bottom- Intermediate Shelf	1000x700x850
AND.AATT2.70120	Alt Rafli-Ara Rafli with Bottom- Intermediate Shelf	1200x700x850
AND.AATT2.70140	Alt Rafli-Ara Rafli with Bottom- Intermediate Shelf	1400x700x850
AND.AATT2.70160	Alt Rafli-Ara Rafli with Bottom- Intermediate Shelf	1600x700x850
AND.AATT2.70180	Alt Rafli-Ara Rafli with Bottom- Intermediate Shelf	1800x700x850
AND.AATT2.70200	Alt Rafli-Ara Rafli with Bottom- Intermediate Shelf	2000x700x850
AND.AATT2.70220	Alt Rafli-Ara Rafli with Bottom- Intermediate Shelf	2200x700x850
AND.AATT2.70240	Alt Rafli-Ara Rafli with Bottom- Intermediate Shelf	2400x700x850

TEKNİK ÖZELLİKLER

- Tüm ürünler demonte olup, paslanmaz çelikten üretilmektedir.
- Tezgahlar standart olarak sırtlı üretilmektedir.
- Arkası sırsız tezgahları lütfen bildiriniz.
- Tezgahlar ayarlanabilir ayaklıdır.
- Ürün siparişlerinizde sırt yönünü belirtiniz.

TECHNICAL SPECIFICATIONS

- All products are demounted and stainless steel.
- Tables are produced with back standantly.
- Please specify if you don't want back with the table.
- All tables are adjustable feet.
- Please, specify direction of back with the order.

Çalışma Tezgahları Work Tables

Çalışma Tezgahları Polietilen (Demonte) Work Tables Polyethylen (Demounted)

andora



60'lık Seri / 60's Series

Kod Code	Ürün Adı Description	Ebatlar Dimension
		a x b x c (mm)
AND.APT.6080	Polietilen Tezgah Polyethylen Worktable	800x600x850
AND.APT.60100	Polietilen Tezgah Polyethylen Worktable	1000x600x850
AND.APT.60120	Polietilen Tezgah Polyethylen Worktable	1200x600x850
AND.APT.60140	Polietilen Tezgah Polyethylen Worktable	1400x600x850
AND.APT.60160	Polietilen Tezgah Polyethylen Worktable	1600x600x850
AND.APT.60180	Polietilen Tezgah Polyethylen Worktable	1800x600x850
AND.APT.60200	Polietilen Tezgah Polyethylen Worktable	2000x600x850
AND.APT.60220	Polietilen Tezgah Polyethylen Worktable	2200x600x850
AND.APT.60240	Polietilen Tezgah Polyethylen Worktable	2400x600x850

70'lık Seri / 70's Series

Kod Code	Ürün Adı Description	Ebatlar Dimension
		a x b x c (mm)
AND.A.PT.7080	Polietilen Tezgah Polyethylen Worktable	800x700x850
AND.APT.70100	Polietilen Tezgah Polyethylen Worktable	1000x700x850
AND.APT.70120	Polietilen Tezgah Polyethylen Worktable	1200x700x850
AND.APT.70140	Polietilen Tezgah Polyethylen Worktable	1400x700x850
AND.APT.70160	Polietilen Tezgah Polyethylen Worktable	1600x700x850
AND.APT.70180	Polietilen Tezgah Polyethylen Worktable	1800x700x850
AND.APT.70200	Polietilen Tezgah Polyethylen Worktable	2000x700x850
AND.APT.70220	Polietilen Tezgah Polyethylen Worktable	2200x700x850
AND.APT.70240	Polietilen Tezgah Polyethylen Worktable	2400x700x850

TEKNİK ÖZELLİKLER

- Tüm ürünler demonte olup, paslanmaz çelikten üretilmektedir.
- Tezgahlar standart olarak sırtlı üretilmektedir.
- Arkası sırsız tezgahları lütfen bildiriniz.
- Tezgahlar ayarlanabilir ayaklıdır.
- Polietilen tabla standart beyaz renktir.

TECHNICAL SPECIFICATIONS

- All products are demounted and stainless steel.
- Tables are produced with back standantly.
- Please specify if you don't want back with the table.
- All tables are adjustable feet.
- Polyethylene table is standard white color.



60'lık Seri / 60's Series

Kod Code	Ürün Adı Description	Ebatlar Dimension
		a x b x c (mm)
AND.APTT.6080	Alt Rafı Polietilen with Bottom- Intermediate Shelf	800x600x850
AND.APTT.60100	Alt Rafı Polietilen with Bottom- Intermediate Shelf	1000x600x850
AND.APTT.60120	Alt Rafı Polietilen with Bottom- Intermediate Shelf	1200x600x850
AND.APTT.60140	Alt Rafı Polietilen with Bottom- Intermediate Shelf	1400x600x850
AND.APTT.60160	Alt Rafı Polietilen with Bottom- Intermediate Shelf	1600x600x850
AND.APTT.60180	Alt Rafı Polietilen with Bottom- Intermediate Shelf	1800x600x850
AND.APTT.60200	Alt Rafı Polietilen with Bottom- Intermediate Shelf	2000x600x850
AND.APTT.60220	Alt Rafı Polietilen with Bottom- Intermediate Shelf	2200x600x850
AND.APTT.60240	Alt Rafı Polietilen with Bottom- Intermediate Shelf	2400x600x850

70'lık Seri / 70's Series

Kod Code	Ürün Adı Description	Ebatlar Dimension
		a x b x c (mm)
AND.APTT.7080	Alt Rafı Polietilen with Bottom- Intermediate Shelf	800x700x850
AND.APTT.70100	Alt Rafı Polietilen with Bottom- Intermediate Shelf	1000x700x850
AND.APTT.70120	Alt Rafı Polietilen with Bottom- Intermediate Shelf	1200x700x850
AND.APTT.70140	Alt Rafı Polietilen with Bottom- Intermediate Shelf	1400x700x850
AND.APTT.70160	Alt Rafı Polietilen with Bottom- Intermediate Shelf	1600x700x850
AND.APTT.70180	Alt Rafı Polietilen with Bottom- Intermediate Shelf	1800x700x850
AND.APTT.70200	Alt Rafı Polietilen with Bottom- Intermediate Shelf	2000x700x850
AND.APTT.70220	Alt Rafı Polietilen with Bottom- Intermediate Shelf	2200x700x850
AND.APTT.70240	Alt Rafı Polietilen with Bottom- Intermediate Shelf	2400x700x850

TEKNİK ÖZELLİKLER

- Tüm ürünler demonte olup, paslanmaz çelikten üretilmektedir.
- Tezgahlar standart olarak sırtlı üretilmektedir.
- Arkası sırsız tezgahları lütfen bildiriniz.
- Tezgahlar ayarlanabilir ayaklıdır.
- Ürün siparişlerinizde sırt yönünü belirtiniz.
- Polietilen tabla standart beyaz renktir.

TECHNICAL SPECIFICATIONS

- All products are demounted and stainless steel.
- Tables are produced with back standartly.
- Please specify if you don't want back with the table.
- All tables are adjustable feet.
- Please, specify direction of back with the order.
- Polyethylene table is standard white color.



60'lık Seri / 60's Series

Kod Code	Ürün Adı Description	Ebatlar Dimension
		a x b x c (mm)
AND.ADLP.60120	Dolaplı Tezgah Worktable Cabinet	1200x600x850
AND.ADLP.60140	Dolaplı Tezgah Worktable Cabinet	1400x600x850
AND.ADLP.60160	Dolaplı Tezgah Worktable Cabinet	1600x600x850
AND.ADLP.60180	Dolaplı Tezgah Worktable Cabinet	1800x600x850
AND.ADLP.60200	Dolaplı Tezgah Worktable Cabinet	2000x600x850

70'lık Seri / 70's Series

Kod Code	Ürün Adı Description	Ebatlar Dimension
		a x b x c (mm)
AND.ADLP.70120	Dolaplı Tezgah Worktable Cabinet	1200x700x850
AND.ADLP.70140	Dolaplı Tezgah Worktable Cabinet	1400x700x850
AND.ADLP.70160	Dolaplı Tezgah Worktable Cabinet	1600x700x850
AND.ADLP.70180	Dolaplı Tezgah Worktable Cabinet	1800x700x850
AND.ADLP.70200	Dolaplı Tezgah Worktable Cabinet	2000x700x850

TEKNİK ÖZELLİKLER

- Paslanmaz çelikten üretilmektedir.
- Tezgahlar standart olarak sırtlı üretilmektedir.
- Arkası sırtsız tezgahları lütfen bildiriniz.
- Tezgahlar ayarlanabilir ayaklıdır.

TECHNICAL SPECIFICATIONS

- All products are welded and stainless steel.
- Tables are produced with back standartly.
- Please specify if you don't want back with the table.
- All tables are adjustable feet.



60'lık Seri / 60's Series

Kod Code	Ürün Adı Description	Ebatlar Dimension
		a x b x c (mm)
AND.ADLPA.60120	Dolaplı Ara Rafı Cabinet- Intermediate Shelf	1200x600x850
AND.ADLPA.60140	Dolaplı Ara Rafı Cabinet- Intermediate Shelf	1400x600x850
AND.ADLPA.60160	Dolaplı Ara Rafı Cabinet- Intermediate Shelf	1600x600x850
AND.ADLPA.60180	Dolaplı Ara Rafı Cabinet- Intermediate Shelf	1800x600x850
AND.ADLPA.60200	Dolaplı Ara Rafı Cabinet- Intermediate Shelf	2000x600x850

70'lık Seri / 70's Series

Kod Code	Ürün Adı Description	Ebatlar Dimension
		a x b x c (mm)
AND.ADLPA.70120	Dolaplı Ara Rafı Cabinet- Intermediate Shelf	1200x700x850
AND.ADLPA.70140	Dolaplı Ara Rafı Cabinet- Intermediate Shelf	1400x700x850
AND.ADLPA.70160	Dolaplı Ara Rafı Cabinet- Intermediate Shelf	1600x700x850
AND.ADLPA.70180	Dolaplı Ara Rafı Cabinet- Intermediate Shelf	1800x700x850
AND.ADLPA.70200	Dolaplı Ara Rafı Cabinet- Intermediate Shelf	2000x700x850

TEKNİK ÖZELLİKLER

- Paslanmaz çelikten üretilmektedir.
- Tezgahlar standart olarak sırtlı üretilmektedir.
- Arkası sırsız tezgahları lütfen bildiriniz.
- Tezgahlar ayarlanabilir ayaklıdır.

TECHNICAL SPECIFICATIONS

- All products are welded and stainless steel.
- Tables are produced with back standartly.
- Please specify if you don't want back with the table.
- All tables are adjustable feet.



Kod Code	Ürün Adı Description	Ebatlar Dimension
AND.AKST.6060-L	Köşe Tezgahı Sol Corner Table Left	600x600x850
AND.AKST.6060-R	Köşe Tezgahı Sağ Corner Table Right	600x600x850
AND.AKST.7070-L	Köşe Tezgahı Sol Corner Table Left	700x700x850
AND.AKST.7070-R	Köşe Tezgahı Sağ Corner Table Right	700x700x850



AND.AKKT.6060-L

Kod Code	Ürün Adı Description	Ebatlar Dimension
AND.AKKT.6060-L	Köşe Tezgahı Alt Rafı Sol Corner Table with Bottom Shelf Left	600x600x850
AND.AKKT.6060-R	Köşe Tezgahı Alt Rafı Sağ Corner Table with Bottom Shelf Right	600x600x850
AND.AKKT.7070-L	Köşe Tezgahı Alt Rafı Sol Corner Table with Bottom Shelf Left	700x700x850
AND.AKKT.7070-R	Köşe Tezgahı Alt Rafı Sağ Corner Table with Bottom Shelf Right	700x700x850



Kod Code	Ürün Adı Description	Ebatlar Dimension
		a x b x c (mm)
AND.AKTTA.6060-L	Köşe Tezgahı Alt-Ara Rafı Sol Corner Table with Bottom-Intermediate Shelf Left	600x600x850
AND.AKTTA.6060-R	Köşe Tezgahı Alt-Ara Rafı Sağ Corner Table with Bottom-Intermediate Shelf Right	600x600x850
AND.AKTTA.7070-L	Köşe Tezgahı Alt-Ara Rafı Sol Corner Table with Bottom-Intermediate Shelf Left	700x700x850
AND.AKTTA.7070-R	Köşe Tezgahı Alt-Ara Rafı Sağ Corner Table with Bottom-Intermediate Shelf Right	700x700x850



Kod Code	Ürün Adı Description	Ebatlar Dimension
		a x b x c (mm)
AND.APTE.5050	Polietilen Et Kütüğü Polyethylen Meat Block	500x600x850
AND.APTE.6060	Polietilen Et Kütüğü Polyethylen Meat Block	600x600x850
AND.APTE.7070	Polietilen Et Kütüğü Polyethylen Meat Block	700x700x850

- 10 cm polietilen kalınlığı. / 10 cm polyethylen thickness.



Kod Code	Ürün Adı Description	Ebatlar Dimension
		a x b x c (mm)
AND.ABLK.506085	Blok Çekmece Ünitesi Drawers Unit	500x600x850
AND.ABLK.507085	Blok Çekmece Ünitesi Drawers Unit	500x700x850

TEKNİK ÖZELLİKLER

- Çekmeceler paslanmaz çelikten üretilmektedir.
- Çekmece ünitesi standart olarak sırtlı üretilmektedir.
- Arkası sırtsız tezgahları lütfen bildiriniz.
- Tezgahlar ayarlanabilir ayaklıdır.

TECHNICAL SPECIFICATIONS

- Stainless steel.
- Drawers are produced with back standartly.
- Please specifty if you don't want back with the table.
- All tables are adjustable feet.

andora

EVYELİ TEZGAHLAR

- 1 Evyeli Tezgahlar 600 / 700 (Demonte)
- 1 Evyeli Tezgahlar 700 (Demonte)
- 1 Evyeli Tezgahlar 600 / 700 (Demonte)
- 2 Evyeli Tezgahlar 600 / 700 (Demonte)
- 2 Evyeli Tezgahlar 700 (Demonte)
- 2 Evyeli Tezgahlar 600 / 700 (Demonte)
- 3 Evyeli Tezgahlar 600 - 700 (Demonte)

Duvar Rafları

- Duvar Rafları Ayarlanabilir (Demonte)
- Duvar Rafları Perfore Ayarlanabilir (Demonte)

Duvar Dolapları

- Sebze Yıkama Tezgahları / Duvar Dolapları 30/40'lık Seri (Sürgü Kapaklı)

TABLES with SINK

- Work Tables with 1 Sink 600 / 700 (Demounted)
- Work Tables with 1 Sink 700 (Demounted)
- Work Tables with 1 Sink 600 / 700 (Demounted)
- Work Tables with 2 Sink 600 / 700 (Demounted)
- Work Tables with 2 Sink 700 (Demounted)
- Work Tables with 2 Sink 600 / 700 (Demounted)
- Work Tables with 3 Sink 600 - 700 (Demounted)

Wall Shelves

- Wall Shelves Adjustable (Demounted)
- Wall Shelves Perforated Adjustable (Demounted)

Wall Cupboards

- Vegetable Washing Units / Wall Cabinets 30/40' s Serie (Sliding Doors)

Evyeli Tezgahlar Tables with Sink

1 Evyeli Tezgahlar 600 / 700 (Demonte) Work Tables with 1 Sink 600 / 700 (Demounted)

andora



Kod Code	Ürün Adı Description	Ebatlar Dimension	Evye Sink
		a x b x c (mm)	a x b x c (mm)
AND.AE.66085-1E	Tek Evyeli Tezgah Sink with 1 Bowl	600x600x850	500x400x250
AND.AE.76085-1E	Tek Evyeli Tezgah Sink with 1 Bowl	600x700x850	500x400x250
AND.AE.67085-1E	Tek Evyeli Tezgah Sink with 1 Bowl	700x600x850	400x500x300
AND.AE.77085-1E	Tek Evyeli Tezgah Sink with 1 Bowl	700x700x850	500x500x300



Kod Code	Ürün Adı Description	Ebatlar Dimension	Evye Sink
		a x b x c (mm)	a x b x c (mm)
AND.AE.66085-1ET	Tek Evyeli Tezgah Sink with 1 Bowl	600x600x850	500x400x250
AND.AE.76085-1ET	Tek Evyeli Tezgah Sink with 1 Bowl	600x700x850	500x400x250
AND.AE.67085-1ET	Tek Evyeli Tezgah Sink with 1 Bowl	700x600x850	400x500x300
AND.AE.77085-1ET	Tek Evyeli Tezgah Sink with 1 Bowl	700x700x850	500x500x300

- Paslanmaz Çelik. / Stainless Steel.

- Tezgahlar standart olarak sırtlı üretilmektedir. / Tables are produced with back standartly.



Kod Code	Ürün Adı Description	Ebatlar Dimension	Evye Sink
		a x b x c (mm)	a x b x c (mm)
AND.AE.61085-1E-R	Tek Evyeli Tezgah Sağ / Sink with 1 Bowl Right	1000x600x850	500x400x250
AND.AE.61085-1E-L	Tek Evyeli Tezgah Sol / Sink with 1 Bowl Left	1000x600x850	500x400x250
AND.AE.61285-1E-R	Tek Evyeli Tezgah Sağ / Sink with 1 Bowl Right	1200x600x850	500x400x250
AND.AE.61285-1E-L	Tek Evyeli Tezgah Sol / Sink with 1 Bowl Left	1200x600x850	500x400x250
AND.AE.61485-1E-R	Tek Evyeli Tezgah Sağ / Sink with 1 Bowl Right	1400x600x850	500x400x250
AND.AE.61485-1E-L	Tek Evyeli Tezgah Sol / Sink with 1 Bowl Left	1400x600x850	500x400x250
AND.AE.61685-1E-R	Tek Evyeli Tezgah Sağ / Sink with 1 Bowl Right	1600x600x850	500x400x250
AND.AE.61685-1E-L	Tek Evyeli Tezgah Sol / Sink with 1 Bowl Left	1600x600x850	500x400x250



Kod Code	Ürün Adı Description	Ebatlar Dimension	Evye Sink
		a x b x c (mm)	a x b x c (mm)
AND.AE.71085-1E-R	Tek Evyeli Tezgah Sağ / Sink with 1 Bowl Right	1000x700x850	500x500x300
AND.AE.71085-1E-L	Tek Evyeli Tezgah Sol / Sink with 1 Bowl Left	1000x700x850	500x500x300
AND.AE.71285-1E-R	Tek Evyeli Tezgah Sağ / Sink with 1 Bowl Right	1200x700x850	500x500x300
AND.AE.71285-1E-L	Tek Evyeli Tezgah Sol / Sink with 1 Bowl Left	1200x700x850	500x500x300
AND.AE.71485-1E-R	Tek Evyeli Tezgah Sağ / Sink with 1 Bowl Right	1400x700x850	500x500x300
AND.AE.71485-1E-L	Tek Evyeli Tezgah Sol / Sink with 1 Bowl Left	1400x700x850	500x500x300
AND.AE.71685-1E-R	Tek Evyeli Tezgah Sağ / Sink with 1 Bowl Right	1600x700x850	500x500x300
AND.AE.71685-1E-L	Tek Evyeli Tezgah Sol / Sink with 1 Bowl Left	1600x700x850	500x500x300

- Paslanmaz Çelik. / Stainless Steel.

- Tezgahlar standart olarak sırtlı üretilmektedir. / Tables are produced with back standartly.

Evyeli Tezgahlar Tables with Sink

1 Evyeli Tezgahlar 700 (Demonte) Work Tables with 1 Sink 700 (Demounted)

andora



Kod Code	Ürün Adı Description	Ebatlar Dimension	Evye Sink
		a x b x c (mm)	a x b x c (mm)
AND.AE.71485-1EM-R	Tek Evyeli Tezgah Sağ / Sink with 1 Bowl Right	1400x700x850	500x500x300
AND.AE.71485-1EM-L	Tek Evyeli Tezgah Sol / Sink with 1 Bowl Left	1400x700x850	500x500x300
AND.AE.71685-1EM-R	Tek Evyeli Tezgah Sağ / Sink with 1 Bowl Right	1600x700x850	500x500x300
AND.AE.71685-1EM-L	Tek Evyeli Tezgah Sol / Sink with 1 Bowl Left	1600x700x850	500x500x300
AND.AE.71885-1EM-R	Tek Evyeli Tezgah Sağ / Sink with 1 Bowl Right	1800x700x850	500x500x300
AND.AE.71885-1EM-L	Tek Evyeli Tezgah Sol / Sink with 1 Bowl Left	1800x700x850	500x500x300
AND.AE.72085-1EM-R	Tek Evyeli Tezgah Sağ / Sink with 1 Bowl Right	2000x700x850	500x500x300
AND.AE.72085-1EM-L	Tek Evyeli Tezgah Sol / Sink with 1 Bowl Left	2000x700x850	500x500x300



Kod Code	Ürün Adı Description	Ebatlar Dimension	Evye Sink
		a x b x c (mm)	a x b x c (mm)
AND.AE.71485-1EMT-R	Tek Evyeli Tezgah Sağ / Sink with 1 Bowl Right	1400x700x850	500x500x300
AND.AE.71485-1EMT-L	Tek Evyeli Tezgah Sol / Sink with 1 Bowl Left	1400x700x850	500x500x300
AND.AE.71685-1EMT-R	Tek Evyeli Tezgah Sağ / Sink with 1 Bowl Right	1600x700x850	500x500x300
AND.AE.71685-1EMT-L	Tek Evyeli Tezgah Sol / Sink with 1 Bowl Left	1600x700x850	500x500x300
AND.AE.71885-1EMT-R	Tek Evyeli Tezgah Sağ / Sink with 1 Bowl Right	1800x700x850	500x500x300
AND.AE.71885-1EMT-L	Tek Evyeli Tezgah Sol / Sink with 1 Bowl Left	1800x700x850	500x500x300
AND.AE.72085-1EMT-R	Tek Evyeli Tezgah Sağ / Sink with 1 Bowl Right	2000x700x850	500x500x300
AND.AE.72085-1EMT-L	Tek Evyeli Tezgah Sol / Sink with 1 Bowl Left	2000x700x850	500x500x300

- Paslanmaz Çelik. / Stainless Steel.

- Tezgahlar standart olarak sırtlı üretilmektedir. / Tables are produced with back standartly.



Kod Code	Ürün Adı Description	Ebatlar Dimension	Evye Sink
		a x b x c (mm)	a x b x c (mm)
AND.AE.61085-1ET-R	Tek Evyeli Tezgah Sağ / Sink with 1 Bowl Right	1000x600x850	500x400x250
AND.AE.61085-1ET-L	Tek Evyeli Tezgah Sol / Sink with 1 Bowl Left	1000x600x850	500x400x250
AND.AE.61285-1ET-R	Tek Evyeli Tezgah Sağ / Sink with 1 Bowl Right	1200x600x850	500x400x250
AND.AE.61285-1ET-L	Tek Evyeli Tezgah Sol / Sink with 1 Bowl Left	1200x600x850	500x400x250
AND.AE.61485-1ET-R	Tek Evyeli Tezgah Sağ / Sink with 1 Bowl Right	1400x600x850	500x400x250
AND.AE.61485-1ET-L	Tek Evyeli Tezgah Sol / Sink with 1 Bowl Left	1400x600x850	500x400x250
AND.AE.61685-1ET-R	Tek Evyeli Tezgah Sağ / Sink with 1 Bowl Right	1600x600x850	500x400x250
AND.AE.61685-1ET-L	Tek Evyeli Tezgah Sol / Sink with 1 Bowl Left	1600x600x850	500x400x250



Kod Code	Ürün Adı Description	Ebatlar Dimension	Evye Sink
		a x b x c (mm)	a x b x c (mm)
AND.AE.71085-1ET-R	Tek Evyeli Tezgah Sağ / Sink with 1 Bowl Right	1000x700x850	500x500x300
AND.AE.71085-1ET-L	Tek Evyeli Tezgah Sol / Sink with 1 Bowl Left	1000x700x850	500x500x300
AND.AE.71285-1ET-R	Tek Evyeli Tezgah Sağ / Sink with 1 Bowl Right	1200x700x850	500x500x300
AND.AE.71285-1ET-L	Tek Evyeli Tezgah Sol / Sink with 1 Bowl Left	1200x700x850	500x500x300
AND.AE.71485-1ET-R	Tek Evyeli Tezgah Sağ / Sink with 1 Bowl Right	1400x700x850	500x500x300
AND.AE.71485-1ET-L	Tek Evyeli Tezgah Sol / Sink with 1 Bowl Left	1400x700x850	500x500x300
AND.AE.71685-1ET-R	Tek Evyeli Tezgah Sağ / Sink with 1 Bowl Right	1600x700x850	500x500x300
AND.AE.71685-1ET-L	Tek Evyeli Tezgah Sol / Sink with 1 Bowl Left	1600x700x850	500x500x300

- Paslanmaz Çelik. / Stainless Steel.

- Tezgahlar standart olarak sırtlı üretilmektedir. / Tables are produced with back standartyly.

Evyeli Tezgahlar Tables with Sink

2 Evyeli Tezgahlar 600 / 700 (Demonte) Work Tables with 2 Sink 600 / 700 (Demounted)

andora



Kod Code	Ürün Adı Description	Ebatlar Dimension	Evye Sink
		a x b x c (mm)	a x b x c (mm)
AND.AE.61485-2E-R	2 Evyeli Tezgah Sağ / Sink with 2 Bowl Right	1400x600x850	500x400x250
AND.AE.61485-2E-L	2 Evyeli Tezgah Sol / Sink with 2 Bowl Left	1400x600x850	500x400x250
AND.AE.61685-2E-R	2 Evyeli Tezgah Sağ / Sink with 2 Bowl Right	1600x600x850	500x400x250
AND.AE.61685-2E-L	2 Evyeli Tezgah Sol / Sink with 2 Bowl Left	1600x600x850	500x400x250
AND.AE.61885-2E-R	2 Evyeli Tezgah Sağ / Sink with 2 Bowl Right	1800x600x850	500x400x250
AND.AE.61885-2E-L	2 Evyeli Tezgah Sol / Sink with 2 Bowl Left	1800x600x850	500x400x250
AND.AE.62085-2E-R	2 Evyeli Tezgah Sağ / Sink with 2 Bowl Right	2000x600x850	500x400x250
AND.AE.62085-2E-L	2 Evyeli Tezgah Sol / Sink with 2 Bowl Left	2000x600x850	500x400x250



Kod Code	Ürün Adı Description	Ebatlar Dimension	Evye Sink
		a x b x c (mm)	a x b x c (mm)
AND.AE.71485-2E-R	2 Evyeli Tezgah Sağ / Sink with 2 Bowl Right	1400x700x850	400x500x250
AND.AE.71485-2E-L	2 Evyeli Tezgah Sol / Sink with 2 Bowl Left	1400x700x850	400x500x250
AND.AE.71685-2E-R	2 Evyeli Tezgah Sağ / Sink with 2 Bowl Right	1600x700x850	500x500x300
AND.AE.71685-2E-L	2 Evyeli Tezgah Sol / Sink with 2 Bowl Left	1600x700x850	500x500x300
AND.AE.71885-2E-R	2 Evyeli Tezgah Sağ / Sink with 2 Bowl Right	1800x700x850	500x500x300
AND.AE.71885-2E-L	2 Evyeli Tezgah Sol / Sink with 2 Bowl Left	1800x700x850	500x500x300
AND.AE.72085-2E-R	2 Evyeli Tezgah Sağ / Sink with 2 Bowl Right	2000x700x850	500x500x300
AND.AE.72085-2E-L	2 Evyeli Tezgah Sol / Sink with 2 Bowl Left	2000x700x850	500x500x300

- Paslanmaz Çelik. / Stainless Steel.

- Tezgahlar standart olarak sırtlı üretilmektedir. / Tables are produced with back standartly.



Kod Code	Ürün Adı Description	Ebatlar Dimension a x b x c (mm)	Evye Sink a x b x c (mm)
AND.AE.71685-2EM-R	2 Evyeli Tezgah Sağ / Sink with 2 Bowl Right	1600x700x850	400x500x250
AND.AE.71685-2EM-L	2 Evyeli Tezgah Sol / Sink with 2 Bowl Left	1600x700x850	400x500x250
AND.AE.71885-2EM-R	2 Evyeli Tezgah Sağ / Sink with 2 Bowl Right	1800x700x850	500x500x300
AND.AE.71885-2EM-L	2 Evyeli Tezgah Sol / Sink with 2 Bowl Left	1800x700x850	500x500x300
AND.AE.72085-2EM-R	2 Evyeli Tezgah Sağ / Sink with 2 Bowl Right	2000x700x850	500x500x300
AND.AE.72085-2EM-L	2 Evyeli Tezgah Sol / Sink with 2 Bowl Left	2000x700x850	500x500x300



Kod Code	Ürün Adı Description	Ebatlar Dimension a x b x c (mm)	Evye Sink a x b x c (mm)
AND.AE.71685-2EMT-R	2 Evyeli Tezgah Sağ / Sink with 2 Bowl Right	1600x700x850	400x500x250
AND.AE.71685-2EMT-L	2 Evyeli Tezgah Sol / Sink with 2 Bowl Left	1600x700x850	400x500x250
AND.AE.71885-2EMT-R	2 Evyeli Tezgah Sağ / Sink with 2 Bowl Right	1800x700x850	500x500x300
AND.AE.71885-2EMT-L	2 Evyeli Tezgah Sol / Sink with 2 Bowl Left	1800x700x850	500x500x300
AND.AE.72085-2EMT-R	2 Evyeli Tezgah Sağ / Sink with 2 Bowl Right	2000x700x850	500x500x300
AND.AE.72085-2EMT-L	2 Evyeli Tezgah Sol / Sink with 2 Bowl Left	2000x700x850	500x500x300

- Paslanmaz Çelik / Stainless Steel.

- Tezgahlar standart olarak sırtlı üretilmektedir. / Tables are produced with back standartly.

Evyeli Tezgahlar Tables with Sink

2 Evyeli Tezgahlar 600 / 700 (Demonte) Work Tables with 2 Sink 600 / 700 (Demounted)

andora



Kod Code	Ürün Adı Description	Ebatlar Dimension	Evye Sink
		a x b x c (mm)	a x b x c (mm)
AND.AE.61485-2ET-R	2 Evyeli Tezgah Sağ / Sink with 2 Bowl Right	1400x600x850	400x500x250
AND.AE.61485-2ET-L	2 Evyeli Tezgah Sol / Sink with 2 Bowl Right	1400x600x850	400x500x250
AND.AE.61685-2ET-R	2 Evyeli Tezgah Sağ / Sink with 2 Bowl Right	1600x600x850	400x500x250
AND.AE.61685-2ET-L	2 Evyeli Tezgah Sol / Sink with 2 Bowl Right	1600x600x850	400x500x250
AND.AE.61885-2ET-R	2 Evyeli Tezgah Sağ / Sink with 2 Bowl Right	1800x600x850	500x400x250
AND.AE.61885-2ET-L	2 Evyeli Tezgah Sol / Sink with 2 Bowl Right	1800x600x850	500x400x250
AND.AE.62085-2ET-R	2 Evyeli Tezgah Sağ / Sink with 2 Bowl Right	2000x600x850	500x400x250
AND.AE.62085-2ET-L	2 Evyeli Tezgah Sol / Sink with 2 Bowl Right	2000x600x850	500x400x250



Kod Code	Ürün Adı Description	Ebatlar Dimension	Evye Sink
		a x b x c (mm)	a x b x c (mm)
AND.AE.71485-2ET-R	2 Evyeli Tezgah Sağ / Sink with 2 Bowl Right	1400x700x850	400x500x250
AND.AE.71485-2ET-L	2 Evyeli Tezgah Sol / Sink with 2 Bowl Right	1400x700x850	400x500x250
AND.AE.71685-2ET-R	2 Evyeli Tezgah Sağ / Sink with 2 Bowl Right	1600x700x850	500x500x300
AND.AE.71685-2ET-L	2 Evyeli Tezgah Sol / Sink with 2 Bowl Right	1600x700x850	500x500x300
AND.AE.71885-2ET-R	2 Evyeli Tezgah Sağ / Sink with 2 Bowl Right	1800x700x850	500x500x300
AND.AE.71885-2ET-L	2 Evyeli Tezgah Sol / Sink with 2 Bowl Right	1800x700x850	500x500x300
AND.AE.72085-2ET-R	2 Evyeli Tezgah Sağ / Sink with 2 Bowl Right	2000x700x850	500x500x300
AND.AE.72085-2ET-L	2 Evyeli Tezgah Sol / Sink with 2 Bowl Right	2000x700x850	500x500x300

- Paslanmaz Çelik. / Stainless Steel.

- Tezgahlar standart olarak sırtlı üretilmektedir. / Tables are produced with back standartly.



Kod Code	Ürün Adı Description	Ebatlar Dimension	Evye Sink
		a x b x c (mm)	a x b x c (mm)
AND.AE.61885-3E	3 Evyeli Tezgah Sink with 3 Bowl	1800x600x850	400x500x250
AND.AE.71885-3E	3 Evyeli Tezgah Sink with 3 Bowl	1800x700x850	500x500x300
AND.AE.72085-3E	3 Evyeli Tezgah Sink with 3 Bowl	2000x700x850	500x500x300



Kod Code	Ürün Adı Description	Ebatlar Dimension	Evye Sink
		a x b x c (mm)	a x b x c (mm)
AND.AE.61885-3ET	3 Evyeli Alt Rafli Tezgah Sink with 3 Bowled Bottom Shelf	1800x600x850	400x500x250
AND.AE.71885-3ET	3 Evyeli Alt Rafli Tezgah Sink with 3 Bowled Bottom Shelf	1800x700x850	500x500x300
AND.AE.72085-3ET	3 Evyeli Alt Rafli Tezgah Sink with 3 Bowled Bottom Shelf	2000x700x850	500x500x300

- Paslanmaz Çelik. / Stainless Steel.
 - Tezgahlar standart olarak sırtlı üretilmektedir. / Tables are produced with back standartly.

Duvar Rafları Wall Shelves

Duvar Rafları Ayarlanabilir (Demonte) Wall Shelves Adjustable (Demounted)

andora

30'luk Seri / 30's Series

Kod Code	Ürün Adı Description	Ebatlar Dimension
		a x b x c (mm)
AND.AET1.3080	Duvar Rafı Wall Shelf	800x300
AND.AET1.30100	Duvar Rafı Wall Shelf	1000x300
AND.AET1.30120	Duvar Rafı Wall Shelf	1200x300
AND.AET1.30140	Duvar Rafı Wall Shelf	1400x300
AND.AET1.30160	Duvar Rafı Wall Shelf	1600x300
AND.AET1.30180	Duvar Rafı Wall Shelf	1800x300
AND.AET1.30200	Duvar Rafı Wall Shelf	2000x300



Kod Code	Ürün Adı Description	Ebatlar Dimension
		a x b x c (mm)
AND.AET2.3080	Duvar Rafı Wall Shelf	800x300
AND.AET2.30100	Duvar Rafı Wall Shelf	1000x300
AND.AET2.30120	Duvar Rafı Wall Shelf	1200x300
AND.AET2.30140	Duvar Rafı Wall Shelf	1400x300
AND.AET2.30160	Duvar Rafı Wall Shelf	1600x300
AND.AET2.30180	Duvar Rafı Wall Shelf	1800x300
AND.AET2.30200	Duvar Rafı Wall Shelf	2000x300

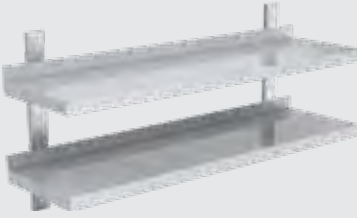

Kod Code	Ürün Adı Description	Ebatlar Dimension
		a x b x c (mm)
AND.AET3.3080	Duvar Rafı Wall Shelf	800x300
AND.AET3.30100	Duvar Rafı Wall Shelf	1000x300
AND.AET3.30120	Duvar Rafı Wall Shelf	1200x300
AND.AET3.30140	Duvar Rafı Wall Shelf	1400x300
AND.AET3.30160	Duvar Rafı Wall Shelf	1600x300
AND.AET3.30180	Duvar Rafı Wall Shelf	1800x300
AND.AET3.30200	Duvar Rafı Wall Shelf	2000x300



40'luk Seri / 40's Series

Kod Code	Ürün Adı Description	Ebatlar Dimension
		a x b x c (mm)
AND.AET1.4080	Duvar Rafı Wall Shelf	800x400
AND.AET1.40100	Duvar Rafı Wall Shelf	1000x400
AND.AET1.40120	Duvar Rafı Wall Shelf	1200x400
AND.AET1.40140	Duvar Rafı Wall Shelf	1400x400
AND.AET1.40160	Duvar Rafı Wall Shelf	1600x400
AND.AET1.40180	Duvar Rafı Wall Shelf	1800x400
AND.AET1.40200	Duvar Rafı Wall Shelf	2000x400

Kod Code	Ürün Adı Description	Ebatlar Dimension
		a x b x c (mm)
AND.AET2.4080	Duvar Rafı Wall Shelf	800x400
AND.AET2.40100	Duvar Rafı Wall Shelf	1000x400
AND.AET2.40120	Duvar Rafı Wall Shelf	1200x400
AND.AET2.40140	Duvar Rafı Wall Shelf	1400x400
AND.AET2.40160	Duvar Rafı Wall Shelf	1600x400
AND.AET2.40180	Duvar Rafı Wall Shelf	1800x400
AND.AET2.40200	Duvar Rafı Wall Shelf	2000x400

Kod Code	Ürün Adı Description	Ebatlar Dimension
		a x b x c (mm)
AND.AET3.4080	Duvar Rafı Wall Shelf	800x400
AND.AET3.40100	Duvar Rafı Wall Shelf	1000x400
AND.AET3.40120	Duvar Rafı Wall Shelf	1200x400
AND.AET3.40140	Duvar Rafı Wall Shelf	1400x400
AND.AET3.40160	Duvar Rafı Wall Shelf	1600x400
AND.AET3.40180	Duvar Rafı Wall Shelf	1800x400
AND.AET3.40200	Duvar Rafı Wall Shelf	2000x400

30'luk Seri / 30's Series

Kod Code	Ürün Adı Description	Ebatlar Dimension
		a x b x c (mm)
AND.AETP1.3080	Duvar Rafı Wall Shelf	800x300
AND.AETP1.30100	Duvar Rafı Wall Shelf	1000x300
AND.AETP1.30120	Duvar Rafı Wall Shelf	1200x300
AND.AETP1.30140	Duvar Rafı Wall Shelf	1400x300
AND.AETP1.30160	Duvar Rafı Wall Shelf	1600x300
AND.AETP1.30180	Duvar Rafı Wall Shelf	1800x300
AND.AETP1.30200	Duvar Rafı Wall Shelf	2000x300

Kod Code	Ürün Adı Description	Ebatlar Dimension
		a x b x c (mm)
AND.AETP2.3080	Duvar Rafı Wall Shelf	800x300
AND.AETP2.30100	Duvar Rafı Wall Shelf	1000x300
AND.AETP2.30120	Duvar Rafı Wall Shelf	1200x300
AND.AETP2.30140	Duvar Rafı Wall Shelf	1400x300
AND.AETP2.30160	Duvar Rafı Wall Shelf	1600x300
AND.AETP2.30180	Duvar Rafı Wall Shelf	1800x300
AND.AETP2.30200	Duvar Rafı Wall Shelf	2000x300

Kod Code	Ürün Adı Description	Ebatlar Dimension
		a x b x c (mm)
AND.AETP3.3080	Duvar Rafı Wall Shelf	800x300
AND.AETP3.30100	Duvar Rafı Wall Shelf	1000x300
AND.AETP3.30120	Duvar Rafı Wall Shelf	1200x300
AND.AETP3.30140	Duvar Rafı Wall Shelf	1400x300
AND.AETP3.30160	Duvar Rafı Wall Shelf	1600x300
AND.AETP3.30180	Duvar Rafı Wall Shelf	1800x300
AND.AETP3.30200	Duvar Rafı Wall Shelf	2000x300

40'luk Seri / 40's Series

Kod Code	Ürün Adı Description	Ebatlar Dimension
		a x b x c (mm)
AND.AETP1.4080	Duvar Rafı Wall Shelf	800x400
AND.AETP1.40100	Duvar Rafı Wall Shelf	1000x400
AND.AETP1.40120	Duvar Rafı Wall Shelf	1200x400
AND.AETP1.40140	Duvar Rafı Wall Shelf	1400x400
AND.AETP1.40160	Duvar Rafı Wall Shelf	1600x400
AND.AETP1.40180	Duvar Rafı Wall Shelf	1800x400
AND.AETP1.40200	Duvar Rafı Wall Shelf	2000x400

Kod Code	Ürün Adı Description	Ebatlar Dimension
		a x b x c (mm)
AND.AETP2.4080	Duvar Rafı Wall Shelf	800x400
AND.AETP2.40100	Duvar Rafı Wall Shelf	1000x400
AND.AETP2.40120	Duvar Rafı Wall Shelf	1200x400
AND.AETP2.40140	Duvar Rafı Wall Shelf	1400x400
AND.AETP2.40160	Duvar Rafı Wall Shelf	1600x400
AND.AETP2.40180	Duvar Rafı Wall Shelf	1800x400
AND.AETP2.40200	Duvar Rafı Wall Shelf	2000x400

Kod Code	Ürün Adı Description	Ebatlar Dimension
		a x b x c (mm)
AND.AETP3.4080	Duvar Rafı Wall Shelf	800x400
AND.AETP3.40100	Duvar Rafı Wall Shelf	1000x400
AND.AETP3.40120	Duvar Rafı Wall Shelf	1200x400
AND.AETP3.40140	Duvar Rafı Wall Shelf	1400x400
AND.AETP3.40160	Duvar Rafı Wall Shelf	1600x400
AND.AETP3.40180	Duvar Rafı Wall Shelf	1800x400
AND.AETP3.40200	Duvar Rafı Wall Shelf	2000x400

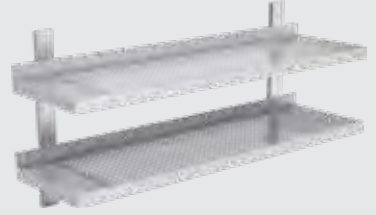
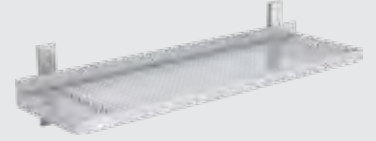

Duvar Dolapları Wall Cupboards

Sebze Yıkama Tezgahları / Duvar Dolapları 30/40'lık Seri (Sürgü Kapaklı) Vegetable Washing Units / Wall Cabinets 30/40's Serie (Sliding Doors)

andora



Kod Code	Ürün Adı Description	Ebatlar Dimension
		a x b x c (mm)
AND.ASY.71285	Sebze Yıkama Tezgahı / Vegetable Washing Unit	1200x700x850
AND.ASY.71485	Sebze Yıkama Tezgahı / Vegetable Washing Unit	1400x700x850



Kod Code	Ürün Adı Description	Ebatlar Dimension
		a x b x c (mm)
AND.ADDS.3120	Duvar Dolabı (Sürgü Kapaklı) / Wall Cabinet (Sliding Doors)	1200x300x600
AND.ADDS.3140	Duvar Dolabı (Sürgü Kapaklı) / Wall Cabinet (Sliding Doors)	1400x300x600
AND.ADDS.3160	Duvar Dolabı (Sürgü Kapaklı) / Wall Cabinet (Sliding Doors)	1600x300x600
AND.ADDS.3180	Duvar Dolabı (Sürgü Kapaklı) / Wall Cabinet (Sliding Doors)	1800x300x600
AND.ADDS.3200	Duvar Dolabı (Sürgü Kapaklı) / Wall Cabinet (Sliding Doors)	2000x300x600



Kod Code	Ürün Adı Description	Ebatlar Dimension
		a x b x c (mm)
AND.ADDS.4120	Duvar Dolabı (Sürgü Kapaklı) / Wall Cabinet (Sliding Doors)	1200x400x600
AND.ADDS.4140	Duvar Dolabı (Sürgü Kapaklı) / Wall Cabinet (Sliding Doors)	1400x400x600
AND.ADDS.4160	Duvar Dolabı (Sürgü Kapaklı) / Wall Cabinet (Sliding Doors)	1600x400x600
AND.ADDS.4180	Duvar Dolabı (Sürgü Kapaklı) / Wall Cabinet (Sliding Doors)	1800x400x600
AND.ADDS.4200	Duvar Dolabı (Sürgü Kapaklı) / Wall Cabinet (Sliding Doors)	2000x400x600

- Paslanmaz Çelik. / Stainless Steel.

Kod Code	Ebatlar Dimension	Filtre Filters
	a x b x c (mm)	
AND.ADDVVK.1074	1000x700x400	1 Filtre / Filters
AND.ADDVVK.1574	1500x700x400	2 Filtre / Filters
AND.ADDVVK.2074	2000x700x400	3 Filtre / Filters
AND.ADDVVK.2574	2500x700x400	4 Filtre / Filters
AND.ADDVVK.3074	3000x700x400	5 Filtre / Filters
AND.ADDVVK.3574	3500x700x400	6 Filtre / Filters
AND.ADDVVK.4074	4000x700x400	6 Filtre / Filters
AND.ADDVVK.4574	4500x700x400	8 Filtre / Filters
AND.ADDVVK.5074	5000x700x400	8 Filtre / Filters

Kod Code	Ebatlar Dimension	Filtre Filters
	a x b x c (mm)	
AND.ADDVVK.1094	1000x900x400	1 Filtre / Filters
AND.ADDVVK.1594	1500x900x400	2 Filtre / Filters
AND.ADDVVK.2094	2000x900x400	3 Filtre / Filters
AND.ADDVVK.2594	2500x900x400	4 Filtre / Filters
AND.ADDVVK.3094	3000x900x400	5 Filtre / Filters
AND.ADDVVK.3594	3500x900x400	6 Filtre / Filters
AND.ADDVVK.4094	4000x900x400	6 Filtre / Filters
AND.ADDVVK.4594	4500x900x400	8 Filtre / Filters
AND.ADDVVK.5094	5000x900x400	8 Filtre / Filters

Kod Code	Ebatlar Dimension	Filtre Filters
	a x b x c (mm)	
AND.ADDVVK.10114	1000x1100x400	1 Filtre / Filters
AND.ADDVVK.15114	1500x1100x400	2 Filtre / Filters
AND.ADDVVK.20114	2000x1100x400	3 Filtre / Filters
AND.ADDVVK.25114	2500x1100x400	4 Filtre / Filters
AND.ADDVVK.30114	3000x1100x400	5 Filtre / Filters
AND.ADDVVK.35114	3500x1100x400	6 Filtre / Filters
AND.ADDVVK.40114	4000x1100x400	6 Filtre / Filters
AND.ADDVVK.45114	4500x1100x400	8 Filtre / Filters
AND.ADDVVK.50114	5000x1100x400	8 Filtre / Filters

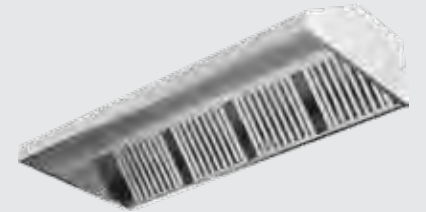
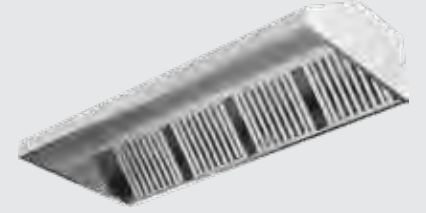
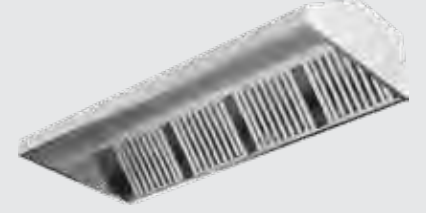

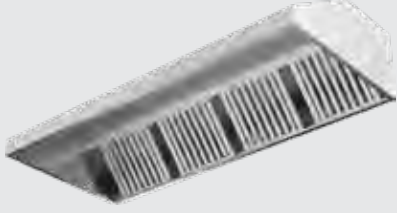

Kod Code	Ebatlar Dimension a x b x c (mm)	Filtre Filters
AND.ADDVVK.1075	1000x700x500	1 Filtre / Filters
AND.ADDVVK.1575	1500x700x500	2 Filtre / Filters
AND.ADDVVK.2075	2000x700x500	3 Filtre / Filters
AND.ADDVVK.2575	2500x700x500	4 Filtre / Filters
AND.ADDVVK.3075	3000x700x500	5 Filtre / Filters
AND.ADDVVK.3575	3500x700x500	6 Filtre / Filters
AND.ADDVVK.4075	4000x700x500	6 Filtre / Filters
AND.ADDVVK.4575	4500x700x500	8 Filtre / Filters
AND.ADDVVK.5075	5000x700x500	8 Filtre / Filters

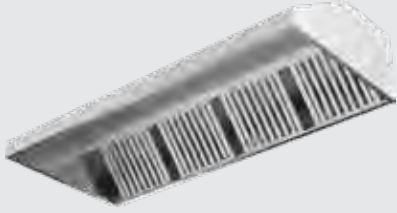

Kod Code	Ebatlar Dimension a x b x c (mm)	Filtre Filters
AND.ADDVVK.1095	1000x900x500	1 Filtre / Filters
AND.ADDVVK.1595	1500x900x500	2 Filtre / Filters
AND.ADDVVK.2095	2000x900x500	3 Filtre / Filters
AND.ADDVVK.2595	2500x900x500	4 Filtre / Filters
AND.ADDVVK.3095	3000x900x500	5 Filtre / Filters
AND.ADDVVK.3595	3500x900x500	6 Filtre / Filters
AND.ADDVVK.4095	4000x900x500	6 Filtre / Filters
AND.ADDVVK.4595	4500x900x500	8 Filtre / Filters
AND.ADDVVK.5095	5000x900x500	8 Filtre / Filters

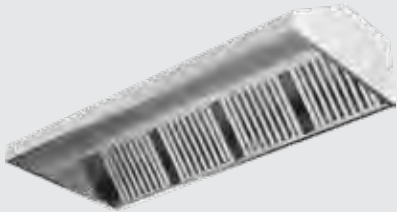

Kod Code	Ebatlar Dimension a x b x c (mm)	Filtre Filters
AND.ADDVVK.10115	1000x1100x500	1 Filtre / Filters
AND.ADDVVK.15115	1500x1100x500	2 Filtre / Filters
AND.ADDVVK.20115	2000x1100x500	3 Filtre / Filters
AND.ADDVVK.25115	2500x1100x500	4 Filtre / Filters
AND.ADDVVK.30115	3000x1100x500	5 Filtre / Filters
AND.ADDVVK.35115	3500x1100x500	6 Filtre / Filters
AND.ADDVVK.40115	4000x1100x500	6 Filtre / Filters
AND.ADDVVK.45115	4500x1100x500	8 Filtre / Filters
AND.ADDVVK.50115	5000x1100x500	8 Filtre / Filters

- Paslanmaz Çelik. / Stainless Steel.

Kod Code	Ebatlar Dimension a x b x c (mm)	Filtre Filters
AND.ADDVLD.1094	1000x900x400	1 Filtre / Filters
AND.ADDVLD.1594	1500x900x400	2 Filtre / Filters
AND.ADDVLD.2094	2000x900x400	3 Filtre / Filters
AND.ADDVLD.2594	2500x900x400	4 Filtre / Filters
AND.ADDVLD.3094	3000x900x400	5 Filtre / Filters
AND.ADDVLD.3594	3500x900x400	6 Filtre / Filters
AND.ADDVLD.4094	4000x900x400	6 Filtre / Filters
AND.ADDVLD.4594	4500x900x400	8 Filtre / Filters
AND.ADDVLD.5094	5000x900x400	8 Filtre / Filters

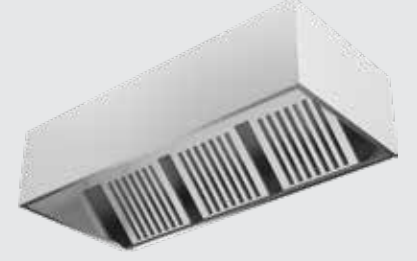

Kod Code	Ebatlar Dimension a x b x c (mm)	Filtre Filters
AND.ADDVLD.10114	1000x1100x400	1 Filtre / Filters
AND.ADDVLD.15114	1500x1100x400	2 Filtre / Filters
AND.ADDVLD.20114	2000x1100x400	3 Filtre / Filters
AND.ADDVLD.25114	2500x1100x400	4 Filtre / Filters
AND.ADDVLD.30114	3000x1100x400	5 Filtre / Filters
AND.ADDVLD.35114	3500x1100x400	6 Filtre / Filters
AND.ADDVLD.40114	4000x1100x400	6 Filtre / Filters
AND.ADDVLD.45114	4500x1100x400	8 Filtre / Filters
AND.ADDVLD.50114	5000x1100x400	8 Filtre / Filters

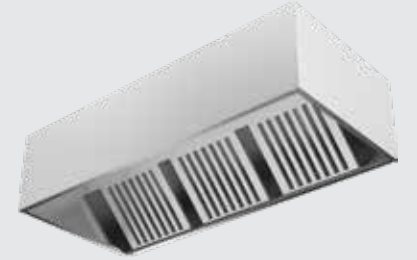

- Paslanmaz Çelik. / Stainless Steel.

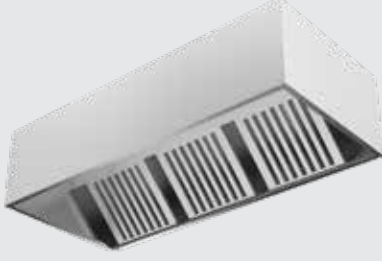

Kod Code	Ebatlar Dimension	Filtre Filters
	a x b x c (mm)	
AND.ADDVLD.1095	1000x900x500	1 Filtre / Filters
AND.ADDVLD.1595	1500x900x500	2 Filtre / Filters
AND.ADDVLD.2095	2000x900x500	3 Filtre / Filters
AND.ADDVLD.2595	2500x900x500	4 Filtre / Filters
AND.ADDVLD.3095	3000x900x500	5 Filtre / Filters
AND.ADDVLD.3595	3500x900x500	6 Filtre / Filters
AND.ADDVLD.4095	5000x900x500	6 Filtre / Filters
AND.ADDVLD.4595	4500x900x500	8 Filtre / Filters
AND.ADDVLD.5095	5000x900x500	8 Filtre / Filters



Kod Code	Ebatlar Dimension	Filtre Filters
	a x b x c (mm)	
AND.ADDVLD.10115	1000x1100x500	1 Filtre / Filters
AND.ADDVLD.15115	1500x1100x500	2 Filtre / Filters
AND.ADDVLD.20115	2000x1100x500	3 Filtre / Filters
AND.ADDVLD.25115	2500x1100x500	4 Filtre / Filters
AND.ADDVLD.30115	3000x1100x500	5 Filtre / Filters
AND.ADDVLD.35115	3500x1100x500	6 Filtre / Filters
AND.ADDVLD.40115	4000x1100x500	6 Filtre / Filters
AND.ADDVLD.45115	4500x1100x500	8 Filtre / Filters
AND.ADDVLD.50115	5000x1100x500	8 Filtre / Filters

- Paslanmaz Çelik. / Stainless Steel.

Kod Code	Ebatlar Dimension	Filtre Filters
	a x b x c (mm)	
AND.AODVL.10194-M	1000x1970x400	2 Filtre / Filters
AND.AODVL.15194-M	1500x1970x400	4 Filtre / Filters
AND.AODVL.20194-M	2000x1970x400	6 Filtre / Filters
AND.AODVL.25194-M	2500x1970x400	8 Filtre / Filters
AND.AODVL.30194-M	3000x1970x400	10 Filtre / Filters
AND.AODVL.35194-M	3500x1970x400	12 Filtre / Filters
AND.AODVL.40194-M	4000x1970x400	12 Filtre / Filters
AND.AODVL.45194-M	4500x1970x400	16 Filtre / Filters
AND.AODVL.50194-M	5000x1970x400	16 Filtre / Filters



Kod Code	Ebatlar Dimension	Filtre Filters
	a x b x c (mm)	
AND.AODVL.10244-M	1000x2470x400	2 Filtre / Filters
AND.AODVL.15244-M	1500x2470x400	4 Filtre / Filters
AND.AODVL.20244-M	2000x2470x400	6 Filtre / Filters
AND.AODVL.25244-M	2500x2470x400	8 Filtre / Filters
AND.AODVL.30244-M	3000x2470x400	10 Filtre / Filters
AND.AODVL.35244-M	3500x2470x400	12 Filtre / Filters
AND.AODVL.40244-M	4000x2470x400	12 Filtre / Filters
AND.AODVL.45244-M	4500x2470x400	16 Filtre / Filters
AND.AODVL.50244-M	5000x2470x400	16 Filtre / Filters



- Paslanmaz Çelik. / Stainless Steel.



Kod Code	Ebatlar Dimension a x b x c (mm)	Filtre Filters
AND.AODVL.10195-M	1000x1970x500	2 Filtre / Filters
AND.AODVL.15195-M	1500x1970x500	4 Filtre / Filters
AND.AODVL.20195-M	2000x1970x500	6 Filtre / Filters
AND.AODVL.25195-M	2500x1970x500	8 Filtre / Filters
AND.AODVL.30195-M	3000x1970x500	10 Filtre / Filters
AND.AODVL.35195-M	3500x1970x500	12 Filtre / Filters
AND.AODVL.40195-M	4000x1970x500	12 Filtre / Filters
AND.AODVL.45195-M	4500x1970x500	16 Filtre / Filters
AND.AODVL.50195-M	5000x1970x500	16 Filtre / Filters



Kod Code	Ebatlar Dimension a x b x c (mm)	Filtre Filters
AND.AODVL.10245-M	1000x2470x500	2 Filtre / Filters
AND.AODVL.15245-M	1500x2470x500	4 Filtre / Filters
AND.AODVL.20245-M	2000x2470x500	6 Filtre / Filters
AND.AODVL.25245-M	2500x2470x500	8 Filtre / Filters
AND.AODVL.30245-M	3000x2470x500	10 Filtre / Filters
AND.AODVL.35245-M	3500x2470x500	12 Filtre / Filters
AND.AODVL.40245-M	4000x2470x500	12 Filtre / Filters
AND.AODVL.45245-M	4500x2470x500	16 Filtre / Filters
AND.AODVL.50245-M	5000x2470x500	16 Filtre / Filters

- Paslanmaz Çelik. / Stainless Steel.

İthal Ürünler
Import Products



andora



İTHAL ÜRÜNLER

Şişe Soğutucular
Buz Makineleri
Kar Buz Makineleri
Soğutmalı - Isıtmalı Teşhir Üniteleri
Soğutmalı Suşhi Teşhir Dolapları
Otomatik Hamur Açma Makinesi
Espresso Kahve Makineleri
Filtre Kahve ve Sıcak Çikolata Makineleri
Bar Blenderi - Hamburger Presi
Katı Meyve Presleri - Portakal Sıkma Makineleri
Portakal Sıkma Makineleri
Hız Kontrollü Mikserler
Çorbalık - Elektrikli Döner Kesme Bıçakları
Mikrodalga Fırınlr - Hızlı Pişirme Fırınları
İndüksiyon Ocakları
El Blenderleri
Gıda Dilimleme Makineleri
Chaffing Dish

IMPORT PRODUCTS

Bottle Coolers
Ice Makers
Ice Flakers
Cold - Hot Display Units
Refrigerated Sushi Display Cases
Automatic Dough Roller Machine
Espresso Coffee Machines
Filter Coffee and Hot Chocolate Machines
Bar Blender - Hamburger Press
Juice Extractor Citrus Press - Orange Juicers
Orange Juicers
Speed Controlled Mixers
Soup Kettles - Electrical Doner Blades
Microwave Oven - Speed Oven
Induction Cookers
Immersion Blender
Food Slicer Machines
Chaffing Dishes



Kod Code	Ürün Adı Description	Ebatlar Dimension a x b x c (mm)	Ağırlık Weight (kg)	Güç Power (kw)	Kapasite Capacity (lt)
AND.ASS.2	2 Kapılı Şiše Soğutucu Bottle Cooler with 2 Doors	920x500x870	42	0.26	208
AND.ASS.3	3 Kapılı Şiše Soğutucu Bottle Cooler with 3 Doors	1380x500x870	52	0.30	310

TEKNİK ÖZELLİKLER

- 220V - 230V -1 +N - 50 60 Hz elektrik gücü.
- PVC kaplı galvaniz sac.
- CFC Free soğutma gazı: R 134A / R 404A
- Dış ortam sıcaklığı: +32 °C
- Fanlı soğutma.
- Dijital termometre ve termostat.
- Otomatik defrost.
- Kapılarda kilit.
- Özel kapı menteşe sistemi.
- Temizlenebilir ve sökülebilir manyetik kapı contası.
- Çarpma Kapaklı.
- Çalışma Sıcaklığı: 2/10 °C

TECHNICAL SPECIFICATIONS

- 220V - 230V -1 +N - 50 60 Hz electrical power.
- PVC coated galvanized steel.
- "CFC Free" refrigerant gas: R 134A / R 404 A
- +32 °C ambient temp.
- Fan cooling.
- Digital thermometer and thermostat.
- Automatic defrosting.
- Lock system in the door.
- Special door hinge system.
- Removable and easy to clean magnetic door.
- Hinged Doors.
- Working temperature: 2/10 °C



Kod Code	Ürün Adı Description	Ebatlar Dimension a x b x c (mm)	Ağırlık Weight (kg)	Net Net (m ³)	Kapasite Capacity (kg)
AND.A30	Buz Makinesi Ice Maker	405x515x750	40	0.16	30
AND.A50	Buz Makinesi Ice Maker	465x595x795	58	0.22	50
AND.A90	Buz Makinesi Ice Maker	715x595x945	69	0.4	90
AND.A125	Buz Makinesi Ice Maker	715x700x1050	89	0.53	125
AND.A175	Buz Makinesi Ice Maker	860x700x1050	95	0.63	175

TEKNİK ÖZELLİKLER

- Alüminyum panelli bakır borulu evaporatör.
- Kayar kapı.
- Paslanmaz çelik gövde.

AND.A30

- 30 kg buz kapasitesi.
- 15 kg depo haznesi.

AND.A50

- 50 kg buz kapasitesi.
- 20 kg depo haznesi.

AND.A90

- 90 kg buz kapasitesi.
- 35 kg depo haznesi.

AND.A125

- 125 kg buz kapasitesi.
- 60 kg depo haznesi.

AND.A175

- 175 kg buz kapasitesi.
- 75 kg depo haznesi.

TECHNICAL SPECIFICATIONS

- Evaporator with aluminium panel and copper pipe.
- Sliding door.
- Stainless steel body.

AND.A30

- Production Capacity: 30 kg/day
- Bin capacity:15 kg

AND.A50

- Production Capacity: 50 kg/day
- Bin capacity:20 kg

AND.A90

- Production Capacity: 90 kg/day
- Bin capacity:35 kg

AND.A125

- Production Capacity: 125 kg/day
- Bin capacity:60 kg

AND.A175

- Production Capacity: 175 kg/day
- Bin capacity:75 kg





Kod Code	Ürün Adı Description	Ebatlar Dimension	Ağırlık Weight	Net Net	Kapasite Capacity
		a x b x c (mm)	(kg)	(m ³)	(kg)
AND.A250	Buz Makinesi Alt Hazne Dahil Ice Maker Bin Included	762x819x1571	137	0.98	250
AND.A300	Buz Makinesi Alt Hazne Dahil Ice Maker Bin Included	762x819x1399	122	0.88	300
AND.A450	Buz Makinesi Alt Hazne Dahil Ice Maker Bin Included	762x819x1831	155	1.14	450

TEKNİK ÖZELLİKLER

- Alüminyum panelli bakır borulu evaporatör.
- Kayar kapı.
- Paslanmaz çelik gövde.

AND.A250

- 250 kg buz kapasitesi.
- 160 kg depo haznesi.

AND.A300

- 300 kg buz kapasitesi.
- 160 kg depo haznesi.

AND.A450

- 450 kg buz kapasitesi.
- 160 kg depo haznesi.

TECHNICAL SPECIFICATIONS

- Evaporator with aluminium panel and copper pipe.
- Sliding door.
- Stainless steel body.

AND.A250

- Production Capacity: 250 kg/day
- Bin capacity:160 kg

AND.A300

- Production Capacity: 300 kg/day
- Bin capacity:160 kg

AND.A450

- Production Capacity: 450 kg/day
- Bin capacity:160 kg





Kod Code	Ürün Adı Description	Ebatlar Dimension a x b x c (mm)	Ağırlık Weight (kg)	Net Net (m ³)	Kapasite Capacity (kg)
AND.A85-K	Kar Buz Makinesi Ice Flaker	465x595x790	55	0.22	85
AND.A150-K	Kar Buz Makinesi Alt Hazne Dahil Ice Flakers Bin Included	559x800x1356	60	0.61	150
AND.A200-K	Kar Buz Makinesi Alt Hazne Dahil Ice Flakers Bin Included	762x819x1646	70	1.03	200
AND.A400-K	Kar Buz Makinesi Alt Hazne Dahil Ice Flakers Bin Included	1219x819x1731	92	1.73	400

TEKNİK ÖZELLİKLER

- Alüminyum panelli bakır borulu evaporatör.
- Kayar kapı.
- Paslanmaz çelik gövde.

AND.A85-K

- 85 kg buz kapasitesi.
- 20 kg depo haznesi.

AND.A150-K

- 150 kg buz kapasitesi.
- 150 kg depo haznesi.

AND.A200-K

- 200 kg buz kapasitesi.
- 220 kg depo haznesi.

AND.A400-K

- 400 kg buz kapasitesi.
- 400 kg depo haznesi.

TECHNICAL SPECIFICATIONS

- Evaporator with aluminium panel and copper pipe.
- Sliding door.
- Stainless steel body.

AND.A85-K

- Production Capacity:85 kg/day
- Bin capacity:20 kg

AND.A150-K

- Production Capacity: 150 kg/day
- Bin capacity:150 kg

AND.A200-K

- Production Capacity: 200 kg/day
- Bin capacity:220 kg

AND.A400-K

- Production Capacity: 400 kg/day
- Bin capacity:400 kg



Kod Code	Ürün Adı Description	Ebatlar Dimension	Ağırlık Weight	Net Net	Güç Power	Kapasite Capacity
		a x b x c (mm)	(kg)	(m ³)	(kw)	(lt)
AND.A120.S	Soğutmalı Teşhir Ünitesi Cold Display Unit	702x568x686	64	0.20	0.16	120
AND.A160.S	Soğutmalı Teşhir Ünitesi Cold Display Unit	880x568x686	71	0.30	0.16	160

TEKNİK ÖZELLİKLER

- 220V / 50 Hz elektrik gücü.
- Çalışma aralığı 0 °C +12 °C
- R-134 A soğutucu gaz.
- Led aydınlatma.
- Çift cam.
- Ayarlanabilir 2 adet raf.
- Dijital sıcaklık kontrolü.

TECHNICAL SPECIFICATIONS

- 220V / 50 Hz electrical power.
- Working temperature: 0 °C +12 °C
- R-134 A refrigerant gas.
- Led lighting system.
- Double glass.
- 2 adjustable shelves.
- Digital temperature control.



Kod Code	Ürün Adı Description	Ebatlar Dimension	Ağırlık Weight	Net Net	Güç Power	Kapasite Capacity
		a x b x c (mm)	(kg)	(m ³)	(kw)	(lt)
AND.A120.I	Isıtmalı Teşhir Ünitesi Hot Display Unit	678x578x670	48	0.20	1.1	120
AND.A160.I	Isıtmalı Teşhir Ünitesi Hot Display Unit	857x578x670	56	0.30	1.5	160

TEKNİK ÖZELLİKLER

- 220V - 50 Hz Enerji.
- Led aydınlatma.
- Ayarlanabilir ısı kontrol.
- Ayarlanabilir 3 adet raf.

TECHNICAL SPECIFICATIONS

- 220V - 50 Hz Energy.
- Led lighting system.
- Thermostatic control.
- 3 adjustable shelves.

İthal Ürünler
Import Products

Soğutmalı Sushi Teşhir Dolapları
Refrigerated Sushi Display Cases

andora

CE



Üstten Fanlı Soğutma Sistemi / Top Fan Cooling System

Kod Code	Ürün Adı Description	Ebatlar Dimension a x b x c (mm)	Ağırlık Weight (kg)	Güç Power (kw)	Kapasite Capacity (gn 1/3)
AND.ASTD-6	Soğutmalı Sushi Teşhir Dolabı Refrigerated Sushi Display Case	1447x387x240	49	0.13	6
AND.ASTD-8	Soğutmalı Sushi Teşhir Dolabı Refrigerated Sushi Display Case	1797x387x240	52	0.13	8

TEKNİK ÖZELLİKLER

- 220V - 230V -1 +N -50 60 Hz elektrik gücü.
- -1/+1 °C çalışma ısısı.
- Temperli bombe cam.
- Açılabilir ve kolay temizlenebilir cam.
- Led aydınlatma.
- Dijital termometre ve termostat.
- Otomatik defrost.
- Üstten ilave soğutma sistemi.
- EASYCLEAN TRAYS SYSTEM® hijyenik kullanım sağlar.

TECHNICAL SPECIFICATIONS

- 220V - 230V -1 +N -50 60 Hz electrical power.
- -1/+1 °C working temperature.
- Tempered curved glass.
- Lifts up glass to remove for cleaning.
- Led lighting.
- Digital thermometer and thermostat.
- Automatic defrosting.
- Additional cooling system from the top.
- EASYCLEAN TRAYS SYSTEM® provide hygienic usage.

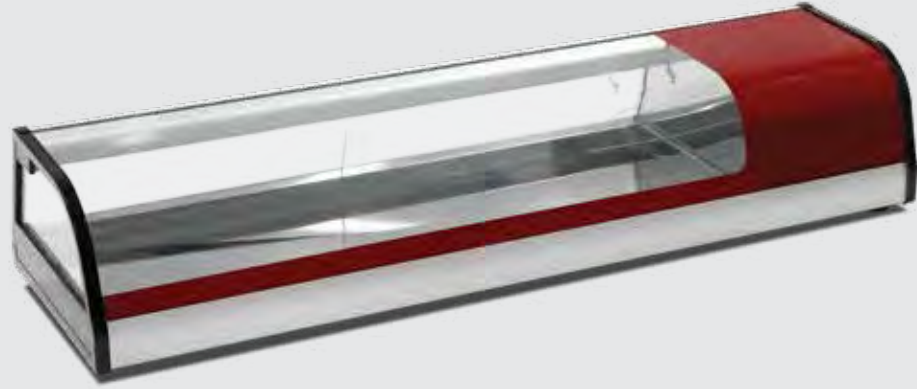
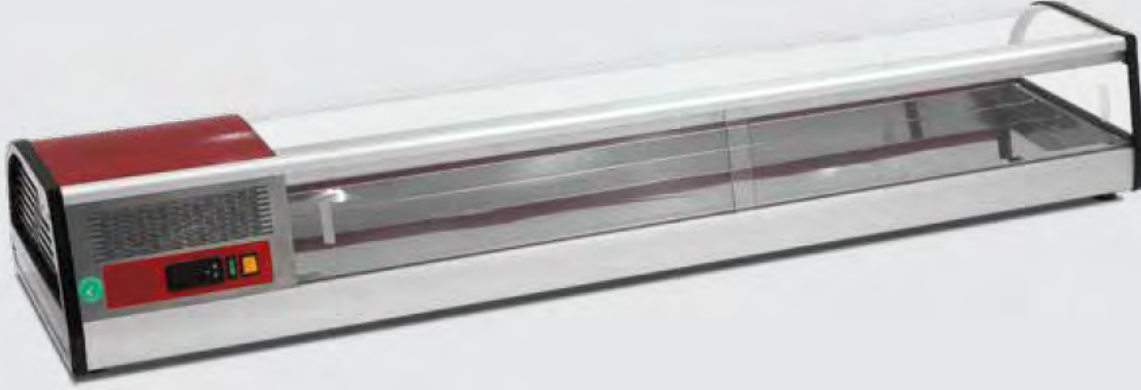

Kod Code	Ürün Adı Description	Ebatlar Dimension	Ağırlık Weight	Net Net	Güç Power	Kapasite Capacity
		a x b x c (mm)	(kg)	(m ³)	(kw)	
AND.ASCR.140	Suşhi Teşhir Ünitesi Sushi Display Unit	1400x400x250	31	125	2	6x1/3
AND.ASCR.180	Suşhi Teşhir Ünitesi Sushi Display Unit	1740x400x250	36	170	2.2	8x1/3

TEKNİK ÖZELLİKLER

- 220V - 230V -1 +N -50 60 Hz elektrik gücü.
- -1/+1 °C çalışma ısısı.
- Temperli bombe cam.
- Açılabilir ve kolay temizlenebilir cam.
- Led aydınlatma.
- Dijital termometre ve termostat.
- Otomatik defrost.

TECHNICAL SPECIFICATIONS

- 220V - 230V -1 +N -50 60 Hz electrical power.
- -1/+1 °C working temperature.
- Tempered curved glass.
- Lifts up glass to remove for cleaning.
- Led lighting.
- Digital thermometer and thermostat.
- Automatic defrosting.



İthal Ürünler
Import Products

Otomatik Hamur Açma Makinesi
Automatic Dough Roller Machine

andora

CE



Kod Code	Ürün Adı Description	Ebatlar Dimension	Ağırlık Weight	Güç Power	Bant Ölçüsü Band Dimension
		a x b x c (mm)	(kg)	(kw)	(mm)
AND.AHA520L	Otomatik Hamur Açma Makinesi Automatic Dough Roller Machine	2950x880x1170	240	0.75	2400x500

TEKNİK ÖZELLİKLER

- 2 sabit ve 2 döner silindir.
- Hamur kalınlığı 0,3 - 35 mm arasında ayarlanabilir.
- Acil stop anahtarı.
- Ek hamur için destek standı.
- Her iki tarafta motorlu taşıma bantları.
- Kolay temizlenir.
- Katlanabilir bant sistemi.

TECHNICAL SPECIFICATIONS

- 2 fixed and 2 swivelling wheels.
- Dough thickness adjustable from 0,3 - 35 mm
- With emergency off-switch.
- Bracket for additional dough roller.
- Motorised conveyor belts on both sides.
- Easy to clean.
- Foldable tape system.





Kod Code	Ürün Adı Description	Ebatlar Dimension	Ağırlık Weight	Güç Power
		a x b x c (mm)	(kg)	(kw)
AND.ACPC-A-6	Tam Otomatik Espresso Kahve Makinesi Full Automatic Espresso Coffee Machines	450x302x625	24	1.4

TEKNİK ÖZELLİKLER

- Tamamı dokunmatik dijital panel
- Tek dokunuşla espresso, cappucino, latte yapabilme özelliği
- Otomatik yıkama özellikli demleme sistemi
- Su kaynağından otomatik su alabilme
- 750 g kapasiteli geniş kahve çekirdeği haznesi
- 2 lt kapasiteli geniş posa haznesi.

TECHNICAL SPECIFICATIONS

- Full touch digital panel, easy to use
- Espresso, cappucino, latte by only one touch
- Brew unit system with auto-clean function
- Auto fill water system with hose to connect water barrel



Kod Code	Ürün Adı Description	Ebatlar Dimension	Ağırlık Weight	Güç Power
		a x b x c (mm)	(kg)	(kw)
AND.AMC.01	Süt Soğutma Dolabı Milk Cooling Cabinet	200x250x320	3	0.7

TEKNİK ÖZELLİKLER

- 1+1 litre tetrapack ambalaj sütü +5 °C'de saklamak için tasarlanmıştır.
- Çift taraflı kullanabilme imkanı.
- Elektrik girişi: 220V~ 1N

TECHNICAL SPECIFICATIONS

- 1+1 liter tetrapack package is prepared for recommendation at +5 °C.
- Double compensated.
- Electric input: 220V~ 1N

İthal Ürünler
Import Products

Filtre Kahve ve Sıcak Çikolata Makineleri
Filter Coffee and Hot Chocolate Machines

andora

CE



Kod Code	Ürün Adı Description	Ebatlar Dimension	Ağırlık Weight	Net Net	Güç Power	Kapasite Capacity
		a x b x c (mm)	(kg)	(m ³)	(kw)	(lt)
AND.AFK.01	Filtre Kahve Makinesi Filter Coffee Machine	205x410x450	6	0.04	1.96	1.7

TEKNİK ÖZELLİKLER

- 220V 50 Hz enerji.
- 5 dakika içinde kaynatma süresi.
- Tank kapasitesi: 1,7 Litre.
- Cezve kapasitesi: 1,7 Litre

TECHNICAL SPECIFICATIONS

- 220V 50 Hz energy.
- Boiling time: 5 minute.
- Tank Capacity: 1,7 Litre.
- Pot Capacity: 1,7 Litre.



Kod Code	Ürün Adı Description	Ebatlar Dimension	Ağırlık Weight	Net Net	Güç Power	Kapasite Capacity
		a x b x c (mm)	(kg)	(m ³)	(kw)	(lt)
AND.ASC.01	Sıcak Çikolata Makinesi Hot Chocolate Machine	410x280x580	3	0.06	1	10

TEKNİK ÖZELLİKLER

- 220V 50 Hz enerji.
- 0/85 °C termostat kontrol ünitesi.

TECHNICAL SPECIFICATIONS

- 220V 50 Hz energy.
- 0/85 °C Thermostat control unit.

**Buz kırabilme özelliği**
Ice crusher blender

Kod Code	Ürün Adı Description	Ebatlar Dimension	Ağırlık Weight	Net Net	Güç Power	Kapasite Capacity
		a x b x c (mm)	(kg)	(m ³)	(kw)	(lt)
AND.ABB.01	Bar Blenderi Bar Blender	200x225x511	5	0.02	1.5	2

TEKNİK ÖZELLİKLER

- 220V 50-60 Hz çalışma gücü.
- Çelik dişli.
- Titanyum bıçak.
- Buz kırabilme özelliği.

TECHNICAL SPECIFICATIONS

- 220V 50-60 Hz operating voltage.
- Steel gearwheel.
- Titanium blade.
- Ice crusher blender.



Kod Code	Ürün Adı Description	Ebatlar Dimension	Ağırlık Weight	Net Net	Güç Power	Kapasite Capacity
		a x b x c (mm)	(kg)	(m ³)	(kw)	(lt)
AND.ABB.01	Bar Blenderi Bar Blender	200x230x490	5	0.03	1.5	2

TEKNİK ÖZELLİKLER

- Günlük kullanım için uygun mekanik kontrol paneli.
- Dayanıklı polikarbon hazne.
- Çelik bıçaklar.

TECHNICAL SPECIFICATIONS

- Mechanical control panel suitable for daily use.
- Durable polycarbonate bowl.
- Steel blades.

İthal Ürünler
Import Products

Katı Meyve Presleri - Portakal Sıkma Makineleri
Juice Extractor Citrus Press - Orange Juicers

andora

CE



Kod Code	Ürün Adı Description	Ebatlar Dimension	Ağırlık Weight	Net Net	Güç Power	Kapasite Capacity
		a x b x c (mm)	(kg)	(m ³)	(kw)	(lt)
AND.AKM.01	Katı Meyve Presi Juice Extractor Citrus Press	205x310x360	4	0.04	0.03	1

TEKNİK ÖZELLİKLER

- 220 - 240V - 430 W motor gücü.
- Otomatik posa atım sistemi.
- Turbo düğmesi.
- 6300 d/dk
- Paslanmaz çelik gövde.

TECHNICAL SPECIFICATIONS

- Motor power: 220 - 240V - 430 W
- Automatic pulp ejection.
- Turbo button.
- 6300 circuit per a minute.
- Stainless steel body.



Kod Code	Ürün Adı Description	Ebatlar Dimension	Ağırlık Weight	Net Net	Güç Power	Kapasite Capacity
		a x b x c (mm)	(kg)	(m ³)	(kw)	(lt)
AND.APR.01	Portakal Sıkma Makinesi Orange Juicer	260x254x470	9	0.03	0.18	220

TEKNİK ÖZELLİKLER

- 220V - 1800 d/dk devir gücü.
- Sessiz,yüksek performanslı,enerji tasarruflu çalışma imkanı.
- Paslanmaz çelik gövde.

TECHNICAL SPECIFICATIONS

- 220V - 1800 rpm motor power.
- Energy saving usage with silent operation.
- Stainless steel body.



Kod Code	Ürün Adı Description	Ebatlar Dimension	Ağırlık Weight	Net Net	Güç Power	Kapasite Capacity
		a x b x c (mm)	(kg)	(m ³)	(kw)	(lt)
AND.APR.02	Portakal Sıkma Makinesi Paslanmaz Çelik Orange Juicer Stainless Steel	280x200x470	9	0.03	0.23	340

TEKNİK ÖZELLİKLER

- 220V - 980 d/dk devir gücü.
- Sessiz,yüksek performanslı,enerji tasarruflu çalışma imkanı.
- Paslanmaz çelik gövde ve sıkacak haznesi.

TECHNICAL SPECIFICATIONS

- 220V - 980 rpm motor power.
- Energy saving usage with silent operation.
- Stainless steel body on top reservoir.



Kod Code	Ürün Adı Description	Ebatlar Dimension	Ağırlık Weight	Net Net	Kapasite Capacity
		a x b x c (mm)	(kg)	(m ³)	(lt)
AND.APR.03	Portakal Sıkma Makinesi Manuel Citrus Juicer	280x200x470	9	0.03	110

İthal Ürünler
Import Products

Hız Kontrollü Mikserler
Speed Controlled Mixers

andora

CE



Kod Code	Ürün Adı Description	Ebatlar Dimension	Ağırlık Weight	Net Net	Güç Power	Kapasite Capacity
		a x b x c (mm)	(kg)	(m ³)	(kw)	(lt)
AND.AMK.107	Hız Kontrollü Mikser Speed Controlled Mixer	415x250x410	17	0.04	0.32	7

TEKNİK ÖZELLİKLER

- 220V 50 Hz Enerji.
- Çıkarılabilir paslanmaz çelik kazan.
- Hijyenik ve emniyetli kullanım.
- 1 adet çırpma teli.
- 1 adet hamur baltası.
- 1 adet çırpma paleti.

TECHNICAL SPECIFICATIONS

- 220V 50 Hz Energy.
- Removable stainless steel tank.
- Safety switch and hygienic usage.
- 1 Of Whisk.
- 1 Of Dough hook.
- 1 Of Mixing Paddle.



Kod Code	Ürün Adı Description	Ebatlar Dimension	Ağırlık Weight	Net Net	Güç Power	Kapasite Capacity
		a x b x c (mm)	(kg)	(m ³)	(kw)	(lt)
AND.AMK.20	3 Hızlı Mikser 3 Speed Mixer	420x520x760	80	0.17	0.75	20

TEKNİK ÖZELLİKLER

- 220V 50 Hz Enerji.
- Çıkarılabilir paslanmaz çelik kazan.
- Hijyenik ve emniyetli kullanım.
- 1 adet çırpma teli.
- 1 adet hamur baltası.
- 1 adet çırpma paleti.

TECHNICAL SPECIFICATIONS

- 220V 50 Hz Energy.
- Removable stainless steel tank.
- Safety switch and hygienic usage.
- 1 Of Whisk.
- 1 Of Dough hook.
- 1 Of Mixing Paddle.



Kod Code	Ürün Adı Description	Ebatlar Dimension	Ağırlık Weight	Net Net	Güç Power	Kapasite Capacity
		a x b x c (mm)	(kg)	(m ³)	(kw)	(lt)
AND.ACRP.01-P	Çorbalık - Paslanmaz Gövdeli Soup Kettle Stainless Steel Body	360x355x200	17	0.03	0.4	10
AND.ACRP.01	Çorbalık Statik Boyalı Soup Kettle Static Painted	360x400x200	18	0.03	0.4	8

TEKNİK ÖZELLİKLER

- 220V 50 Hz çalışma gücü.
- Çıkarılabilir paslanmaz çelik iç hazne.
- Hijyenik ve emniyetli kullanım.

TECHNICAL SPECIFICATIONS

- 220V 50 Hz operating voltage.
- Removable stainless steel reservoir.
- Hygienic and safety usage.



Kod Code	Ürün Adı Description	Ebatlar Dimension	Ağırlık Weight	Net Net	Güç Power
		a x b x c (mm)	(kg)	(m ³)	(kw)
AND.A100E	Elektrikli Döner Kesme Bıçağı Electrical Doner Blade	113x190x150	3	0.05	0.23
AND.AD.01	Düz Bıçak Smooth Blade	Ø10			
AND.AT.01	Tırtırlı Bıçak Knurled Blade	Ø10			

TEKNİK ÖZELLİKLER

- 220V - 2200 D/Dk motor gücü.
- Bıçak çapı: 100 mm
- Kesme kalınlığı: 0 ~ 8 mm
- Bıçak bileme aparatı.

TECHNICAL SPECIFICATIONS

- Motor power: 2200 rpm 220V
- Blade diameter: 100 mm
- Cutting thickness: 0 ~ 8 mm
- Blade sharpening tool

İthal Ürünler
Import Products

Mikrodalga Fırınlar - Hızlı Pişirme Fırınları
Microwave Oven - Speed Oven

andora



Kod Code	Ürün Adı Description	Ebatlar Dimension	Ağırlık Weight	Net Net	Güç Power
		a x b x c (mm)	(kg)	(m ³)	(kw)
AND.AMD.01	Mikrodalga Fırın (Endüstriyel Tip) Microwave Oven (Industrial Type)	511x421x285	25	0.06	1

TEKNİK ÖZELLİKLER

- 220V 50 Hz enerji
- 25 lt kapasite.
- Dokunmatik-Led ışıklı kontrol ekranı.
- Paslanmaz çelik iç ve dış çerçeve.
- Farklı çalışma seviyeleri.
- 10-8 dk ayarlı zamanlayıcı

TECHNICAL SPECIFICATIONS

- 220V 50 Hz operating voltage.
- Capacity: 25 lt
- Touch screen LCD control panel.
- Stainless steel interior and out frame.
- Different levels of operating.
- Timer: 10-8 minute.



Kod Code	Ürün Adı Description	Ebatlar Dimension	Ağırlık Weight	Net Net	Güç Power	Kapasite Capacity
		a x b x c (mm)	(kg)	(m ³)	(kw)	(lt)
AND.AHPF.01	Hızlı Pişirme Fırını - Dokunmatik Speed Oven - Touch Screen	460x603x681	88	0.18	3.3	17

TEKNİK ÖZELLİKLER

- Pişirme süresini %80'e kadar azaltır.
- Ön pişirme için ideal.
- 5" dokunmatik ekran.
- Ayarlanabilir fan (10-100%)
- USB girişi.
- 1024 adet tarif saklama hafızası.
- Kolay temizlenebilir.
- Elektrik Bağlantısı: 230 Volt / 1L / 50 Hz

TECHNICAL SPECIFICATIONS

- Reduces cooking times by up to 80%
- Ideal for front cooking.
- 5" Touch Screen.
- Variably adjustable fan (10-100%)
- USB Port.
- 1024 Recipes storable.
- Easy to clean.
- Electric connection: 230 Volt / 1 L / 50 Hz





Kod Code	Ürün Adı Description	Ebatlar Dimension	Ağırlık Weight	Net Net	Güç Power
		a x b x c (mm)	(kg)	(m ³)	(kw)
AND.AIDW.02	İndüksiyon Wok Ocağı Induction Wok Cooker	340x440x120	8	0.02	0.5 - 3



Kod Code	Ürün Adı Description	Ebatlar Dimension	Ağırlık Weight	Net Net	Güç Power
		a x b x c (mm)	(kg)	(m ³)	(kw)
AND.AID.01	İndüksiyon Ocağı Induction Cooker	340x440x120	8	0.02	0.5 - 3



Kod Code	Ürün Adı Description	Ebatlar Dimension	Ağırlık Weight	Net Net	Güç Power
		a x b x c (mm)	(kg)	(m ³)	(kw)
AND.AID01-A	Ankastre İndüksiyon Ocağı Dropin Induction Cooker	430x326x110	6	0.02	3.5

TEKNİK ÖZELLİKLER

- 220V / 50 Hz enerji
- Seramik tabla.
- Zaman ayarlı kontrol panosu.

TECHNICAL SPECIFICATIONS

- 220V / 50 Hz energy.
- Ceramic pleyt.
- Control panel with timer.



Kod Code	Ürün Adı Description	Ebatlar Dimension a x b x c (mm)	Ağırlık Weight (kg)	Net Net (m ³)	Güç Power (kw)	Kapasite Capacity (lt)
AND.ABLE.01	El Blenderi 20 cm (Çırpıcı ve Kesici) Immersion Blender 20 (Wisk Tool and Cutter)	93x163x560	3.4	0.02	350	20-40
AND.ABLE.02	El Blenderi 25 cm (Çırpıcı ve Kesici) Immersion Blender 25 cm (Wisk Tool and Cutter)	93x163x560	4.5	0.04	500	20-100

TEKNİK ÖZELLİKLER

AND.ABLE.01

- Mikser Uzunluğu: 250 mm
- Kesici Uzunluğu: 200 mm
- Motor Gücü: 350 Watt
- Motor Devri: 4000-16000 rpm

AND.ABLE.02

- Mikser Uzunluğu: 250 mm
- Kesici Uzunluğu: 250 mm
- Motor Gücü: 500 Watt
- Motor Devri: 4000-16000 rpm

TECHNICAL SPECIFICATIONS

AND.ABLE.01

- Mixer Length: 250 mm
- Whisk Length: 200 mm
- Motor Power: 350 Watt
- Motor Speed: 4000-16000 rpm

AND.ABLE.02

- Mixer Length: 250 mm
- Whisk Length: 250 mm
- Motor Power: 500 Watt
- Motor Speed: 4000-16000 rpm





Kod Code	Ürün Adı Description	Ebatlar Dimension	Ağırlık Weight	Net Net	Güç Power	Bıçak Çapı Diameter
		a x b x c (mm)	(kg)	(m ³)	(kw)	(mm)
AND.AGD.220	Gıda Dilimleme Makinesi Food Slicer Machine	410x400x350	12	0.06	0.21	220
AND.AGD.250	Gıda Dilimleme Makinesi Food Slicer Machine	535x475x490	16	0.12	0.24	250
AND.AGD.300	Gıda Dilimleme Makinesi Food Slicer Machine	575x412x460	16	0.11	0.27	300

TEKNİK ÖZELLİKLER

- 220V - 50 Hz Elektrik bağlantısı.
- Hijyenik ve paslanmaz gövde.
- Anodiz alüminyumdan imal.
- Bıçak bileme aparatı.
- Ayarlanabilir kesme kalınlığı.

TECHNICAL SPECIFICATIONS

- 220V - 50 Hz Electrical connection.
- Hygienic and stainless steel body.
- Manufactured by anodised aluminium.
- Blade sharpener tool.
- Adjustable slice thickness.



Kod Code	Ürün Adı Description	Ebatlar Dimension	Ağırlık Weight	Net Net
		a x b x c (mm)	(kg)	(m ³)
AND.AHM.01	Hamburger Presi Hamburger Press	275x220x295	8	0.22

TEKNİK ÖZELLİKLER

- 130 mm et kesme çapı.
- Paslanmaz çelik gövde.

TECHNICAL SPECIFICATIONS

- Meat diameter: 130 mm
- Stainless steel body.



Kod Code	Ürün Adı Description	Ebatlar Dimension
		a x b x c (mm)



AND.ACHF.01	Dikdörtgen Reşo 1/1 Gn Cam Kapak İndüksiyon Taban Rectangle Chaffing Dish 1/1 Gn Glass Lid Induction Bottom	275x220x295
-------------	--	-------------

AND.ACHF.01A	Dikdörtgen Reşo Alt Standı 1/1 Gn Rectangle Chaffing Dish Bottom Stand 1/1 Gn	275x220x295
--------------	--	-------------



Kod Code	Ürün Adı Description	Ebatlar Dimension
		a x b x c (mm)



AND.ACHF.02	Kare Reşo 2/3 Gn Cam Kapak İndüksiyon Taban Square Chaffing Dish 2/3 Gn Glass Lid Induction Bottom	275x220x295
-------------	---	-------------

AND.ACHF.02A	Kare Reşo Alt Standı 2/3 Gn Square Chaffing Dish Bottom Stand 2/3 Gn	275x220x295
--------------	---	-------------



AND.AID01-A	Ankastre İndüksiyon Ocağı Dropin Induction Cooker	430x326x110
-------------	--	-------------



Kod Code	Ürün Adı Description	Ebatlar Dimension
		a x b x c (mm)

AND.ACHF.03	Yuvarlak Çorbalık 12 Lt Cam Kapak İndüksiyon Taban Round Soup Bowl 12 Lt Glass Lid Induction Bottom	275x220x295
-------------	--	-------------



AND.ACHF.03A	Yuvarlak Çorbalık Alt Standı Round Soup Bowl Bottom Stand	275x220x295
--------------	--	-------------



Kod Code	Ürün Adı Description	Ebatlar Dimension
		a x b x c (mm)

AND.ARZ5.01	Yuvarlak İndüksiyon Ocak 800W Round Induction Cooker Power 800W	275x220x295
-------------	--	-------------

AND.ACHF.01, AND.ACHF.02, AND.ACHF.03 modeller için kullanılır. Used for AND.ACHF.01, AND.ACHF.02, AND.ACHF.03 models.



Kod Code	Ürün Adı Description	Ebatlar Dimension
		a x b x c (mm)
AND.ACHF.05	Yuvarlak Kapak Çorbalık Round Roll Top Soup Station	520x485x470



Kod Code	Ürün Adı Description	Ebatlar Dimension
		a x b x c (mm)
AND.ACHF.04	Roll Top Kapak Chaffing Dish Roll Top Chaffing Dish	640x490x440



Kod Code	Ürün Adı Description	Ebatlar Dimension
		a x b x c (mm)
AND.ADSP.01	Süt Dispenseri 6 lt. Milk Dispenser 6 lt.	242x275x435



Kod Code	Ürün Adı Description	Ebatlar Dimension
		a x b x c (mm)
AND.ADSP.02	Kahve Dispenseri 19 lt. Coffee Dispenser 19 lt.	364x364x580



Kod Code	Ürün Adı Description	Ebatlar Dimension
		a x b x c (mm)
AND.ADSP.03	İçecek Dispenseri 12 lt. Juice Dispenser 12 lt.	364x364x460



Kod Code	Ürün Adı Description	Ebatlar Dimension
		a x b x c (mm)
AND.ADSP.04	İçecek Dispenseri 12 lt. Juice Dispenser 12 lt.	270x360x530



AND.ADPS.04A	Çiftli İçecek Dispenseri 2x8 lt. Juice Dispenser 2x8 lt.	580x360x590
--------------	---	-------------

AND.ADSP.04 AND.ADPS.04A

TURKEYNER

Import & Export & Logistic

www.turkeyner.com



Gazi Mustafa Kemal Avenue No: 47/12

Maltepe / Çankaya / ANKARA / TURKEY



+90 312 229 93 66



export@turkeyner.com



www.turkeyner.com



+90 312 229 93 66



<https://www.linkedin.com/company/turkeyner/>



<https://www.facebook.com/Turkeyner/>