

# BENDED METAL ACCESSORIES CATALOGUE

<b>TURKEY HEAD OFFICE</b> ✉ G.M.K. Avenue 47/12 Maltepe – Ankara ☎ +90 312 2299366	<b>ALGERIA BRANCH OFF.</b> ✉ Nouvelle Ville Constantine ☎ +213 771374644	<b>GHANA BRANCH OFF.</b> ✉ H/N 20, Coca Loop, East Legon, Accra ☎ +233 5509144484	<b>CÔTE D'IVOIRE BRANCH</b> ✉ Marcory Zone 4 Rue Marconi, Abidjan ☎ +225 0748999899	<b>NIGER BRANCH OFF.</b> ✉ Niger Plateau Issa Beri, Niamey ☎ +227 99715767	<b>ESTONIA BRANCH OFF.</b> ✉ Talinn ☎ + 372 56179772
---	---	--	--	---	--





















<b>1. HOOKS AND CLIPS FOR COATING HANGERS</b>	<b>4</b>
1.1- Hooks	
1.2- Clips	
<b>2. BUCKET HANDLES AND RINGS</b>	<b>7</b>
2.1- Bucket Handles	
2.2- Bucket Handle Plastics	
2.3- Ring Closures	
<b>3. MANICURE AND COIFFEUR ACCESSORIES</b>	<b>8</b>
3.1- Hairgrips	
3.2- Nailfiles	
3.3- Nail Clipper	
3.4- Tweezer	
3.5- Manicure Set	
3.6- Foot File	
<b>4. ELECTRO PLATING AND HEAT TREATMENT</b>	<b>9</b>
<b>5. TEXTILE AND UNDERWEAR ACCESSORIES</b>	<b>10</b>
5.1- Hooks and eyes for Brassiere	
5.2- Bra Wire for Brassiere	
5.3- Metal and plastic Sliders for Brassiere	
5.4- Textile Needles	
5.5- Shirt Clips	
<b>6. WIRE HANGER AND WIRE FORM</b>	<b>13</b>
6.1- Wire Hangers	
6.2- Wireforming	
6.3- Bandforming	
6.4- Cutting Mold	
6.5- U Form Hooks	
6.6- S Form Hooks	
6.7- Transport Rings	
6.8- Label Clips	











<b>7. STATIONARY</b>	<b>15</b>
7.1- Paper Clip	
7.2- Paper Pins	
<b>8. BALL CHAINS</b>	<b>16</b>
<b>9. SPRING AND COOL INDUSTRY</b>	<b>17</b>
<b>10. GREENHOUSE ACCESSORIES</b>	<b>20</b>
10.1- Agricultural Hooks	
<b>11. WIRES</b>	<b>20</b>
11.1- Painted Wire	
11.2- Nylon Coated Wire	
11.3- Pet Coated Wire	
11.4- Pet Coated Flat Wire	
11.5- Brass Coated Wire	
<b>12. PACKING ACCESSORIES</b>	<b>21</b>
12.1- Crate Clips	
<b>13. CURTAIN ACCESSORIES</b>	<b>22</b>
13.1- Snap-In Installation Clip	
13.2- Metal L Bracket	
13.3- Bracket Set for Curtain Track	
13.4- Demountable Curtain Track	

# 1. HOOKS AND CLIPS FOR COATING HANGERS























*andora*

## 1.1 HOOKS

			
GA MODEL	GH MODEL	GO MODEL	HB MODEL
			
HP MODEL	KA MODEL	KE MODEL	KS MODEL
			
OÇ MODEL	OT MODEL	TL MODEL	TL2 MODEL
			
TZ MODEL	ZC MODEL	ZN MODEL	ZU MODEL
			
TIE HANGER HOOK	AND CLASSIC AMERICAN	NAIL HEADED	SCARF HANGER HOOK

 <p>GA CHINESE HOOK</p>	 <p>GA MODEL KNOTTY</p>	 <p>BEAKED Y TYPE</p>	 <p>HRC TYPE</p>
 <p>HRY TYPE</p>	 <p>HRY-2 TYPE</p>	 <p>SCARF HOOK With CORNER</p>	 <p>CLASSIC AMERICAN With CORNER</p>
 <p>WITHOUT KNOB</p>	 <p>O TYPE CLASSIC AMERICAN</p>	<p><b>* Surface coating options: Zinc, Black Zinc, Nickel, Matt Nickel, Satin, Yellow Zinc, Yellow Passivation Zinc, Electro Ferritic Coating, Brass Coating, Copper Coating and Electrostatic Powder Coating</b></p>	

## 1.2 CLIPS

 <p>NORMAL M TYPE (0,80x7,5)</p>	 <p>CORNER TYPE 0,6x13,5</p>	 <p>MINI M TYPE 0,40x5,5</p>	 <p>BUTTERFLY 0,40x7,0</p>
 <p>FLAT CLIPS 0,42x12,5</p>	 <p>A10 CLIPS 0,50x12,5</p>	 <p>LCR TYPE 0,50x12,5</p>	 <p>FBI NO TIE PIECE 0,60x7,0</p>
 <p>MINI M TYPE 0,60x7,0</p>	 <p>CV CLIPS 0,60x8,0</p>	 <p>SHUTTLE TONGS 0,60x8,0</p>	 <p>S2 CLIPS 0,60x8,0</p>
 <p>SINGLE TIE PIECE 0,70x7,5</p>	 <p>NCF CLIPS 0,70x8,0</p>	 <p>NCL CLIPS700 0,70x13,5</p>	 <p>MINI U FLAT EAR 0,80x7,0</p>
 <p>NORMAL M TYPE 0,80x7,5</p>	 <p>NORMAL U TYPE 0,80x7,5</p>	 <p>SPIP 0,90x8,0</p>	 <p>KBG CLIPS 0,80x8,0</p>
 <p>KBG-2 CLIPS 0,80x8,0</p>	 <p>CUTTED EAR NCH 0,90x9,0</p>	 <p>MCH 653 CLIPS 1,0x7,5</p>	<p><b>* Please contact us for your special requests.</b></p> <p><b>* Surface coating options:</b>  Zinc, Black Zinc, Nickel, Matt Nickel, Satin, Yellow Zinc, Yellow Passivation Zinc, Electro Ferritic Coating, Brass Coating, Copper Coating and Electrostatic Powder Coating</p>

















## 2. BUCKET HANDLES AND RINGS

*andora*

### 2.1 BUCKET HANDLE

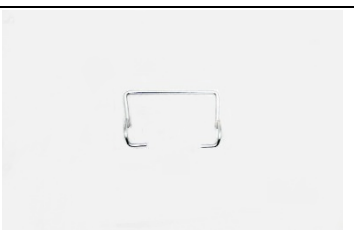
### 2.2 BUCKET HANDLE PLASTICS

### 2.3- RING CLOSURES

			
20 Lt Bucket Handle 4,00 Galvanized Wire	6/1 Bucket Handle 4,00 Galvanized Wire	10/1 Bucket Handle 4,00 Galvanized Wire	10,4 Bucket Handle 3,20 mm Galvanized Wire
			
25-1 Bucket Handle	3 Lt Bucket Handle 2,80 Galvanized Wire	6/1 Bucket Handle 4,00 Galvanized Wire	10-1 Bucket Handle
			
10 L Handle	Jumbo Bucket Handle with Plastic 3,50 Galvanized Wire	22-1 Bucket Handle	17 Lt Bucket Handle 4,00 Galvanized Wire
			
Jumbo Bucket Handle 3,50 Galvanized Handle	Versatile Bucket Handle Plastics	Open Ring Closures Ø 140 mm- 330 mm	Overlapped Ring Closures Ø 140 mm- 330 mm







# 3. MANICURE AND COIFFEUR ACCESSORIES

*andora*



## 3.1 HAIRGRIPS

 <p>TK 40 BLACK</p>	 <p>TK 40 GOLD</p>	 <p>TK 50D BLACK</p>	 <p>TK 80 (40 Mm) Single Head</p>
 <p>TK 80 (70 Mm) Single Head Black</p>	 <p>TK 126 Black</p>		

## 3.2 NAILFILES

 <p>No: 0</p>	 <p>No: 1</p>	 <p>No: 2</p>	 <p>No: 3</p>
 <p>No: 4</p>	 <p>No: 5</p>		

## 3.3 NAIL CLIPPER

 <p>SMALL (BABY)</p>	 <p>MEDIUM</p>	 <p>LARGE</p>
---	--	--



### 3.4 TWEEZER



### 3.5 MANICURE SET

### 3.6 FOOT FILES



## 4. ELECTRO PLATING AND HEAT TREATMENT

*andora*

\* Please contact us for your special requests.

# 5. TEXTILE AND UNDERWEAR ACCESSORIES

*andora*

## 5.1 HOOKS AND EYES FOR BRASSIERE

 <p>TK 601 1x2 20x42 mm</p>	 <p>TK 602 1x3 20x55 mm</p>	 <p>TK 603 2x2 28x42 32x42 40x42 mm</p>	 <p>TK 605 2x3 28x55 30x55 32x55 34x55 38x55mm</p>
 <p>TK 607 3x3 40x55 mm 45x55 mm 50x55 mm 60x55 mm</p>	 <p>TK 608 3x2 50x42 mm</p>	 <p>TK 609 3x1 50x25 mm 60x25 mm</p>	 <p>TK 610 2x1 40x25 mm</p>
 <p>TK 611 2x3 3x3 Size: Up to customer's request Bra extender with elastic</p>	<p>Size: Up to customer's request</p> <p>Sewing: Normal-Invisible</p>		
 <p>TK 621 Hook&amp; Eye Tape for Body (Cotton or nylon fabric)</p>	 <p>TK 622 Hook&amp; Eye Tapes (Cotton or nylon fabric)</p>	 <p>TK 626 Riveted Hook&amp; Eye Tape (Cotton or nylon fabric)</p>	
 <p>TK 652 Hook&amp; Eyes NRO Nylon Coated, Nickel Free, Nickel Plated, Brass Plated, Gold Plated</p>			

## 5.2 BRA WIRE FOR BRASSIERE

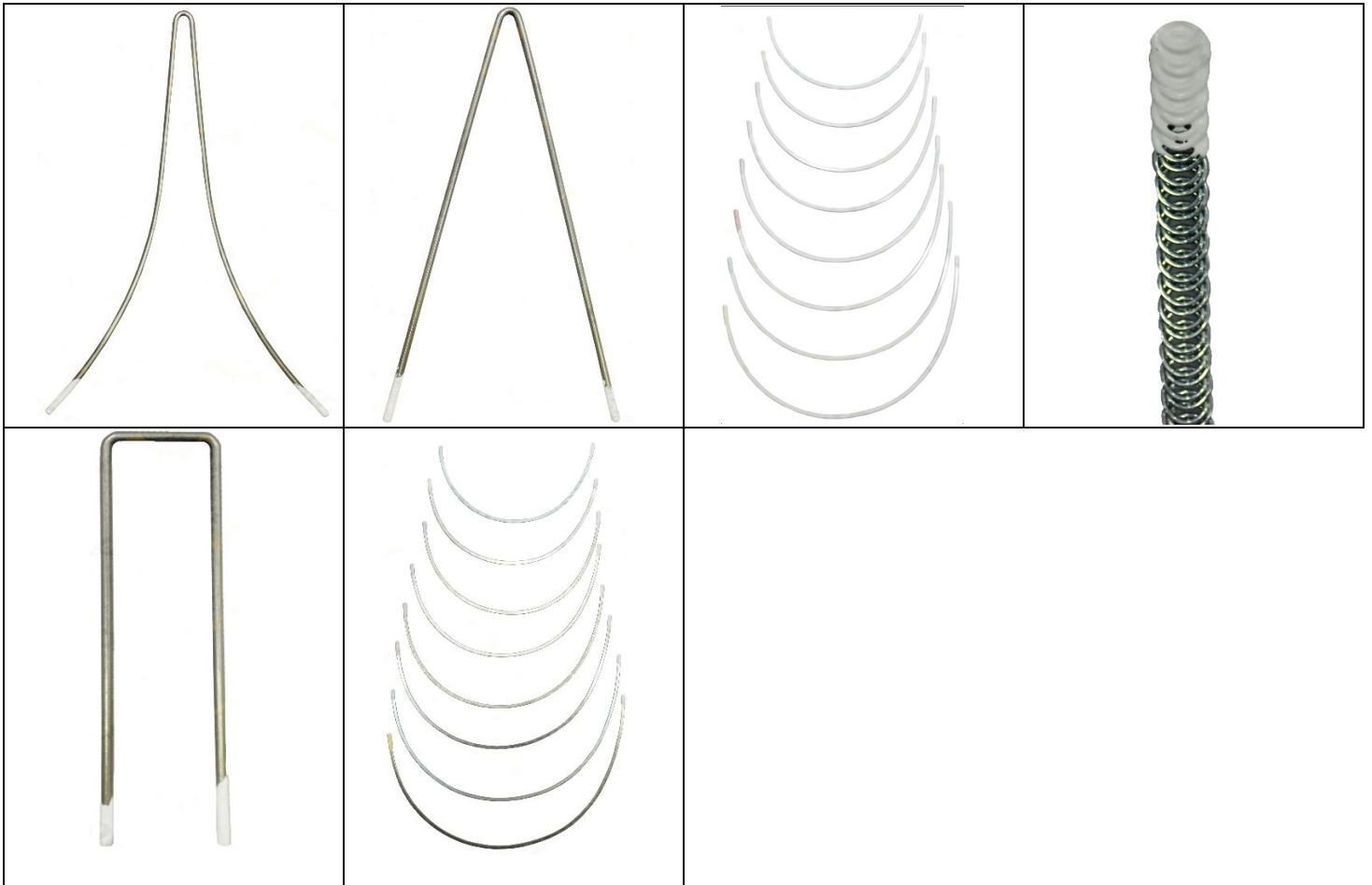

## 5.3 METAL AND PLASTIC SLIDERS FOR BRASSIERE



\* The products can be produced from 8 mm to 25 mm. Our products can be painted in any color you wish.

## 5.4 TEXTILE NEEDLES

\* Please contact us for your special requests.

## 5.5 SHIRT CLIPS



1.10 33 Mm Pressed Stainless  
Medium



30 mm Brass Nickel Plated



33 mm Stainless Short Leg













33mm Brass Nickel Plated

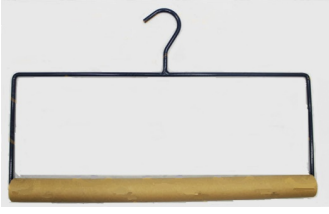

Double Size Shirt Clip

## 6.1 WIRE HANGERS

 <p><b>M103</b> Knotless collar shape M-103Z with ball at the end of the hook M-103ZZ with ball at the end of the hook and the head</p>	 <p><b>M104</b> Knotless collar shape M-104Z with ball at the end of the hook M-104ZZ with ball at the end of the hook and the head</p>	 <p><b>M106</b> Knotless collar shape M-106Z with ball at the end of the hook M-106ZZ with ball at the end of the hook and the head</p>	 <p><b>M107</b> Knotless collar shape M-107Z with ball at the end of the hook M-107ZZ with ball at the end of the hook and the head</p>
 <p><b>M108Z</b> ø 2.00 45 cm lenght Collar shape with knot</p>	 <p><b>M109Z</b> ø 2,00, 45 cm lenght Collar shape without knot</p>	 <p><b>M115</b> ø 3.00 Collar Shape without knot for Tunnel Finisher</p>	 <p><b>M116</b> ø 3.00 Collar Shape without knot for Tunnel Finisher</p>
 <p>Cylinder Curtain Hanger</p>	 <p>COATED</p>	 <p>CYLINDER WIRE HANGER</p>	<p>* All wire hanger forms can be made from ø 1,80 mm to ø 3,00 mm wire thickness. * Standard length is 40cm. Please ask for different length. All wire hangers can be coated upon request.</p>

## 6.2 WIREFORMING





## 6.3- BANDFORMING

## 6.4- CUTTING MOLD

## 6.5- U FORM HOOKS

\* Please contact us for your special requests.

## 6.6 S FORM HOOKS

 <p>S Form Hooks</p>	 <p>S1</p>	 <p>S2</p>
 <p>FLAT</p>	 <p>CONVENTIONAL</p>	<p><b>* Please contact us for your special requests.</b></p> <p><b>* Surface coating options: Zinc, Black Zinc, Nickel, Matt Nickel, Satin, Yellow Zinc, Yellow Passivation Zinc, Electro Ferritic Coating, Brass Coating, Copper Coating and Electrostatic Powder Coating</b></p>

## 6.7 TRANSPORT RINGS

 <p>6 mm WEIGHT RING</p>	 <p>7 mm WEIGHT RING</p>	 <p>8 mm WEIGHT RING</p>
---	---	---

## 6.8 LABEL CLIPS

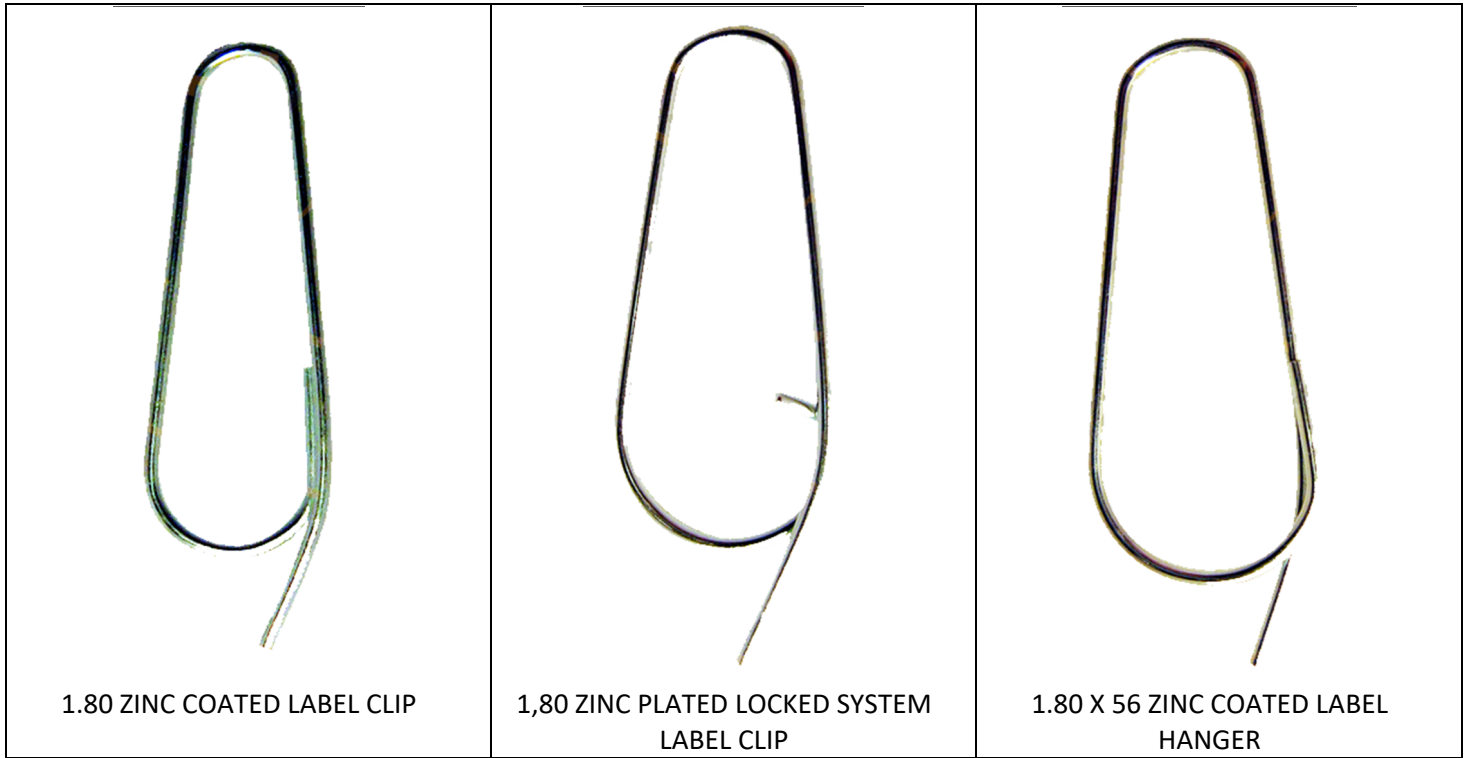

## 7. STATIONARY

*andora*

### 7.1 PAPER CLIP

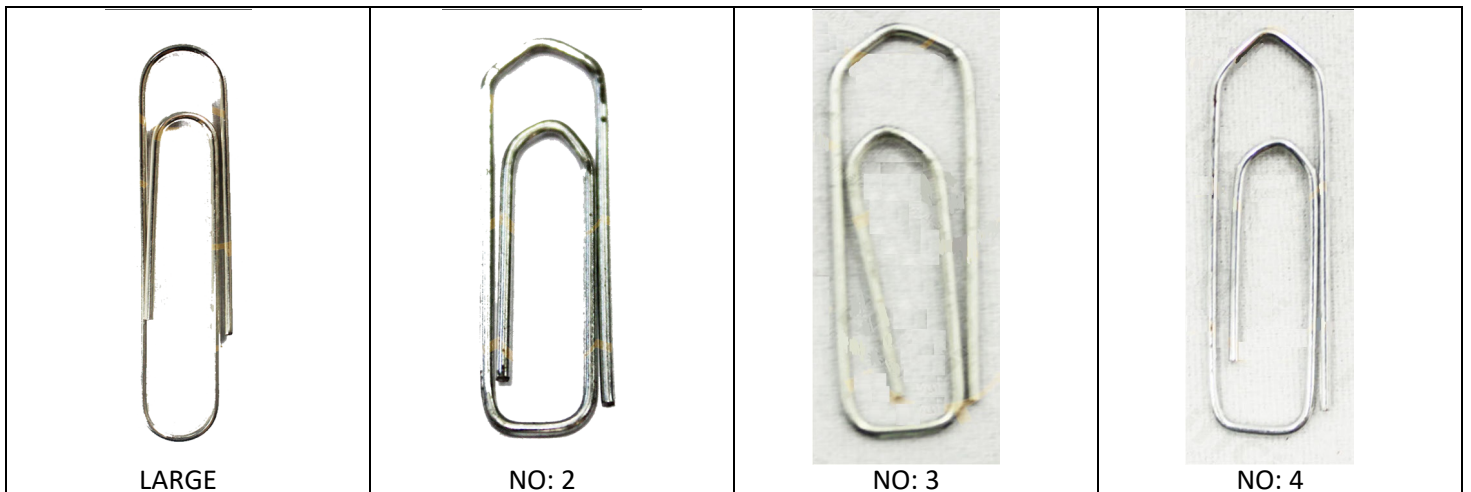

## 7.2 PAPER PINS

 <p data-bbox="335 638 566 672">No 20-24-28-32-34</p>	<p data-bbox="869 190 1117 224"><b>No 20: 0,60 x 20 mm</b></p> <p data-bbox="869 257 1117 291"><b>No 24: 0,65 x 24 mm</b></p> <p data-bbox="869 324 1117 358"><b>No 28: 0,70 x 28 mm</b></p> <p data-bbox="869 392 1117 425"><b>No 32: 0,70 x 32 mm</b></p> <p data-bbox="869 459 1117 492"><b>No 34: 0,65 x 34 mm</b></p>
--	--

## 8. BALL CHAINS

*andora*

 <p data-bbox="95 1456 399 1523"><b>IRON NICKEL BALL CHAIN</b> 1.5 mm- 8.00 mm</p>	 <p data-bbox="494 1456 782 1523"><b>BRASS BALL CHAIN</b> 1.5 mm- 8.00 mm</p>	 <p data-bbox="821 1456 1157 1523"><b>BRASS NICKEL BALL CHAIN</b> 1.5 mm- 8.00 mm</p>	 <p data-bbox="1300 1456 1396 1489"><b>CLIPS 1</b></p>
 <p data-bbox="199 1758 295 1792"><b>CLIPS 2</b></p>	 <p data-bbox="558 1758 678 1792"><b>CLAMP 2</b></p>	 <p data-bbox="845 1758 1117 1792"><b>BALL CHAIN COLOURS</b></p>	<p data-bbox="1181 1534 1484 1668"><b>1.5mm-8mm</b> <b>5 cm-25 cm ballchains</b> <b>can be plated in colours</b> <b>as shown.</b></p>





SPRING 1



SPRING 2

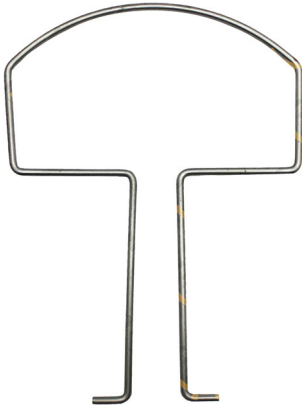

SPRING 3



SPRING 4



SPRING 5



SPRING 6



SPRING 7



SPRING 8



SPRING 9



SPRING 10

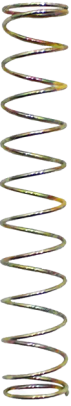

SPRING 11



SPRING 12



SPRING 13



SPRING 14

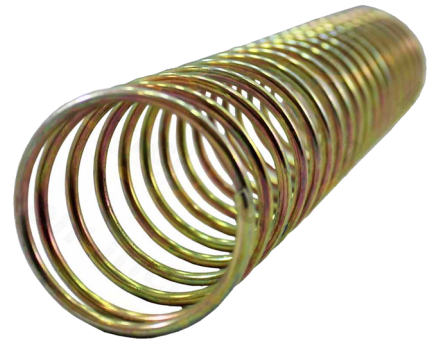

SPRING 15



SPRING 16



SPRING 17



SPRING 18



SPRING 19



SPRING 20



SPRING 21

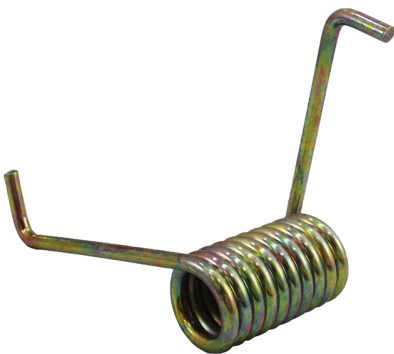

SPRING 22



SPRING 23



SPRING 24



SPRING 25



SPRING 26



SPRING 27



SPRING 28

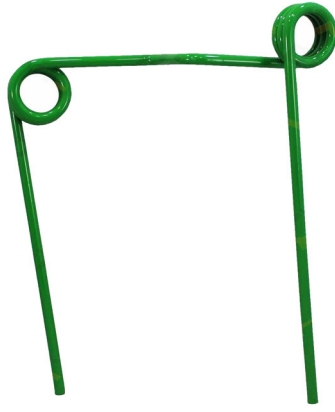

SPRING 29



SPRING 30



SPRING 31

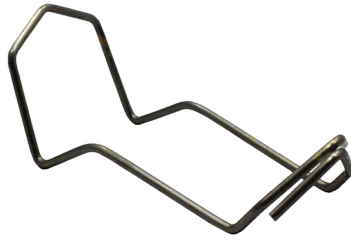

SPRING 32



SPRING 33

## 10. GREENHOUSE ACCESSORIES

*andora*

### 10.1 AGRICULTURAL HOOKS

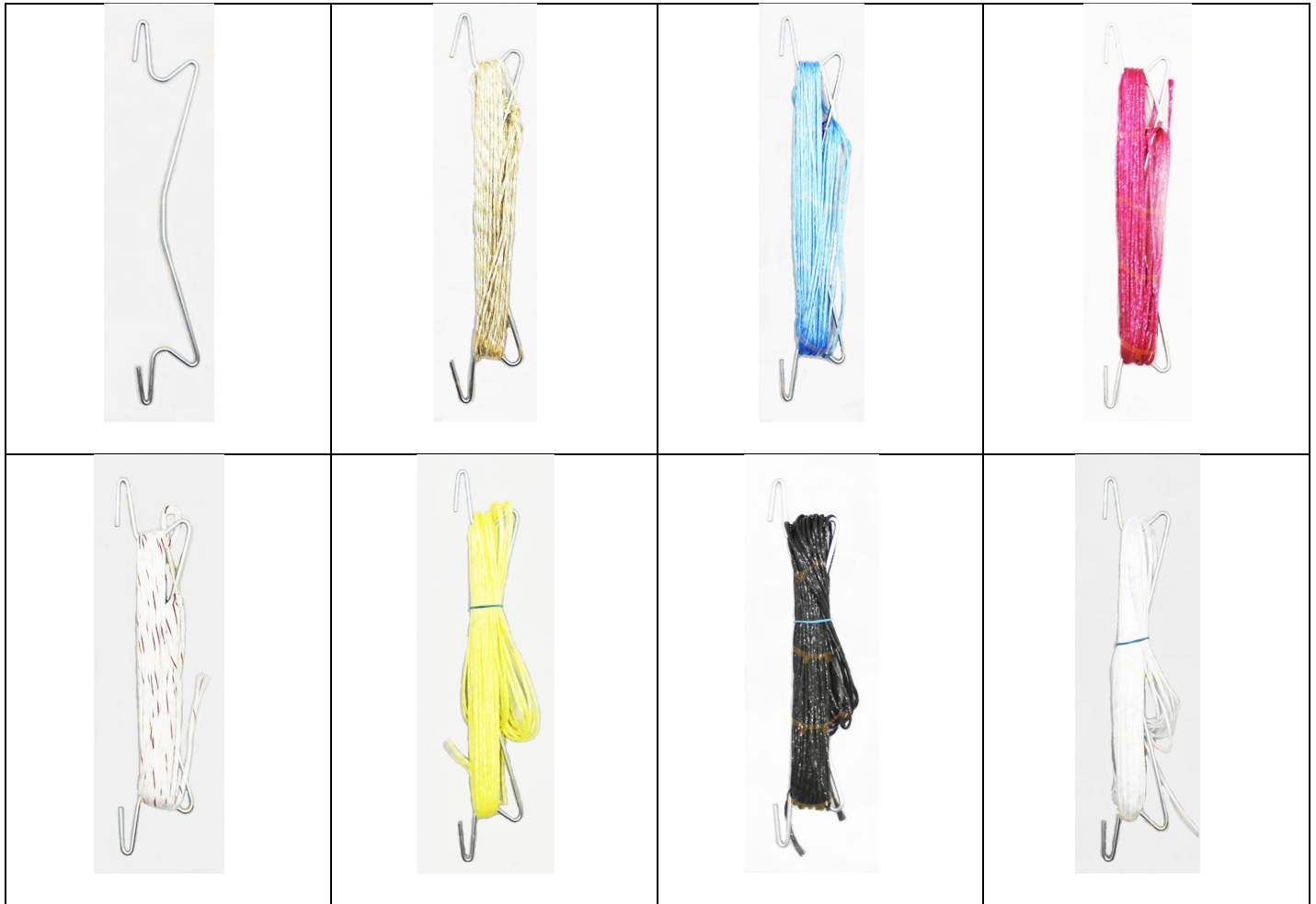

## 11. WIRES

*andora*

**11.1- PAINTED WIRE**

**11.2- NYLON COATED WIRE**

**11.3- PET COATED WIRE**

**11.4- PET COATED FLAT WIRE**

**11.5- BRASS COATED WIRE**

\* Please contact us for your special requests.

## 12.1 CRATE CLIPS

			
ANGEL CLIP	ANNA CLIP	BOLT	EMILIE CLIP
			
INGRID CLIP	JULE CLIP WITH NOSE	CRATE HOOK NO 4	CRATE HOOK NO 7

- **Surface Coating Options: Uncoated, zinc coated, electrostatic powder coating**

## 13.1 SNAP-IN INSTALLATION CLIP



SNAP-IN INSTALLATION CLIP FOR 37 mm

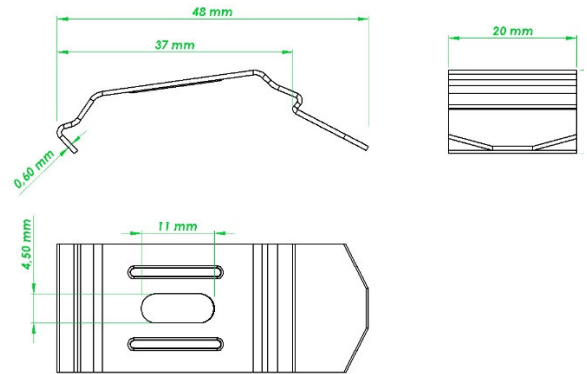

SNAP-IN INSTALLATION CLIP FOR 40 mm

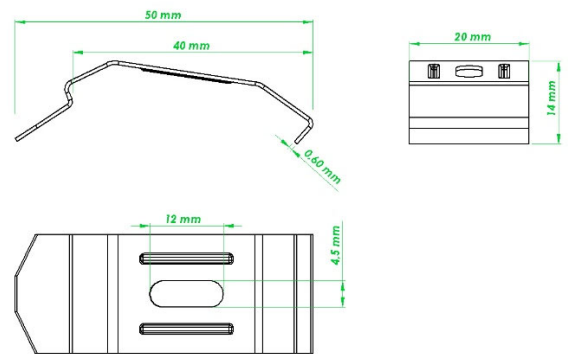

SNAP-IN INSTALLATION CLIP FOR 46 mm

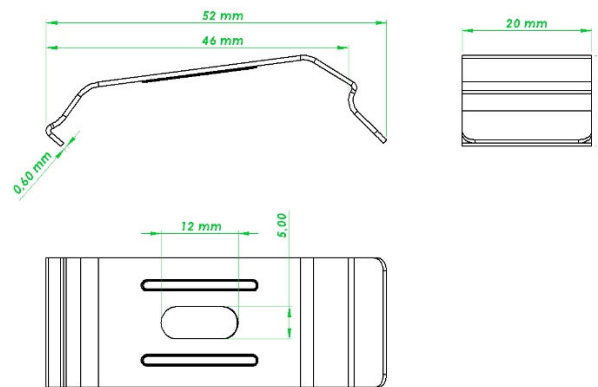



SNAP-IN INSTALLATION CLIP FOR 44 mm

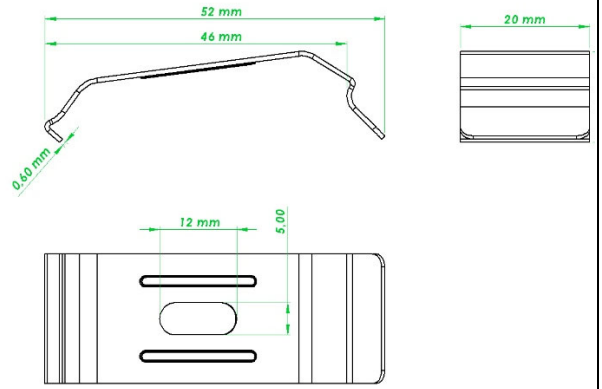

SNAP-IN INSTALLATION CLIP FOR 51 mm

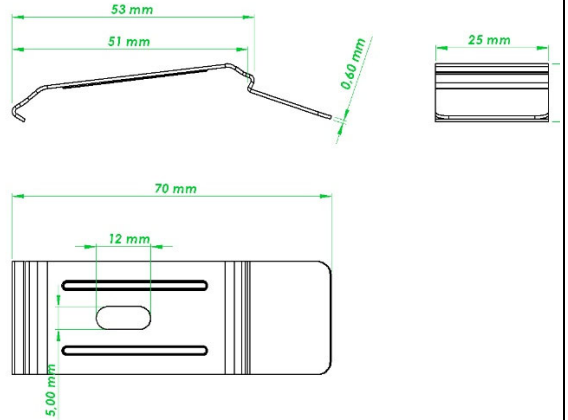

### 13.2 METAL L BRACKET

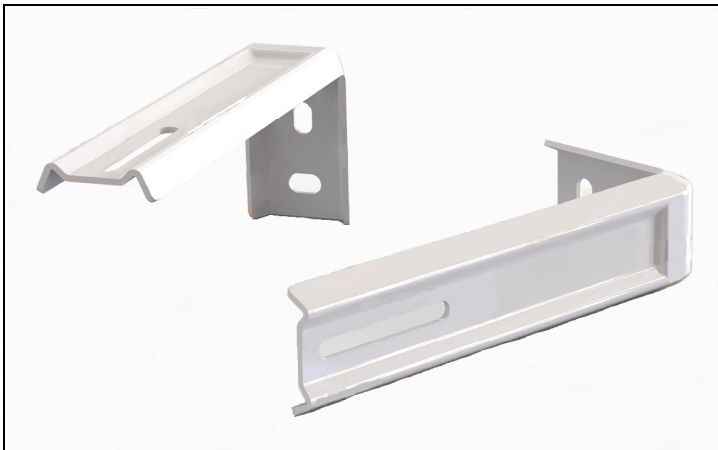

ZINC – PAINTED METAL L BRACKET  
NO:8 – NO:10 – NO:12 – NO:14

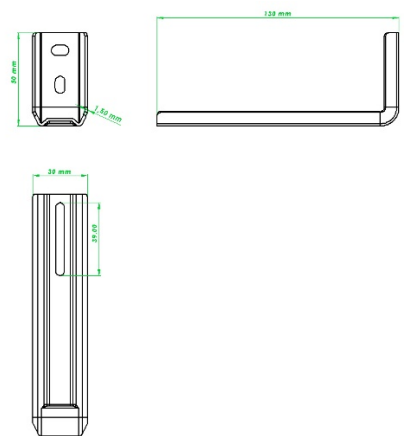

# 13.3 BRACKET SET FOR CURTAIN TRACK



NARROW MODEL BRACKET SET FOR CURTAIN TRACK  
RIGH PR05 1

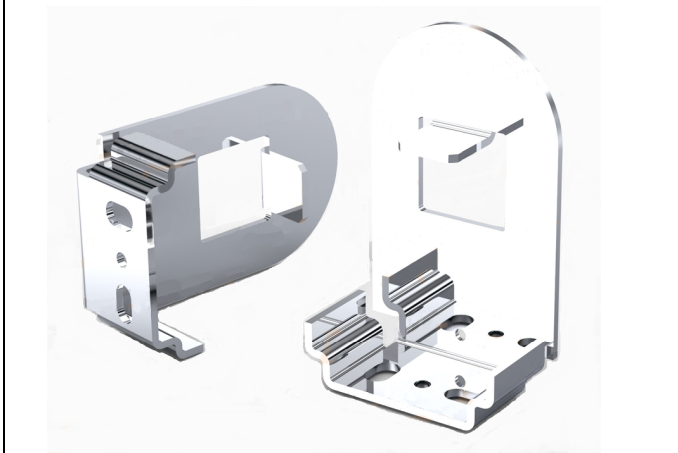
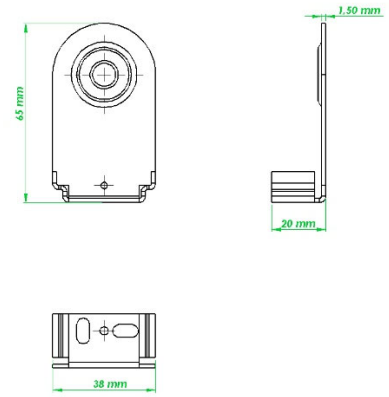

NARROW MODEL BRACKET SET FOR CURTAIN TRACK  
LEFT PR05 2

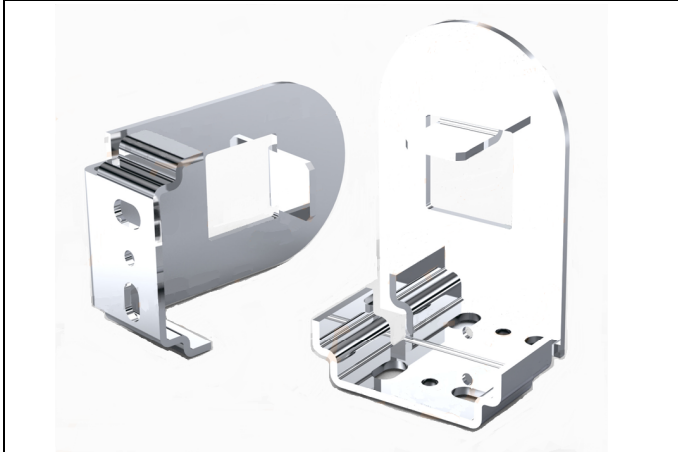
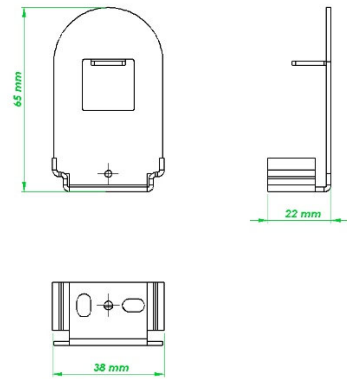

WIDE AND LONG MODEL BRACKET SET FOR  
CURTAIN TRACK

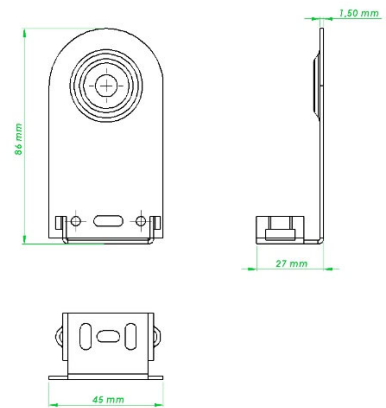



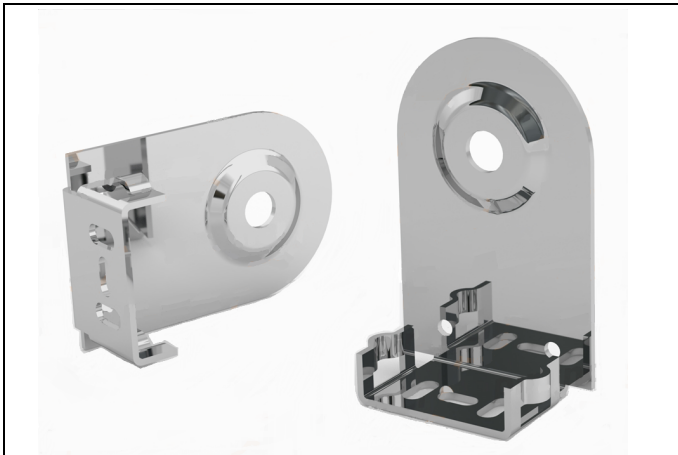

WIDE MODEL BRACKET SET FOR CURTAIN TRACK

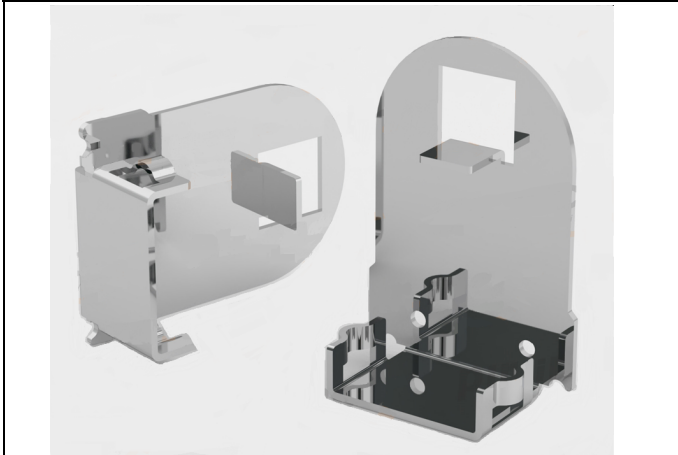

WIDE MODEL BRACKET SET FOR CURTAIN TRACK

### 13.4 DEMOUNTABLE CURTAIN TRACK

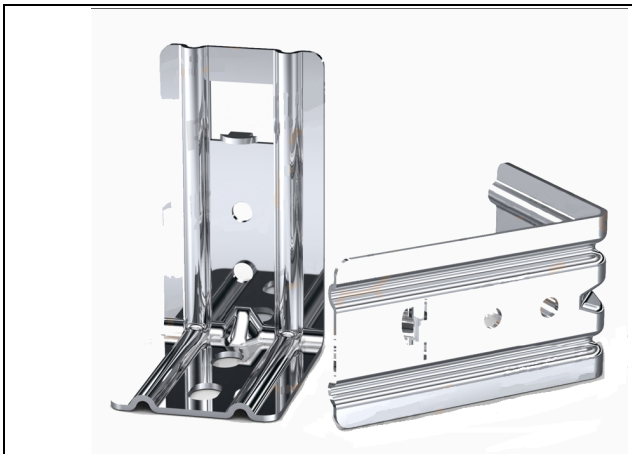

NO:8 ZINC – PAINTED METAL CURTAIN TRACK

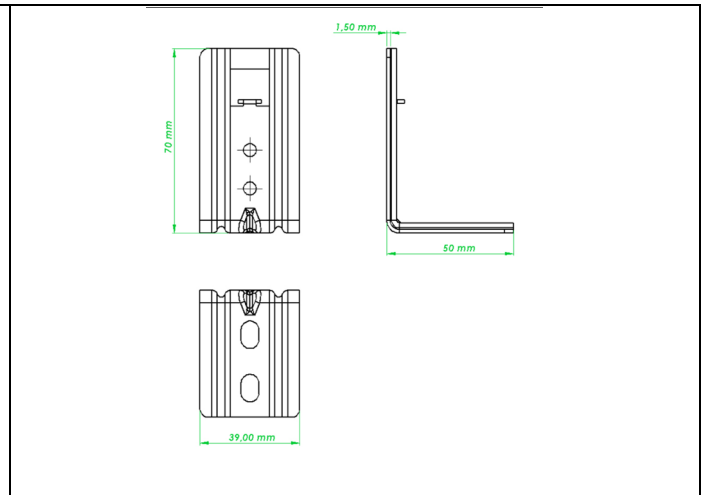

NO:10 ZINC – PAINTED METAL CURTAIN TRACK

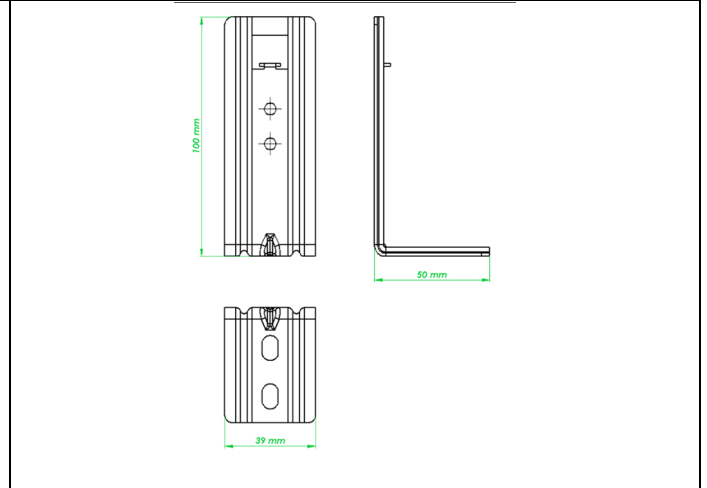



NO:12 ZINC – METAL CURTAIN TRACK

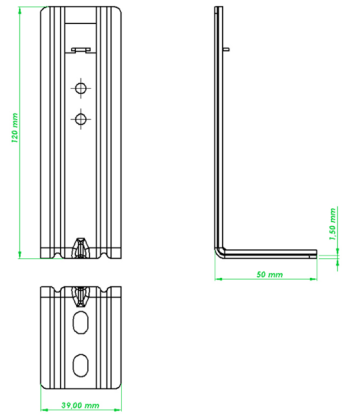

NO:14 ZINC – PAINTED METAL CURTAIN TRACK

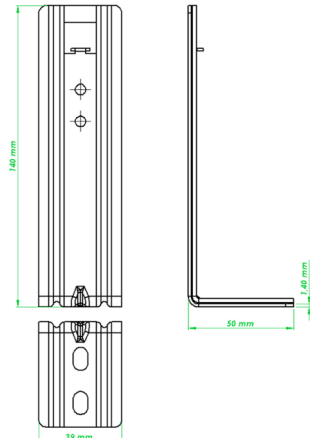

CURTAIN TRACK: PR9-1



CURTAIN TRACK: PR9-2



CURTAIN TRACK: PR9-3

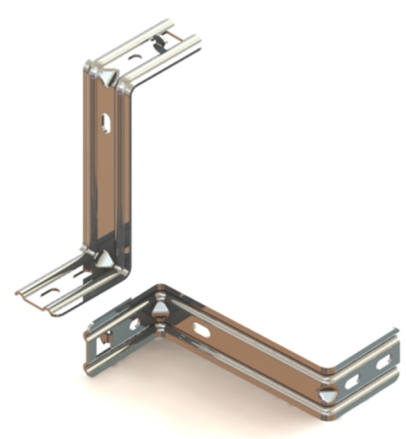

CURTAIN TRACK: PR9-4